

Trench gate field-stop, 650 V, 20 A, M series low-loss IGBT

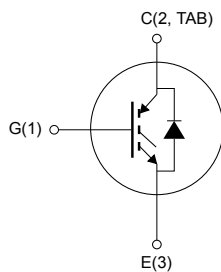

NG1E3C2T

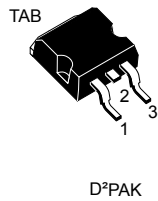

Product status link

[STGB20M65DF2](#)

Product summary

Order code	STGB20M65DF2
Marking	G20M65DF2
Package	D ² PAK
Packing	Tape and reel

Features

- High short-circuit withstand time
- $V_{CE(sat)} = 1.55 \text{ V (typ.) @ } I_C = 20 \text{ A}$
- Tight parameters distribution
- Safer paralleling
- Low thermal resistance
- Soft and very fast recovery antiparallel diode

Applications

- Motor control
- UPS
- PFC
- General-purpose inverters

Description

This device is an IGBT developed using an advanced proprietary trench gate field-stop structure. The device is part of the M series IGBTs, which represent an optimal balance between inverter system performance and efficiency where the low-loss and the short-circuit functionality is essential. Furthermore, the positive $V_{CE(sat)}$ temperature coefficient and the tight parameter distribution result in safer paralleling operation.

1 Electrical ratings

Table 1. Absolute maximum ratings

Symbol	Parameter	Value	Unit
V_{CES}	Collector-emitter voltage ($V_{GE} = 0$)	650	V
I_C	Continuous collector current at $T_C = 25\text{ °C}$	40	A
	Continuous collector current at $T_C = 100\text{ °C}$	20	A
$I_{CP}^{(1)}$	Pulsed collector current	80	A
V_{GE}	Gate-emitter voltage	± 20	V
I_F	Continuous forward current at $T_C = 25\text{ °C}$	40	A
	Continuous forward current at $T_C = 100\text{ °C}$	20	A
$I_{FP}^{(1)}$	Pulsed forward current	80	A
P_{TOT}	Total dissipation at $T_C = 25\text{ °C}$	166	W
T_{STG}	Storage temperature range	-55 to 150	°C
T_J	Operating junction temperature range	-55 to 175	°C

1. Pulse width limited by maximum junction temperature.

Table 2. Thermal data

Symbol	Parameter	Value	Unit
R_{thJC}	Thermal resistance junction-case IGBT	0.9	°C/W
R_{thJC}	Thermal resistance junction-case diode	2.08	°C/W
R_{thJA}	Thermal resistance junction-ambient	62.5	°C/W

2 Electrical characteristics

$T_C = 25\text{ °C}$ unless otherwise specified

Table 3. Static characteristics

Symbol	Parameter	Test conditions	Min.	Typ.	Max.	Unit
$V_{(BR)CES}$	Collector-emitter breakdown voltage	$V_{GE} = 0\text{ V}, I_C = 250\text{ }\mu\text{A}$	650			V
$V_{CE(sat)}$	Collector-emitter saturation voltage	$V_{GE} = 15\text{ V}, I_C = 20\text{ A}$		1.55	2.0	V
		$V_{GE} = 15\text{ V}, I_C = 20\text{ A}, T_J = 125\text{ °C}$		1.95		
		$V_{GE} = 15\text{ V}, I_C = 20\text{ A}, T_J = 175\text{ °C}$		2.1		
V_F	Forward on-voltage	$I_F = 20\text{ A}$		1.85		V
		$I_F = 20\text{ A}, T_J = 125\text{ °C}$		1.65		
		$I_F = 20\text{ A}, T_J = 175\text{ °C}$		1.55		
$V_{GE(th)}$	Gate threshold voltage	$V_{CE} = V_{GE}, I_C = 500\text{ }\mu\text{A}$	5	6	7	V
I_{CES}	Collector cut-off current	$V_{GE} = 0\text{ V}, V_{CE} = 650\text{ V}$			25	μA
I_{GES}	Gate-emitter leakage current	$V_{CE} = 0\text{ V}, V_{GE} = \pm 20\text{ V}$			250	nA

Table 4. Dynamic characteristics

Symbol	Parameter	Test conditions	Min.	Typ.	Max.	Unit
C_{ies}	Input capacitance	$V_{CE} = 25\text{ V}, f = 1\text{ MHz}, V_{GE} = 0\text{ V}$	-	1688	-	pF
C_{oes}	Output capacitance		-	95	-	
C_{res}	Reverse transfer capacitance		-	35	-	
Q_g	Total gate charge	$V_{CC} = 520\text{ V}, I_C = 20\text{ A},$	-	63	-	nC
Q_{ge}	Gate-emitter charge	$V_{GE} = 0\text{ to }15\text{ V}$	-	15	-	
Q_{gc}	Gate-collector charge	(see Figure 29. Gate charge test circuit)	-	26	-	

Table 5. IGBT switching characteristics (inductive load)

Symbol	Parameter	Test conditions	Min.	Typ.	Max.	Unit	
$t_{d(on)}$	Turn-on delay time	$V_{CE} = 400\text{ V}$, $I_C = 20\text{ A}$, $V_{GE} = 15\text{ V}$, $R_G = 12\ \Omega$ (see Figure 28. Test circuit for inductive load switching)		26	-	ns	
t_r	Current rise time			10.8	-	ns	
$(di/dt)_{on}$	Turn-on current slope			1409	-	A/ μs	
$t_{d(off)}$	Turn-off delay time			108	-	ns	
t_f	Current fall time			65	-	ns	
$E_{on}^{(1)}$	Turn-on switching energy			0.14	-	mJ	
$E_{off}^{(2)}$	Turn-off switching energy			0.56	-	mJ	
E_{ts}	Total switching energy			0.7	-	mJ	
$t_{d(on)}$	Turn-on delay time		$V_{CE} = 400\text{ V}$, $I_C = 20\text{ A}$, $V_{GE} = 15\text{ V}$, $R_G = 12\ \Omega$, $T_J = 175\text{ }^\circ\text{C}$ (see Figure 28. Test circuit for inductive load switching)		28.4	-	ns
t_r	Current rise time				11.2	-	ns
$(di/dt)_{on}$	Turn-on current slope			1393	-	A/ μs	
$t_{d(off)}$	Turn-off delay time			107	-	ns	
t_f	Current fall time			145	-	ns	
$E_{on}^{(1)}$	Turn-on switching energy			0.3	-	mJ	
$E_{off}^{(2)}$	Turn-off switching energy			0.85	-	mJ	
E_{ts}	Total switching energy			1.15	-	mJ	
t_{sc}	Short-circuit withstand time	$V_{CC} = 400\text{ V}$, $V_{GE} = 13\text{ V}$, $T_{Jstart} = 150\text{ }^\circ\text{C}$		10		-	μs
		$V_{CC} = 400\text{ V}$, $V_{GE} = 15\text{ V}$, $T_{Jstart} = 150\text{ }^\circ\text{C}$		6		-	

1. Including the reverse recovery of the diode.

2. Including the tail of the collector current.

Table 6. Diode switching characteristics (inductive load)

Symbol	Parameter	Test conditions	Min.	Typ.	Max.	Unit	
t_{rr}	Reverse recovery time	$I_F = 20\text{ A}$, $V_R = 400\text{ V}$, $V_{GE} = 15\text{ V}$, $di/dt = 1000\text{ A}/\mu\text{s}$ (see Figure 28. Test circuit for inductive load switching)	-	166		ns	
Q_{rr}	Reverse recovery charge			-	690		nC
I_{rrm}	Reverse recovery current			-	13.2		A
dI_{rr}/dt	Peak rate of fall of reverse recovery current during t_b			-	769		A/ μs
E_{rr}	Reverse recovery energy			-	81		μJ
t_{rr}	Reverse recovery time		$I_F = 20\text{ A}$, $V_R = 400\text{ V}$, $V_{GE} = 15\text{ V}$, $T_J = 175\text{ }^\circ\text{C}$, $di/dt = 1000\text{ A}/\mu\text{s}$ (see Figure 28. Test circuit for inductive load switching)	-	281		ns
Q_{rr}	Reverse recovery charge			-	2010		nC
I_{rrm}	Reverse recovery current			-	19.6		A
dI_{rr}/dt	Peak rate of fall of reverse recovery current during t_b			-	370		A/ μs
E_{rr}	Reverse recovery energy			-	215		μJ

2.1 Electrical characteristics (curves)

Figure 1. Power dissipation vs case temperature

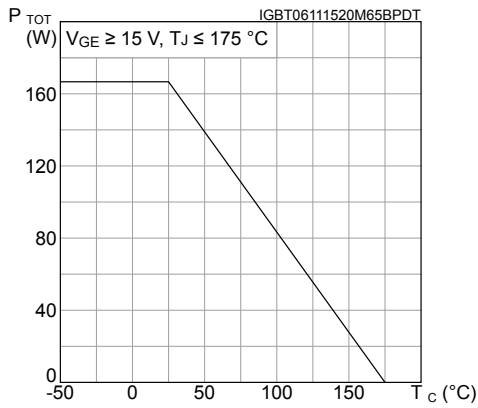

Figure 2. Collector current vs case temperature

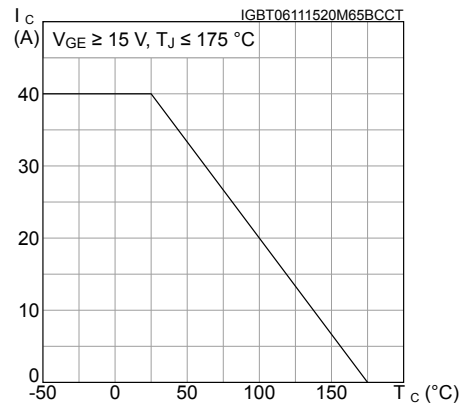

Figure 3. Output characteristics ($T_J = 25\text{ }^\circ\text{C}$)

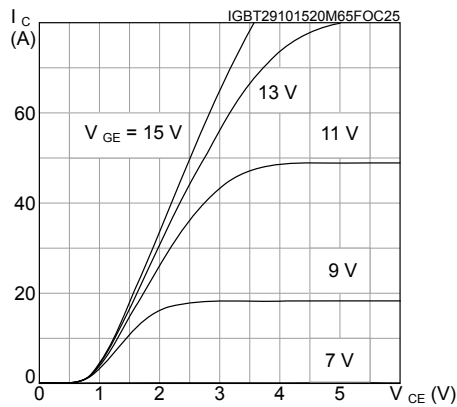

Figure 4. Output characteristics ($T_J = 175\text{ }^\circ\text{C}$)

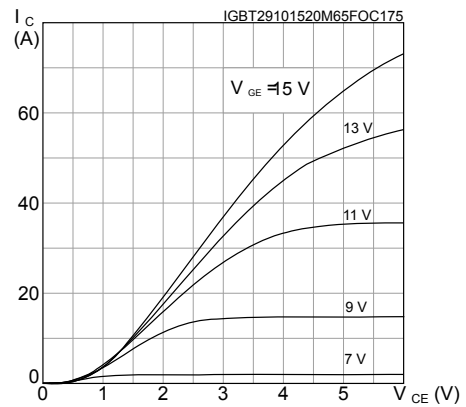

Figure 5. $V_{CE(sat)}$ vs junction temperature

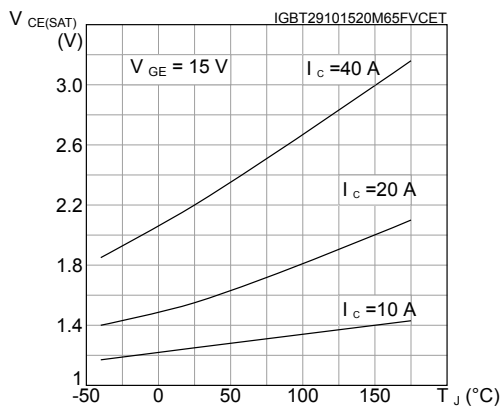

Figure 6. $V_{CE(sat)}$ vs collector current

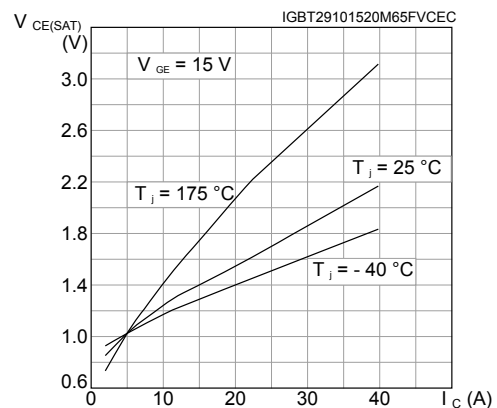

Figure 7. Collector current vs switching frequency

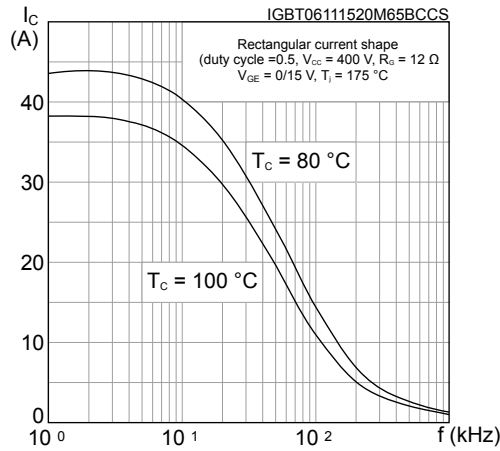

Figure 8. Forward bias safe operating area

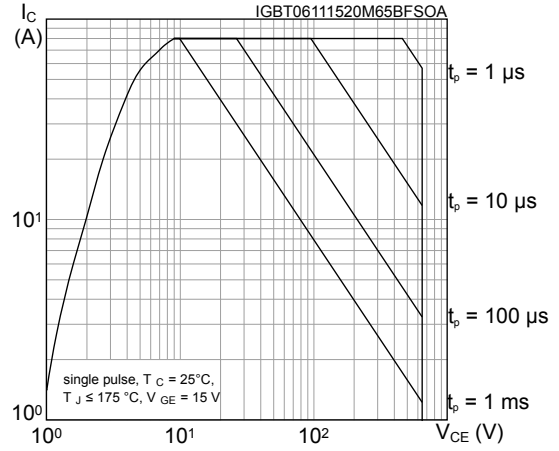

Figure 9. Transfer characteristics

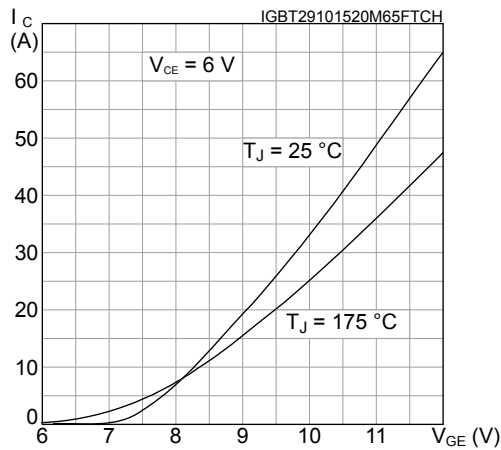

Figure 10. Diode V_F vs forward current

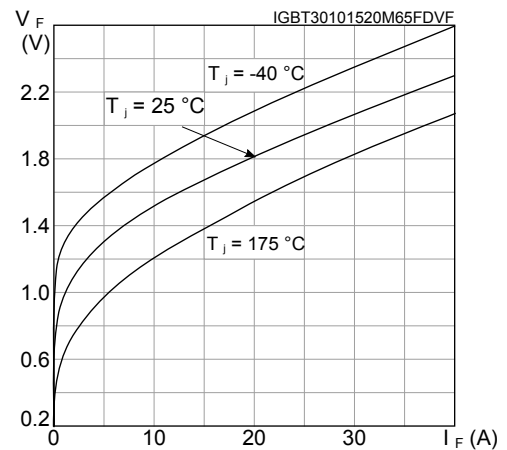

Figure 11. Normalized V_GE(th) vs junction temperature

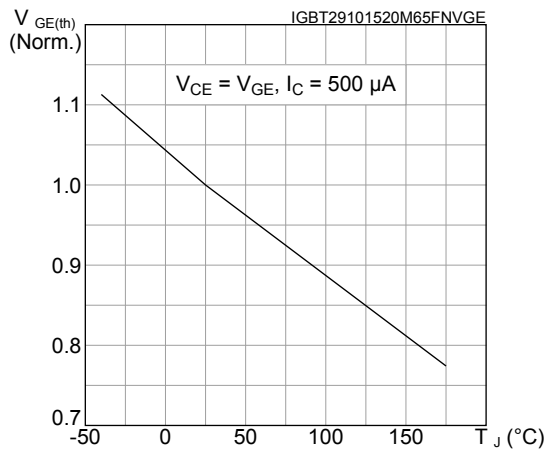

Figure 12. Normalized V_(BR)CES vs junction temperature

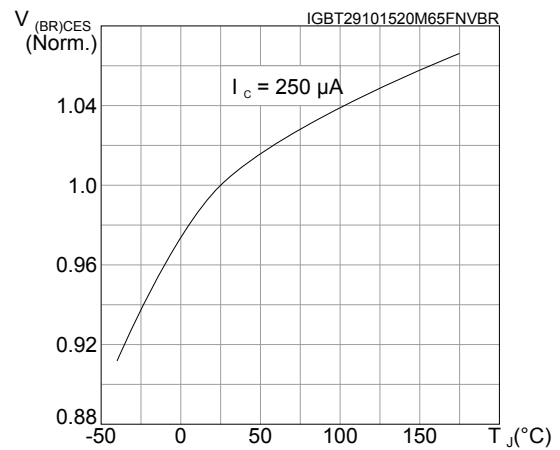

Figure 13. Capacitance variations

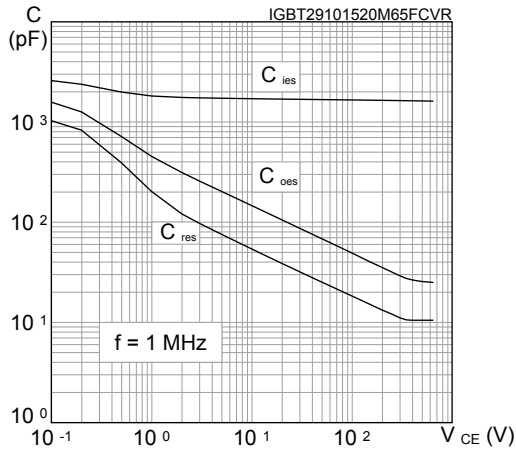

Figure 14. Gate charge vs gate-emitter voltage

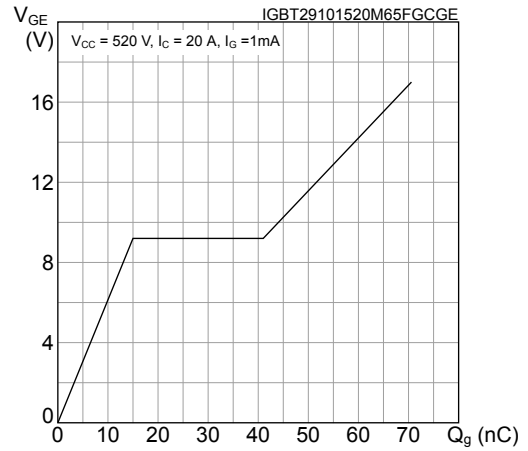

Figure 15. Switching energy vs collector current

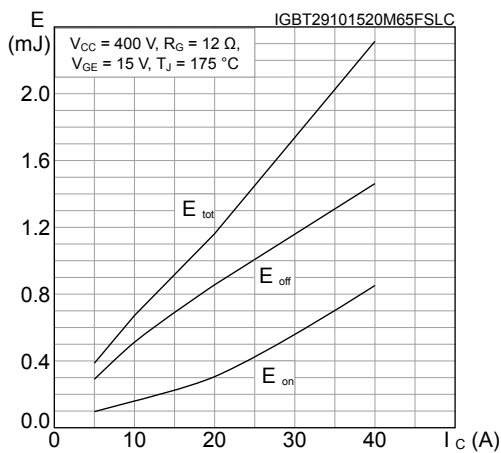

Figure 16. Switching energy vs gate resistance

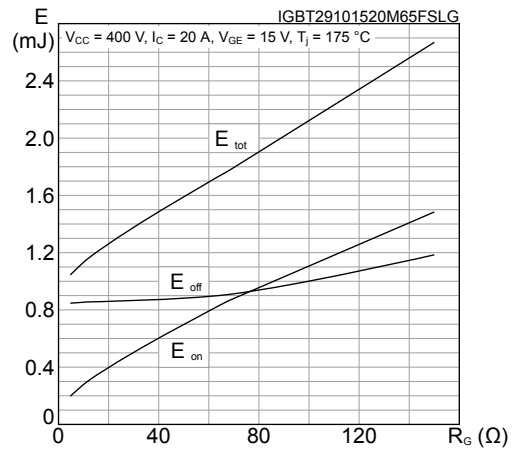

Figure 17. Switching energy vs temperature

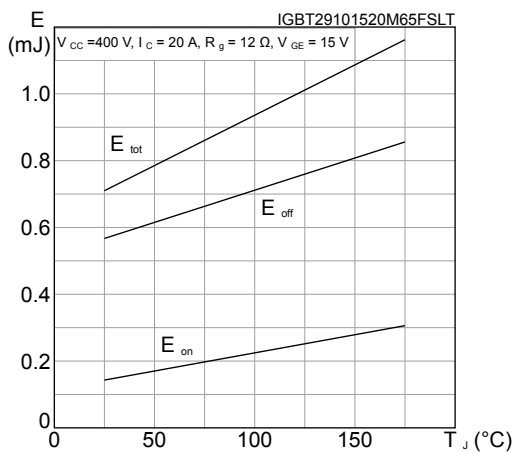

Figure 18. Switching energy vs collector emitter voltage

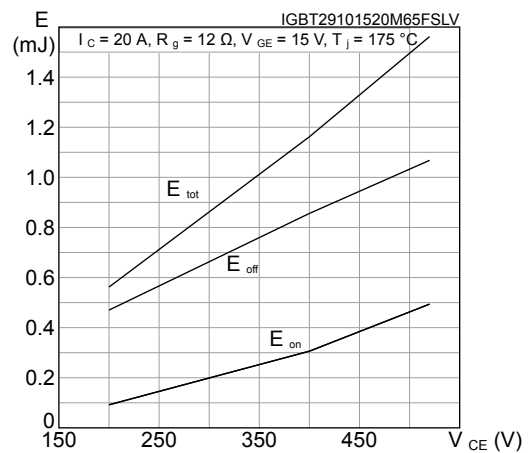

Figure 19. Short-circuit time and current vs V_{GE}

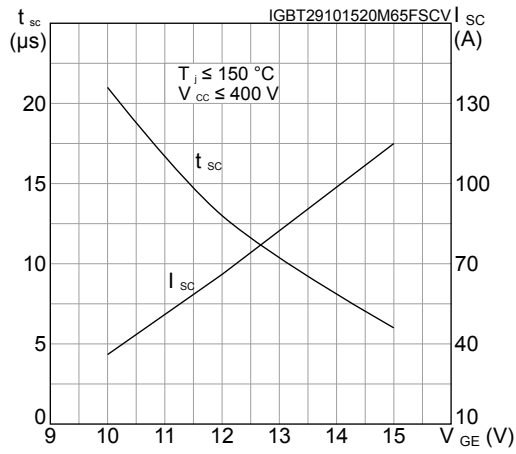

Figure 20. Switching times vs collector current

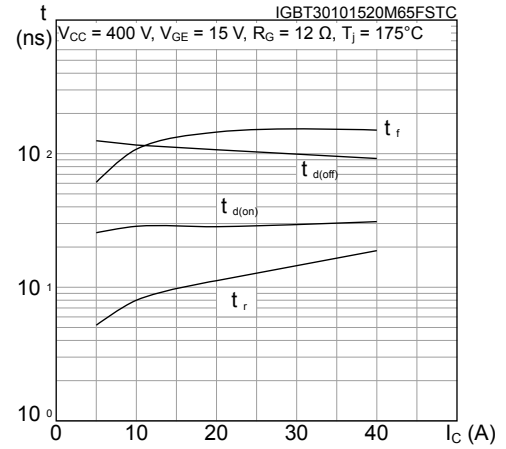

Figure 21. Switching times vs gate resistance

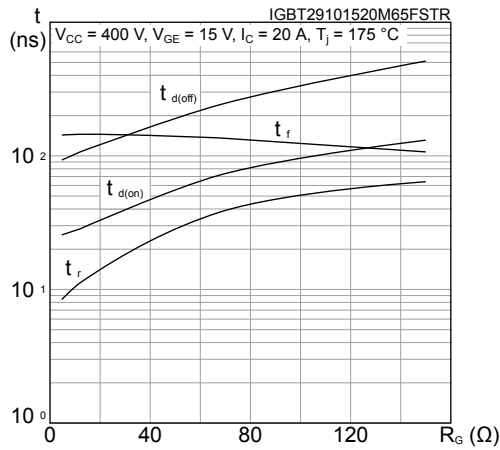

Figure 22. Reverse recovery current vs diode current slope

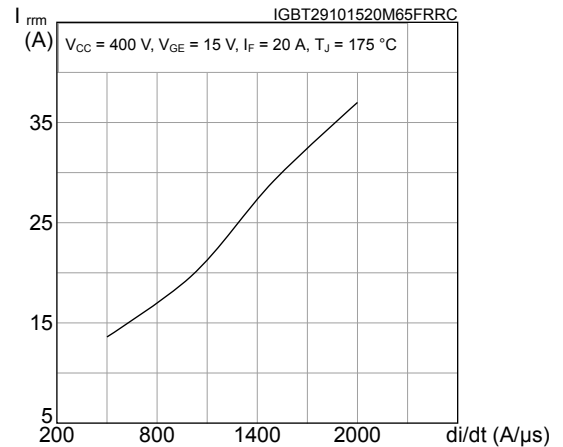

Figure 23. Reverse recovery time vs diode current slope

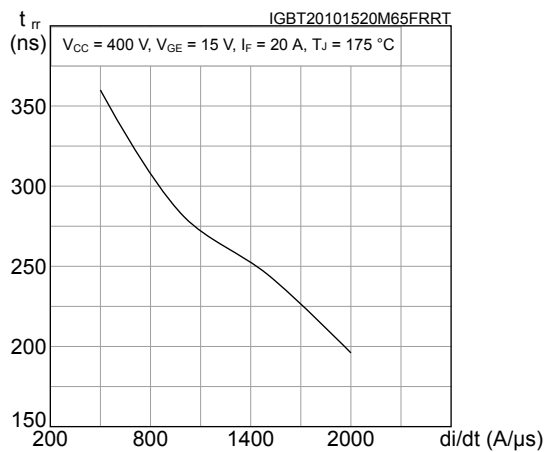

Figure 24. Reverse recovery charge vs diode current slope

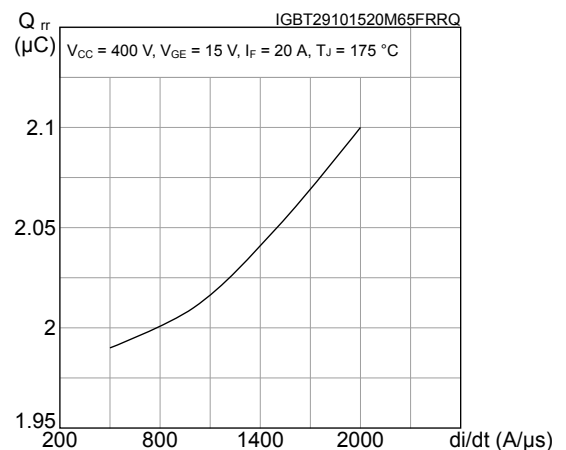

Figure 25. Reverse recovery energy vs diode current slope

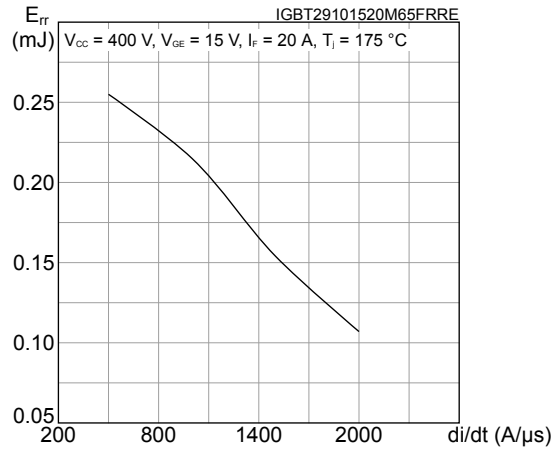

Figure 26. Thermal impedance for IGBT

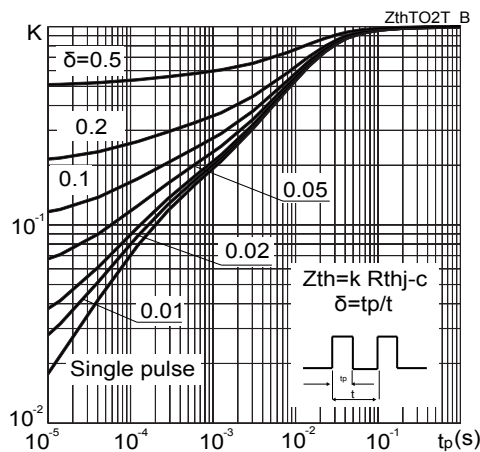
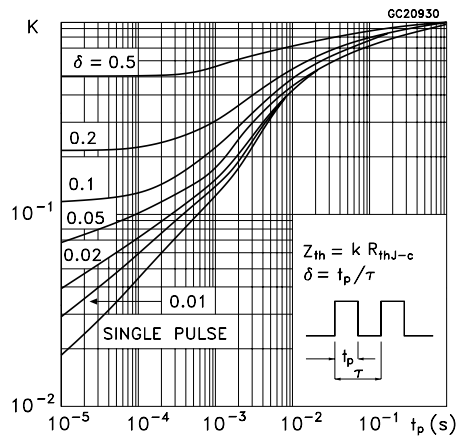
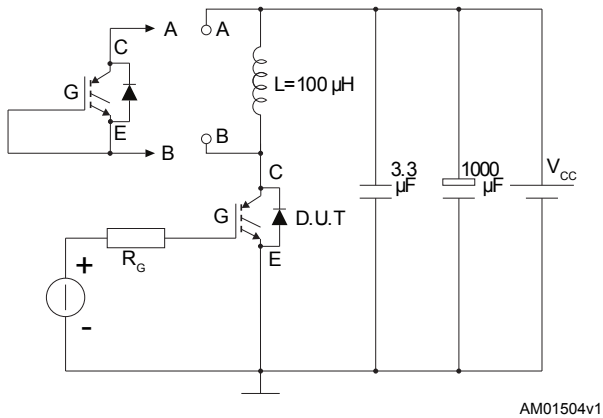
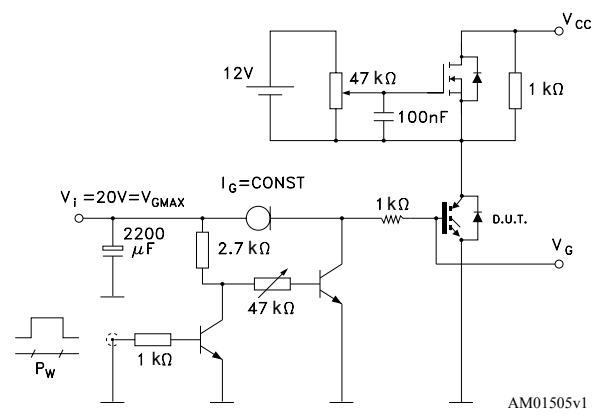
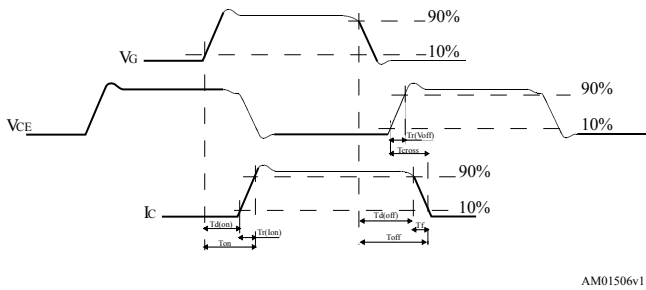
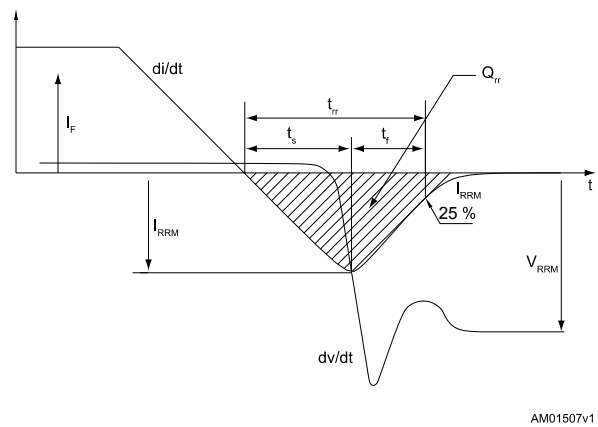

Figure 27. Thermal impedance for diode



3 Test circuits

Figure 28. Test circuit for inductive load switching

Figure 29. Gate charge test circuit

Figure 30. Switching waveform

Figure 31. Diode reverse recovery waveform

4 Package information

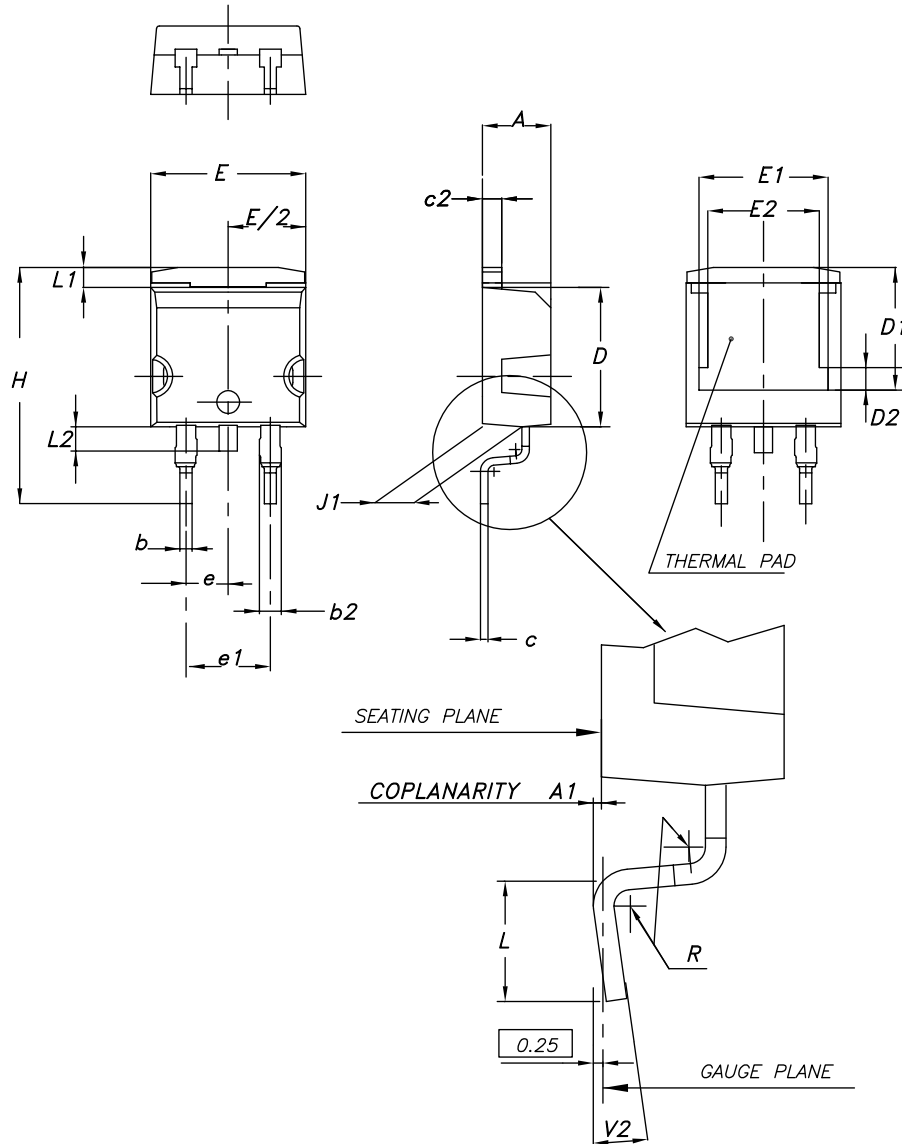
In order to meet environmental requirements, ST offers these devices in different grades of **ECOPACK[®]** packages, depending on their level of environmental compliance. ECOPACK[®] specifications, grade definitions and product status are available at: www.st.com. ECOPACK[®] is an ST trademark.

4.1 D²PAK (TO-263) type A2 package information

Figure 32. D²PAK (TO-263) type A2 package outline



0079457_A2_25

Table 7. D²PAK (TO-263) type A2 package mechanical data

Dim.	mm		
	Min.	Typ.	Max.
A	4.40		4.60
A1	0.03		0.23
b	0.70		0.93
b2	1.14		1.70
c	0.45		0.60
c2	1.23		1.36
D	8.95		9.35
D1	7.50	7.75	8.00
D2	1.10	1.30	1.50
E	10.00		10.40
E1	8.70	8.90	9.10
E2	7.30	7.50	7.70
e		2.54	
e1	4.88		5.28
H	15.00		15.85
J1	2.49		2.69
L	2.29		2.79
L1	1.27		1.40
L2	1.30		1.75
R		0.40	
V2	0°		8°

Figure 33. D²PAK (TO-263) recommended footprint (dimensions are in mm)

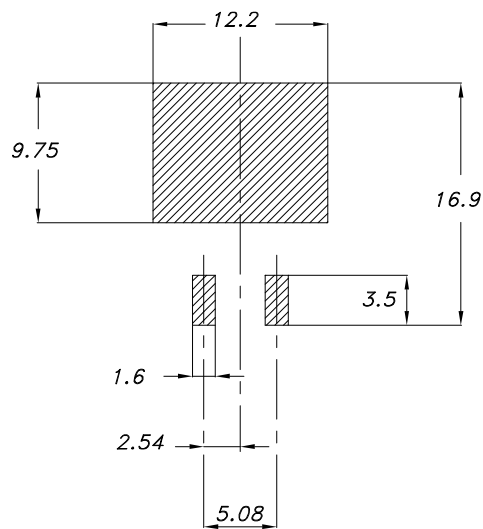

Footprint

4.2 D²PAK packing information

Figure 34. D²PAK tape outline

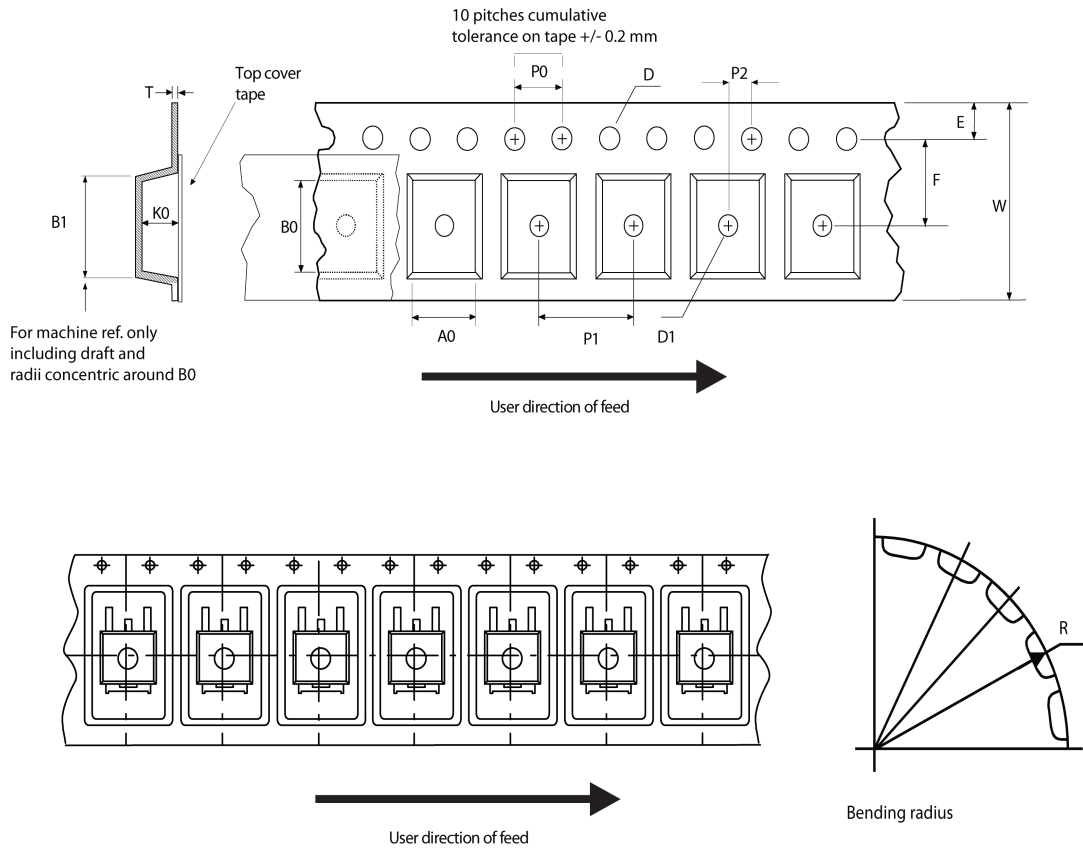

AM08852v1

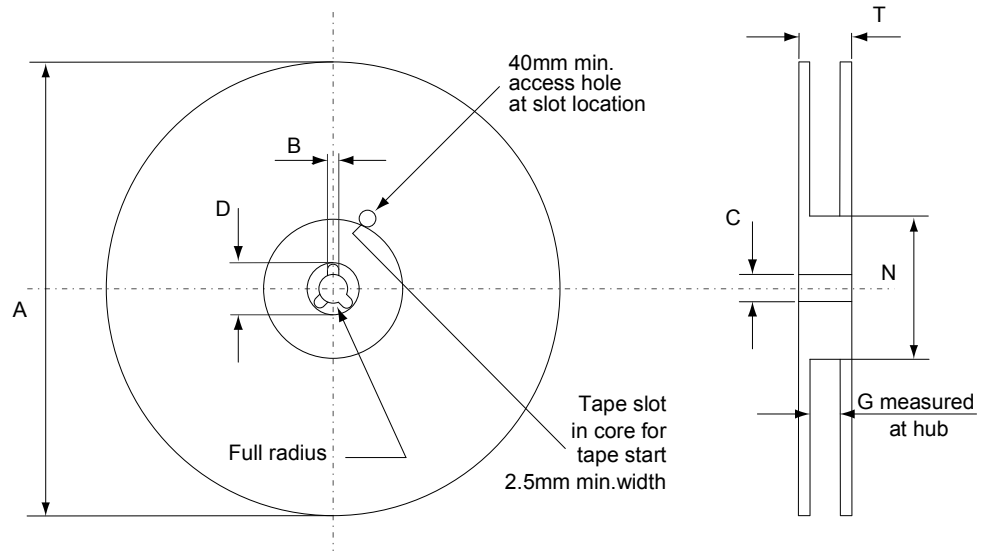
Figure 35. D²PAK reel outline

AM06038v1

Table 8. D²PAK tape and reel mechanical data

Tape			Reel		
Dim.	mm		Dim.	mm	
	Min.	Max.		Min.	Max.
A0	10.5	10.7	A		330
B0	15.7	15.9	B	1.5	
D	1.5	1.6	C	12.8	13.2
D1	1.59	1.61	D	20.2	
E	1.65	1.85	G	24.4	26.4
F	11.4	11.6	N	100	
K0	4.8	5.0	T		30.4
P0	3.9	4.1			
P1	11.9	12.1	Base quantity		1000
P2	1.9	2.1	Bulk quantity		1000
R	50				
T	0.25	0.35			
W	23.7	24.3			

Revision history

Table 9. Document revision history

Date	Revision	Changes
05-Nov-2015	1	First release.
14-Apr-2016	2	Updated <i>Figure 13: "Normalized V(BR)CES vs. junction temperature"</i> . Minor text changes.
08-Oct-2018	3	Updated Table 3. Static characteristics . Minor text changes

Contents

1	Electrical ratings	2
2	Electrical characteristics	3
2.1	Electrical characteristics (curves)	5
3	Test circuits	10
4	Package information	11
4.1	D²PAK (TO-263) type A2 package information	11
4.2	Packing information	13
	Revision history	16
	Contents	17

IMPORTANT NOTICE – PLEASE READ CAREFULLY

STMicroelectronics NV and its subsidiaries (“ST”) reserve the right to make changes, corrections, enhancements, modifications, and improvements to ST products and/or to this document at any time without notice. Purchasers should obtain the latest relevant information on ST products before placing orders. ST products are sold pursuant to ST’s terms and conditions of sale in place at the time of order acknowledgement.

Purchasers are solely responsible for the choice, selection, and use of ST products and ST assumes no liability for application assistance or the design of Purchasers’ products.

No license, express or implied, to any intellectual property right is granted by ST herein.

Resale of ST products with provisions different from the information set forth herein shall void any warranty granted by ST for such product.

ST and the ST logo are trademarks of ST. All other product or service names are the property of their respective owners.

Information in this document supersedes and replaces information previously supplied in any prior versions of this document.

© 2018 STMicroelectronics – All rights reserved