

N-Channel 40-V (D-S) MOSFET

PRODUCT SUMMARY			
V_{DS} (V)	$R_{DS(on)}$ (Ω)	I_D (A) ^a	Q_g (Typ.)
40	0.005 at $V_{GS} = 10$ V	40	24
	0.006 at $V_{GS} = 4.5$ V	40	

FEATURES

- Halogen-free According to IEC 61249-2-21 Definition
- Q_g Optimized
- 100 % R_g Tested
- 100 % UIS Tested
- Compliant to RoHS Directive 2002/95/EC



RoHS
COMPLIANT
HALOGEN
FREE

APPLICATIONS

- DC/DC Conversion
- Industrial

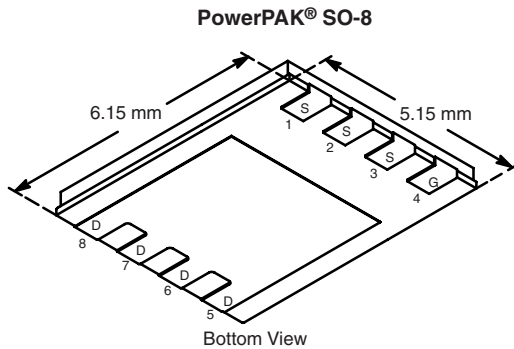

Bottom View

Ordering Information: SiR418DP-T1-GE3 (Lead (Pb)-free and Halogen-free)

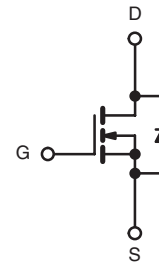

N-Channel MOSFET

ABSOLUTE MAXIMUM RATINGS $T_A = 25$ °C, unless otherwise noted				
Parameter	Symbol	Limit	Unit	
Drain-Source Voltage	V_{DS}	40	V	
Gate-Source Voltage	V_{GS}	± 20		
Continuous Drain Current ($T_J = 150$ °C)	I_D	$T_C = 25$ °C	40 ^a	
		$T_C = 70$ °C	40 ^a	
		$T_A = 25$ °C	23.5 ^{b, c}	
		$T_A = 70$ °C	18.8 ^{b, c}	
Pulsed Drain Current	I_{DM}	70	A	
Continuous Source-Drain Diode Current	I_S	$T_C = 25$ °C		35
		$T_A = 25$ °C		4.5 ^{b, c}
Avalanche Current	I_{AS}	30		mJ
Single-Pulse Avalanche Energy	E_{AS}	45		
Maximum Power Dissipation	P_D	$T_C = 25$ °C	39	
		$T_C = 70$ °C	25	
		$T_A = 25$ °C	5 ^{b, c}	
		$T_A = 70$ °C	3.2 ^{b, c}	
Operating Junction and Storage Temperature Range	T_J, T_{stg}	-55 to 150	°C	
Soldering Recommendations (Peak Temperature) ^{d, e}		260		

THERMAL RESISTANCE RATINGS					
Parameter		Symbol	Typical	Maximum	Unit
Maximum Junction-to-Ambient ^{b, f}	$t \leq 10$ s	R_{thJA}	20	25	°C/W
Maximum Junction-to-Case (Drain)	Steady State	R_{thJC}	2.1	3.2	

Notes:

a. Based on $T_C = 25$ °C. Package limited.

b. Surface mounted on 1" x 1" FR4 board.

c. $t = 10$ s.

d. See Solder Profile (www.vishay.com/doc?73461). The PowerPAK SO-8 is a leadless package. The end of the lead terminal is exposed copper (not plated) as a result of the singulation process in manufacturing. A solder fillet at the exposed copper tip cannot be guaranteed and is not required to ensure adequate bottom side solder interconnection.

e. Rework Conditions: manual soldering with a soldering iron is not recommended for leadless components.

f. Maximum under steady state conditions is 70 °C/W.

SPECIFICATIONS $T_J = 25\text{ }^\circ\text{C}$, unless otherwise noted						
Parameter	Symbol	Test Conditions	Min.	Typ.	Max.	Unit
Static						
Drain-Source Breakdown Voltage	V_{DS}	$V_{GS} = 0\text{ V}$, $I_D = 250\text{ }\mu\text{A}$	40			V
V_{DS} Temperature Coefficient	$\Delta V_{DS}/T_J$	$I_D = 1\text{ }\mu\text{A}$ to $250\text{ }\mu\text{A}$		48		mV/ $^\circ\text{C}$
$V_{GS(th)}$ Temperature Coefficient	$\Delta V_{GS(th)}/T_J$			- 5.6		
Gate-Source Threshold Voltage	$V_{GS(th)}$	$V_{DS} = V_{GS}$, $I_D = 250\text{ }\mu\text{A}$	1.1		2.4	V
Gate-Source Leakage	I_{GSS}	$V_{DS} = 0\text{ V}$, $V_{GS} = \pm 20\text{ V}$			± 100	nA
Zero Gate Voltage Drain Current	I_{DSS}	$V_{DS} = 40\text{ V}$, $V_{GS} = 0\text{ V}$			1	μA
		$V_{DS} = 40\text{ V}$, $V_{GS} = 0\text{ V}$, $T_J = 55\text{ }^\circ\text{C}$			10	
On-State Drain Current ^a	$I_{D(on)}$	$V_{DS} \geq 5\text{ V}$, $V_{GS} = 10\text{ V}$	30			A
Drain-Source On-State Resistance ^a	$R_{DS(on)}$	$V_{GS} = 10\text{ V}$, $I_D = 20\text{ A}$		0.00415	0.005	Ω
		$V_{GS} = 4.5\text{ V}$, $I_D = 15\text{ A}$		0.0048	0.006	
Forward Transconductance ^a	g_{fs}	$V_{DS} = 15\text{ V}$, $I_D = 20\text{ A}$		95		S
Dynamic^b						
Input Capacitance	C_{iss}	$V_{DS} = 20\text{ V}$, $V_{GS} = 0\text{ V}$, $f = 1\text{ MHz}$		2410		pF
Output Capacitance	C_{oss}			371		
Reverse Transfer Capacitance	C_{rss}			141		
Total Gate Charge	Q_g	$V_{DS} = 20\text{ V}$, $V_{GS} = 10\text{ V}$, $I_D = 20\text{ A}$		50	75	nC
		$V_{DS} = 20\text{ V}$, $V_{GS} = 4.5\text{ V}$, $I_D = 20\text{ A}$		24	36	
Gate-Source Charge	Q_{gs}			6.5		
Gate-Drain Charge	Q_{gd}		7.0			
Gate Resistance	R_g	$f = 1\text{ MHz}$	0.2	0.7	1.4	Ω
Turn-On Delay Time	$t_{d(on)}$	$V_{DD} = 20\text{ V}$, $R_L = 2\text{ }\Omega$ $I_D \cong 10\text{ A}$, $V_{GEN} = 4.5\text{ V}$, $R_g = 1\text{ }\Omega$		19	35	ns
Rise Time	t_r			73	140	
Turn-Off Delay Time	$t_{d(off)}$			32	60	
Fall Time	t_f			12	24	
Turn-On Delay Time	$t_{d(on)}$	$V_{DD} = 20\text{ V}$, $R_L = 2\text{ }\Omega$ $I_D \cong 10\text{ A}$, $V_{GEN} = 10\text{ V}$, $R_g = 1\text{ }\Omega$		9	18	
Rise Time	t_r			10	20	
Turn-Off Delay Time	$t_{d(off)}$			25	45	
Fall Time	t_f			8	16	
Drain-Source Body Diode Characteristics						
Continuous Source-Drain Diode Current	I_S	$T_C = 25\text{ }^\circ\text{C}$			35	A
Pulse Diode Forward Current ^a	I_{SM}				70	
Body Diode Voltage	V_{SD}	$I_S = 4\text{ A}$		0.71	1.1	V
Body Diode Reverse Recovery Time	t_{rr}	$I_F = 10\text{ A}$, $di/dt = 100\text{ A}/\mu\text{s}$, $T_J = 25\text{ }^\circ\text{C}$		24	45	ns
Body Diode Reverse Recovery Charge	Q_{rr}			15	30	nC
Reverse Recovery Fall Time	t_a			13		ns
Reverse Recovery Rise Time	t_b			11		

Notes:

- a. Pulse test; pulse width $\leq 300\text{ }\mu\text{s}$, duty cycle $\leq 2\%$
b. Guaranteed by design, not subject to production testing.

Stresses beyond those listed under "Absolute Maximum Ratings" may cause permanent damage to the device. These are stress ratings only, and functional operation of the device at these or any other conditions beyond those indicated in the operational sections of the specifications is not implied. Exposure to absolute maximum rating conditions for extended periods may affect device reliability.

TYPICAL CHARACTERISTICS 25 °C, unless otherwise noted

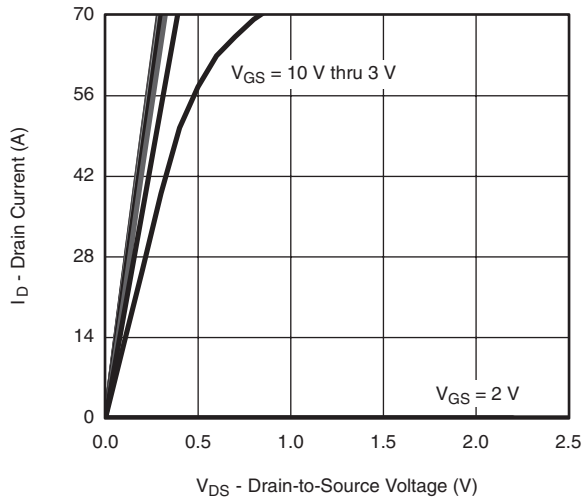

Output Characteristics

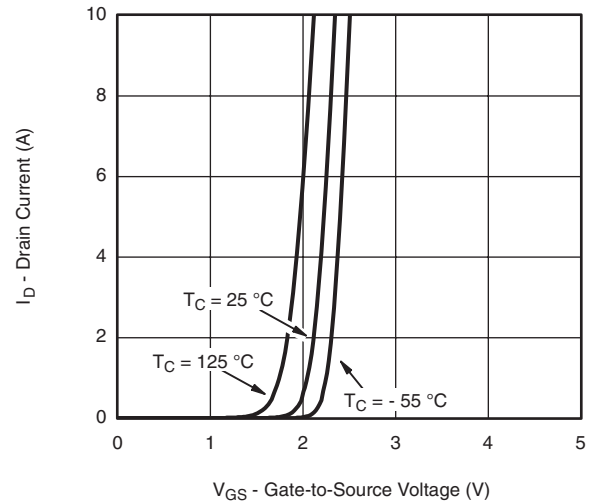

Transfer Characteristics

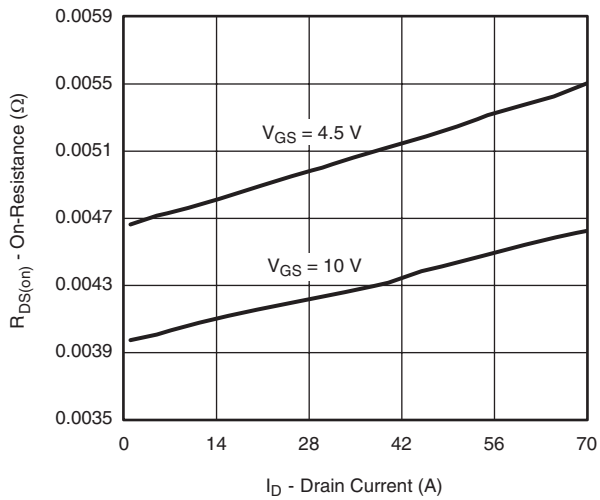

On-Resistance vs. Drain Current and Gate Voltage

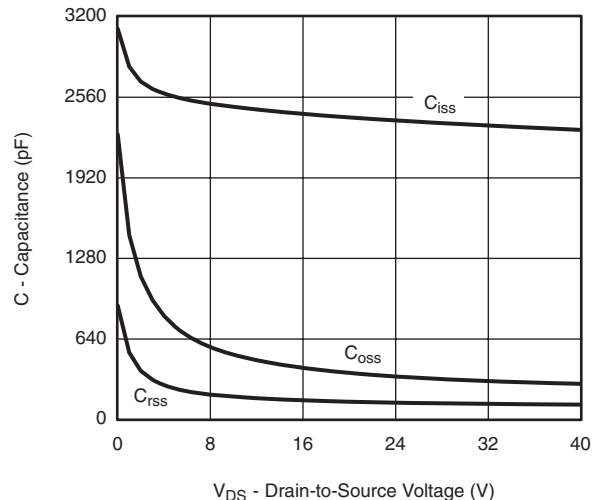

Capacitance

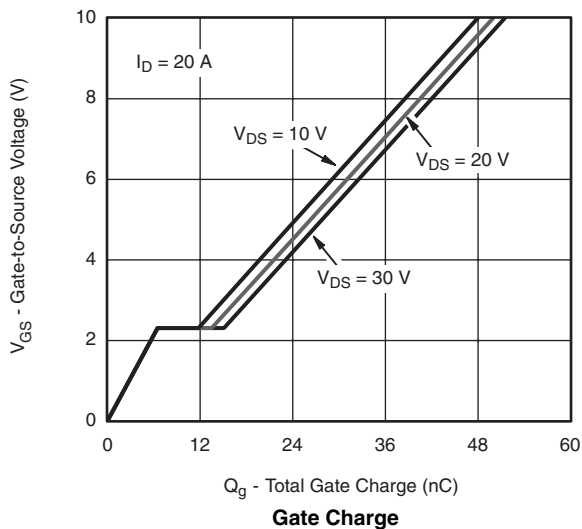

Gate Charge

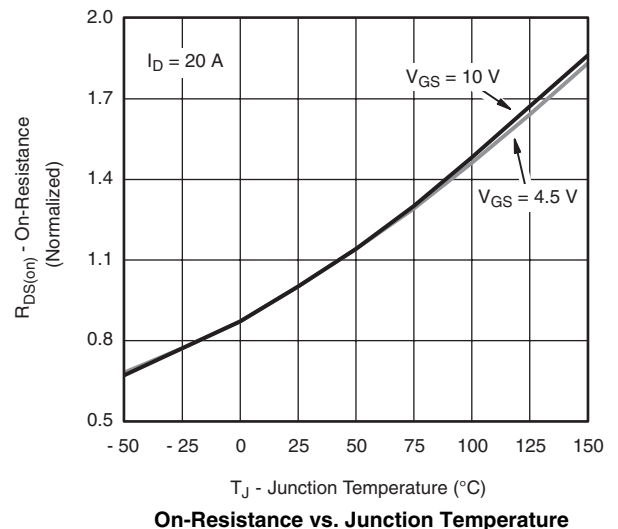

On-Resistance vs. Junction Temperature

TYPICAL CHARACTERISTICS 25 °C, unless otherwise noted

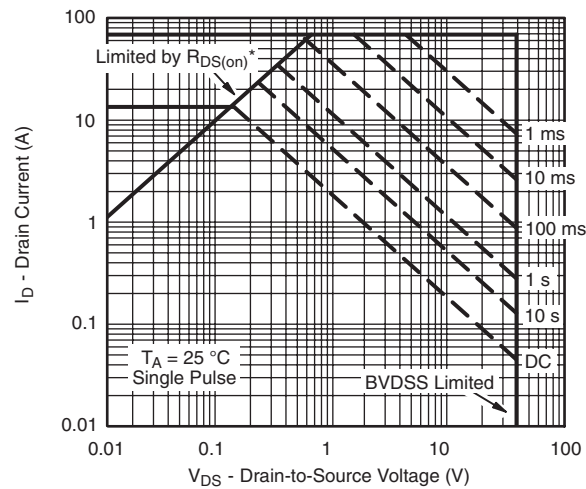
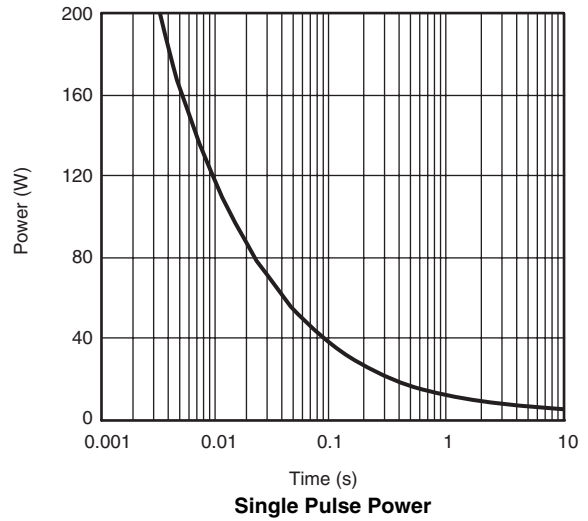
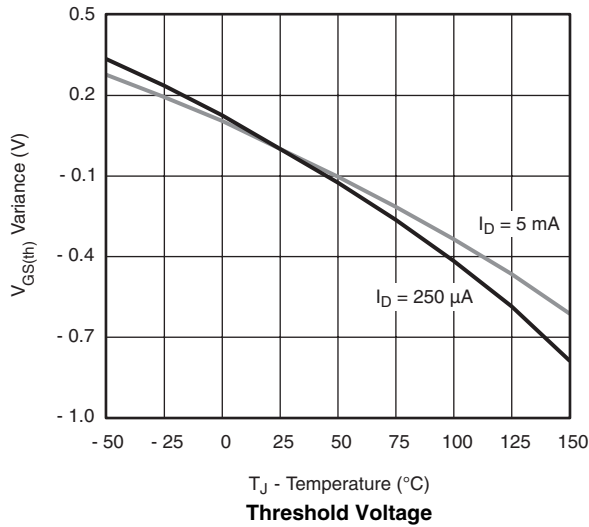
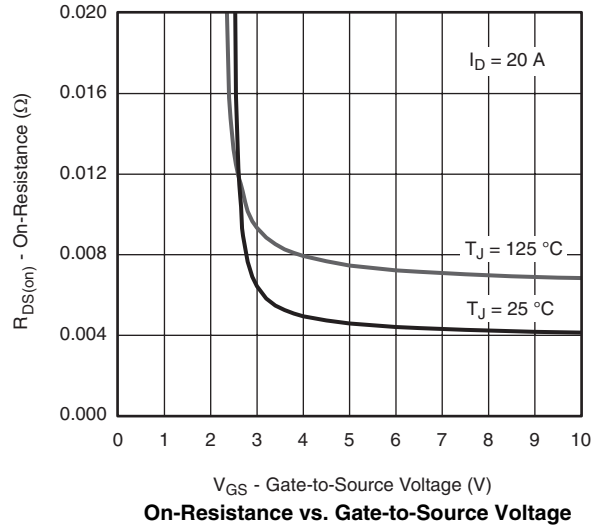
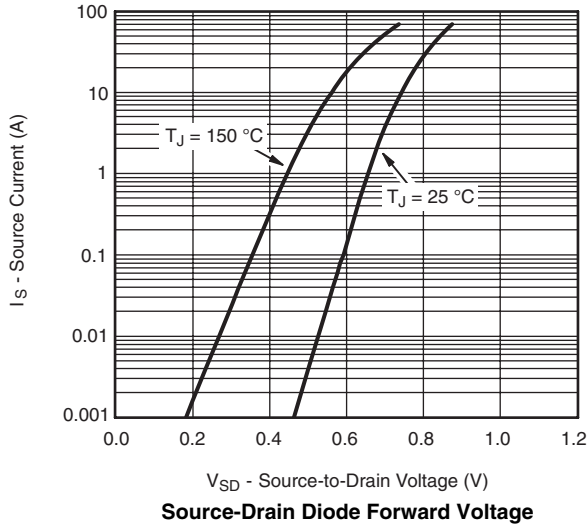

* $V_{GS} >$ minimum V_{GS} at which $R_{DS(on)}$ is specified

TYPICAL CHARACTERISTICS 25 °C, unless otherwise noted

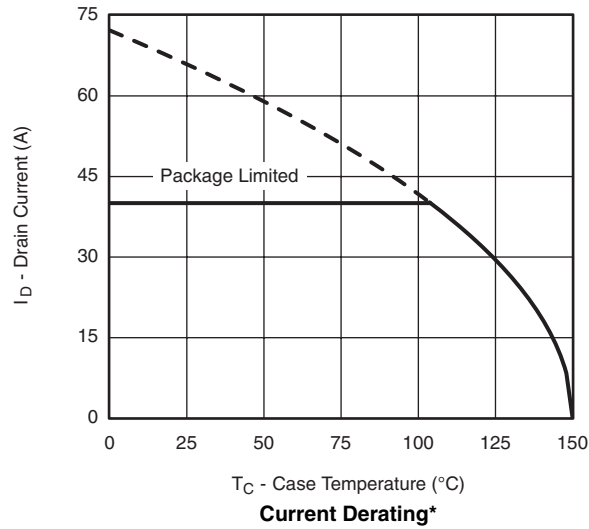

Current Derating*

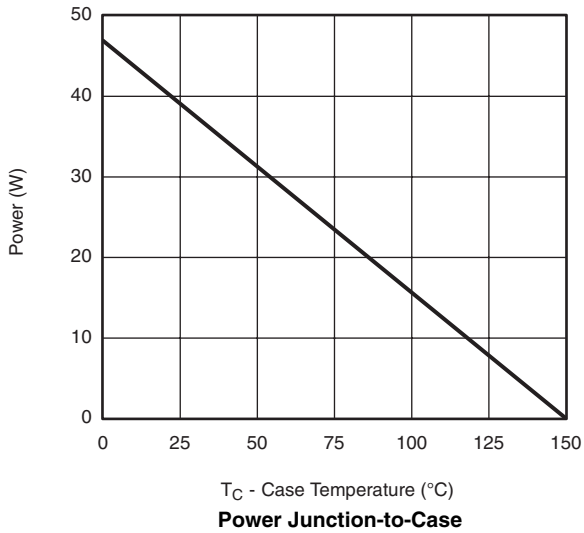

Power Junction-to-Case

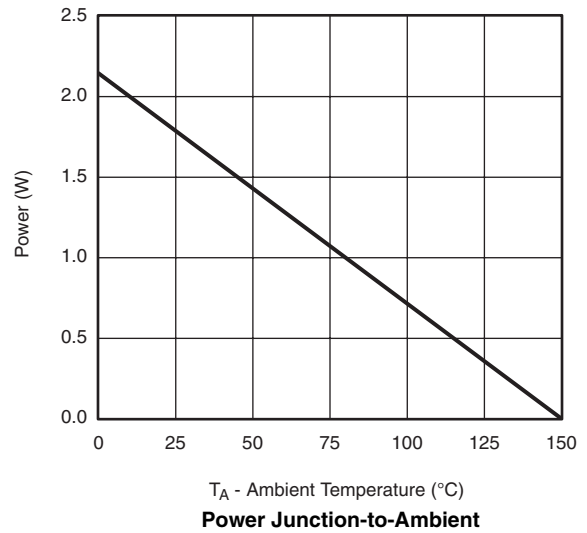

Power Junction-to-Ambient

* The power dissipation P_D is based on $T_{J(max)} = 150$ °C, using junction-to-case thermal resistance, and is more useful in settling the upper dissipation limit for cases where additional heatsinking is used. It is used to determine the current rating, when this rating falls below the package limit.

TYPICAL CHARACTERISTICS 25 °C, unless otherwise noted

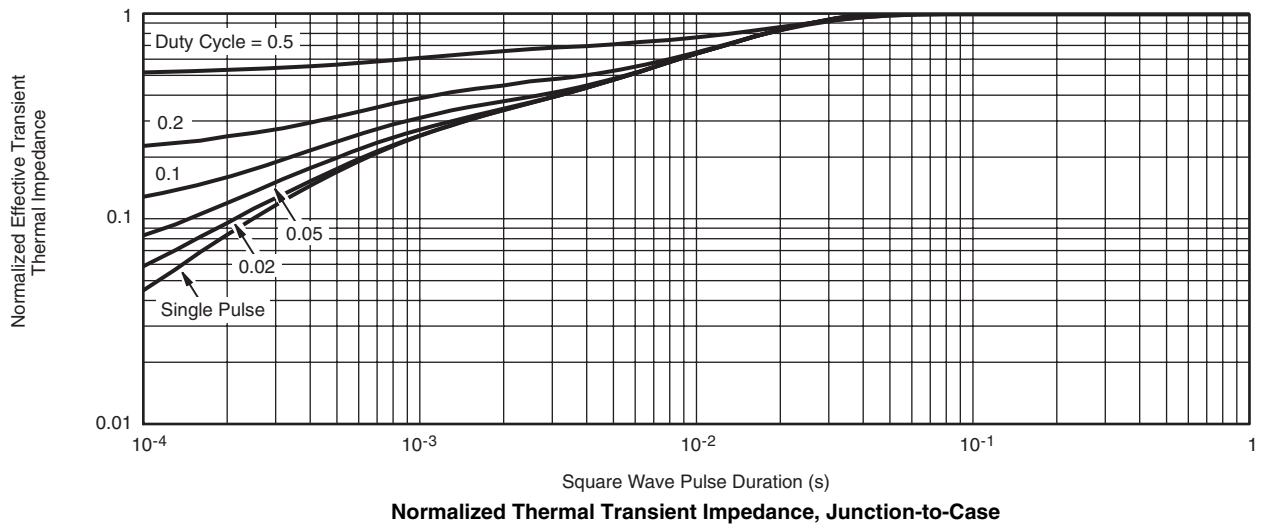
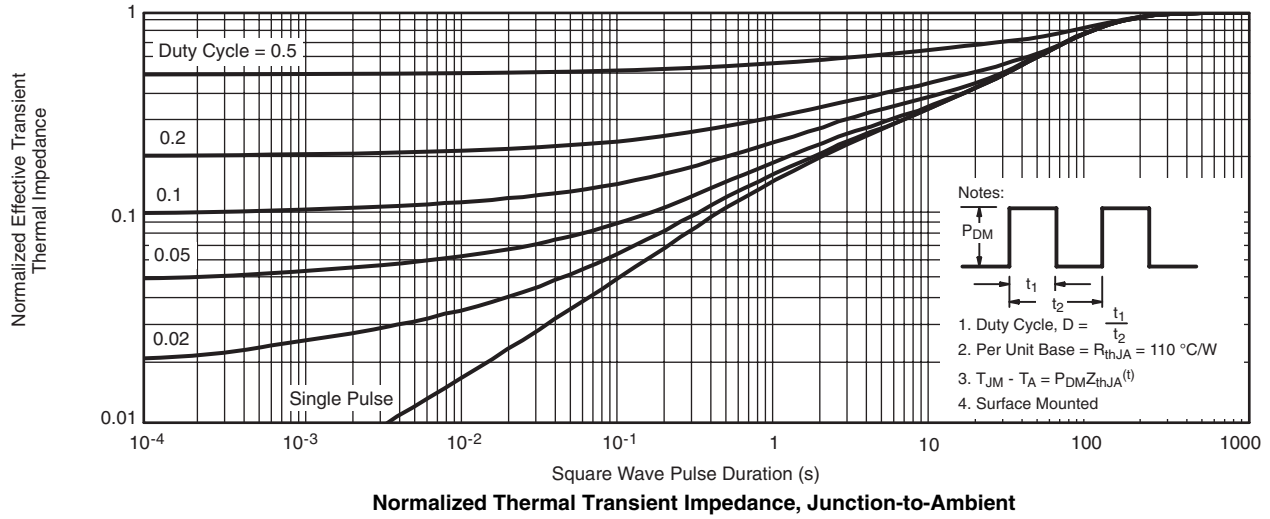

Vishay Siliconix maintains worldwide manufacturing capability. Products may be manufactured at one of several qualified locations. Reliability data for Silicon Technology and Package Reliability represent a composite of all qualified locations. For related documents such as package/tape drawings, part marking, and reliability data, see www.vishay.com/ppg?65153.



Disclaimer

All product specifications and data are subject to change without notice.

Vishay Intertechnology, Inc., its affiliates, agents, and employees, and all persons acting on its or their behalf (collectively, "Vishay"), disclaim any and all liability for any errors, inaccuracies or incompleteness contained herein or in any other disclosure relating to any product.

Vishay disclaims any and all liability arising out of the use or application of any product described herein or of any information provided herein to the maximum extent permitted by law. The product specifications do not expand or otherwise modify Vishay's terms and conditions of purchase, including but not limited to the warranty expressed therein, which apply to these products.

No license, express or implied, by estoppel or otherwise, to any intellectual property rights is granted by this document or by any conduct of Vishay.

The products shown herein are not designed for use in medical, life-saving, or life-sustaining applications unless otherwise expressly indicated. Customers using or selling Vishay products not expressly indicated for use in such applications do so entirely at their own risk and agree to fully indemnify Vishay for any damages arising or resulting from such use or sale. Please contact authorized Vishay personnel to obtain written terms and conditions regarding products designed for such applications.

Product names and markings noted herein may be trademarks of their respective owners.

Mouser Electronics

Authorized Distributor

Click to View Pricing, Inventory, Delivery & Lifecycle Information:

[Vishay:](#)

[SIR418DP-T1-GE3](#)