

Automotive-grade dual N-channel 30 V, 4.5 mΩ typ., 80 A STripFET™ H5 Power MOSFET in a PowerFLAT™ 5x6 package

Datasheet - production data

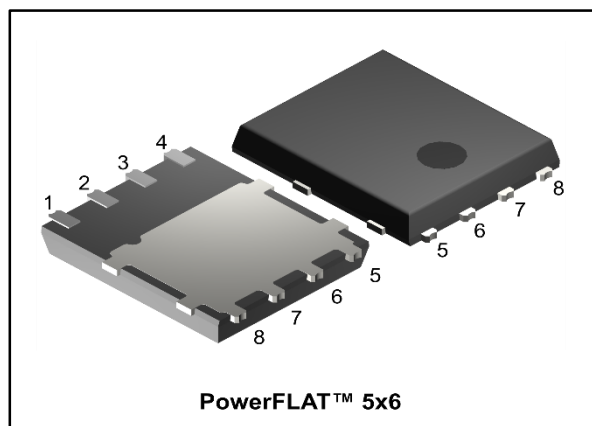
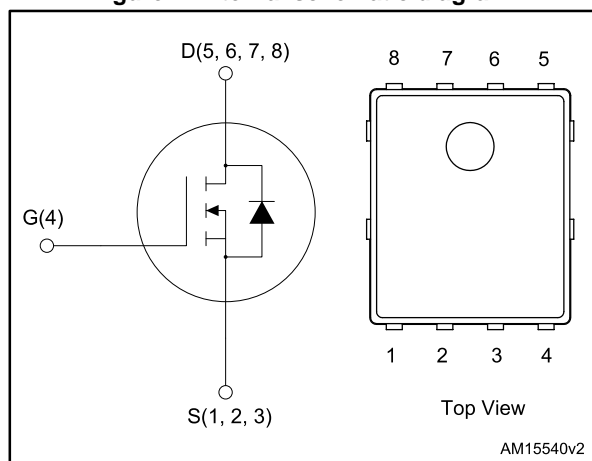

Figure 1: Internal schematic diagram



Features

Order code	V _{DS}	R _{DS(on)} max.	I _D
STL66N3LLH5	30 V	5.8 mΩ	80 A

- Designed for automotive applications and AEC-Q101 qualified
- Low on-resistance R_{DS(on)}
- High avalanche ruggedness
- Low gate drive power loss
- Wettable flank package

Applications

- Switching applications
- Automotive

Description

This device is an N-channel Power MOSFET developed using STMicroelectronics' STripFET™ H5 technology. The device has been optimized to achieve very low on-state resistance, contributing to a FoM that is among the best in its class.

Table 1: Device summary

Order code	Marking	Package	Packing
STL66N3LLH5	66N3LLH5	PowerFLAT™ 5x6	Tape and reel

Contents

1	Electrical ratings	3
2	Electrical characteristics	4
	2.1 Electrical characteristics (curves).....	6
3	Test circuits	9
4	Package information	10
	4.1 PowerFLAT™ 5X6 package information	10
	4.2 PowerFLAT™ 5X6 packing information	12
5	Revision history	14

1 Electrical ratings

Table 2: Absolute maximum ratings

Symbol	Parameter	Value	Unit
V_{DS}	Drain-source voltage	30	V
V_{GS}	Gate-source voltage	± 22	V
$I_D^{(1)}$	Drain current (continuous) at $T_{case} = 25\text{ }^\circ\text{C}$	80	A
	Drain current (continuous) at $T_{case} = 100\text{ }^\circ\text{C}$	57	
$I_D^{(2)}$	Drain current (continuous) at $T_{pcb} = 25\text{ }^\circ\text{C}$	21	A
	Drain current (continuous) at $T_{pcb} = 100\text{ }^\circ\text{C}$	14.5	
$I_{DM}^{(2)(3)}$	Drain current (pulsed)	84	A
$P_{TOT}^{(1)}$	Total dissipation at $T_{case} = 25\text{ }^\circ\text{C}$	72	W
$P_{TOT}^{(2)}$	Total dissipation at $T_{pcb} = 25\text{ }^\circ\text{C}$	4.8	
T_J	Operating junction temperature range	-55 to 175	$^\circ\text{C}$
T_{stg}	Storage temperature range		

Notes:

- (1) This value is rated according to R_{thj-c}
- (2) This value is rated according to $R_{thj-pcb}$
- (3) Pulse width is limited by safe operating area.

Table 3: Thermal data

Symbol	Parameter	Value	Unit
$R_{thj-case}$	Thermal resistance junction-case	2.08	$^\circ\text{C/W}$
$R_{thj-pcb}^{(1)}$	Thermal resistance junction-pcb	31.3	

Notes:

- (1) When mounted on a 1-inch² FR-4, 2 Oz copper board, $t < 10\text{ s}$.

Table 4: Avalanche characteristics

Symbol	Parameter	Value	Unit
I_{AV}	Avalanche current, not repetitive	10.5	A
E_{AS}	Single pulse avalanche energy (starting $T_J = 25\text{ }^\circ\text{C}$, $I_D = I_{AV}$, $V_{DD} = 24\text{ V}$)	180	mJ

2 Electrical characteristics

($T_{\text{case}} = 25\text{ °C}$ unless otherwise specified)

Table 5: Static

Symbol	Parameter	Test conditions	Min.	Typ.	Max.	Unit
$V_{(BR)DSS}$	Drain-source breakdown voltage	$V_{GS} = 0\text{ V}$, $I_D = 250\text{ }\mu\text{A}$	30			V
I_{DSS}	Zero gate voltage drain current	$V_{GS} = 0\text{ V}$, $V_{DS} = 30\text{ V}$			1	μA
		$V_{GS} = 0\text{ V}$, $V_{DS} = 30\text{ V}$, $T_C = 125\text{ °C}$			10	
I_{GSS}	Gate-body leakage current	$V_{DS} = 0\text{ V}$, $V_{GS} = \pm 22\text{ V}$			± 100	nA
$V_{GS(th)}$	Gate threshold voltage	$V_{DS} = V_{GS}$, $I_D = 250\text{ }\mu\text{A}$	1		3	V
$R_{DS(on)}$	Static drain-source on-resistance	$V_{GS} = 10\text{ V}$, $I_D = 10.5\text{ A}$		4.5	5.8	m Ω
		$V_{GS} = 4.5\text{ V}$, $I_D = 10.5\text{ A}$		6	7.5	

Table 6: Dynamic

Symbol	Parameter	Test conditions	Min.	Typ.	Max.	Unit
C_{iss}	Input capacitance	$V_{DS} = 25\text{ V}$, $f = 1\text{ MHz}$, $V_{GS} = 0\text{ V}$	-	1500	-	μF
C_{oss}	Output capacitance		-	295	-	
C_{riss}	Reverse transfer capacitance		-	39	-	
Q_g	Total gate charge	$V_{DD} = 15\text{ V}$, $I_D = 21\text{ A}$, $V_{GS} = 4.5\text{ V}$ (see Figure 14 : "Test circuit for gate charge behavior")	-	12	-	nC
Q_{gs}	Gate-source charge		-	4	-	
Q_{gd}	Gate-drain charge		-	4.7	-	

Table 7: Switching times

Symbol	Parameter	Test conditions	Min.	Typ.	Max.	Unit
$t_{d(on)}$	Turn-on delay time	$V_{DD} = 15\text{ V}$, $I_D = 10.5\text{ A}$ $R_G = 4.7\text{ }\Omega$, $V_{GS} = 10\text{ V}$ (see Figure 13 : "Test circuit for resistive load switching times" and)	-	9.3	-	ns
t_r	Rise time		-	14.5	-	
$t_{d(off)}$	Turn-off delay time		-	22.7	-	
t_f	Fall time		-	4.5	-	

Table 8: Source-drain diode

Symbol	Parameter	Test conditions	Min.	Typ.	Max.	Unit
I_{SD}	Source-drain current		-		21	A
$I_{SDM}^{(1)}$	Source-drain current (pulsed)		-		84	A
$V_{SD}^{(2)}$	Forward on voltage	$V_{GS} = 0\text{ V}$, $I_{SD} = 19\text{ A}$	-		1.1	V
t_{rr}	Reverse recovery time	$I_{SD} = 19\text{ A}$, $di/dt = 100\text{ A}/\mu\text{s}$, $V_{DD} = 25\text{ V}$, $T_j = 150\text{ }^\circ\text{C}$ (see <i>Figure 15: "Test circuit for inductive load switching and diode recovery times")</i>)	-	25		ns
Q_{rr}	Reverse recovery charge		-	17.5		nC
I_{RRM}	Reverse recovery current		-	1.4		A

Notes:

- (1) Pulse width is limited by safe operating area.
(2) Pulse test: pulse duration = 300 μs , duty cycle 1.5%.

2.1 Electrical characteristics (curves)

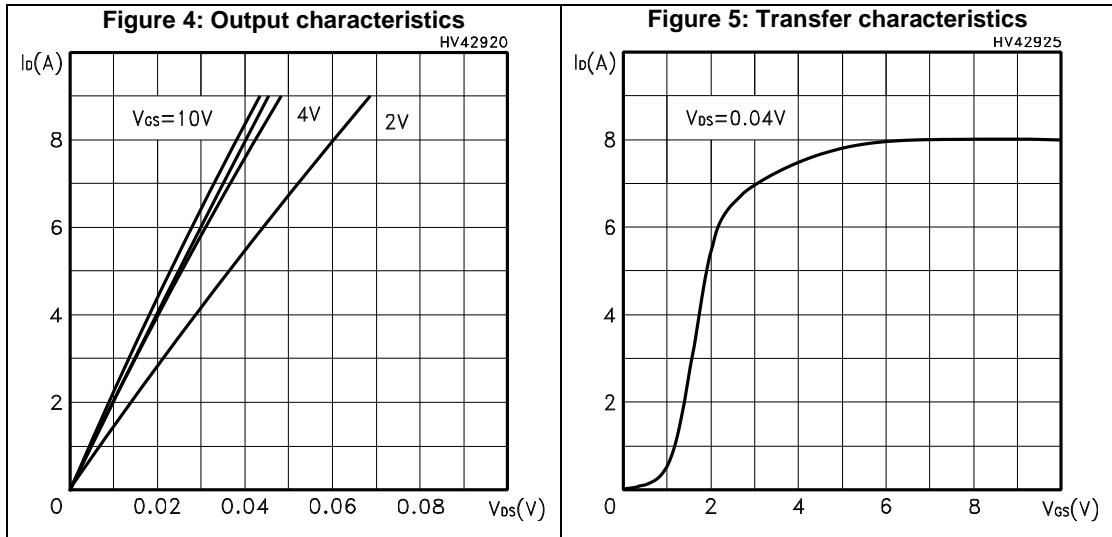
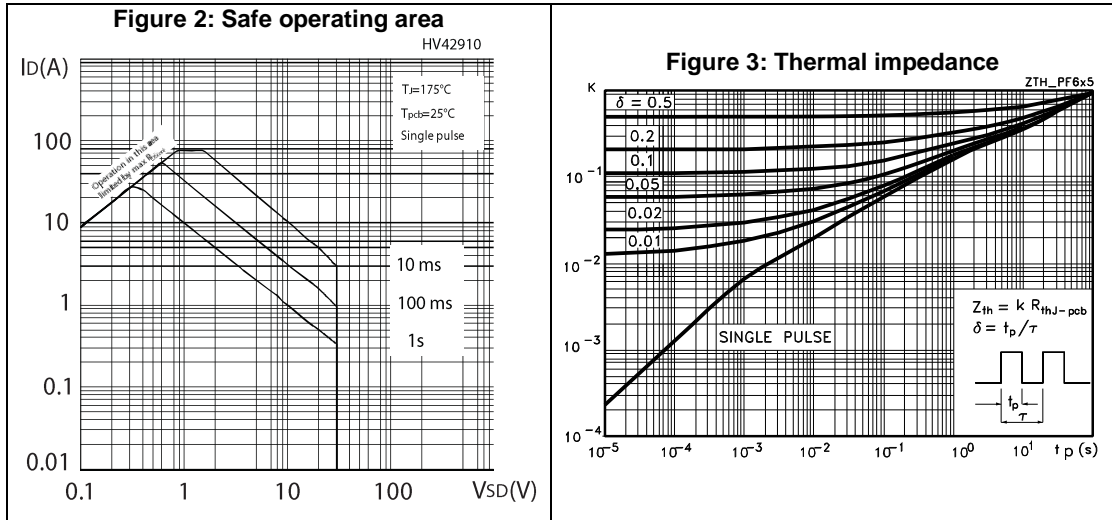

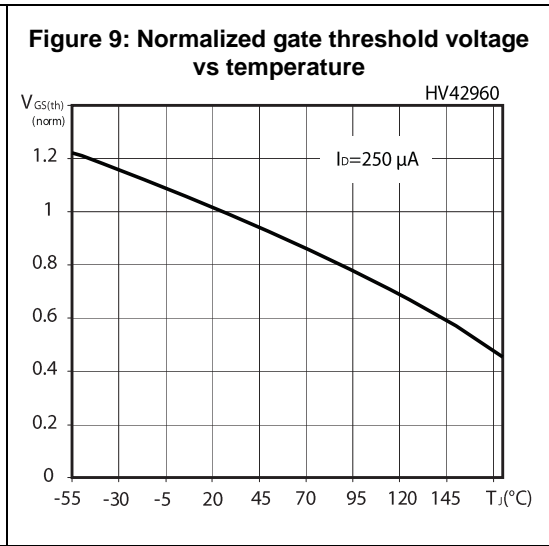
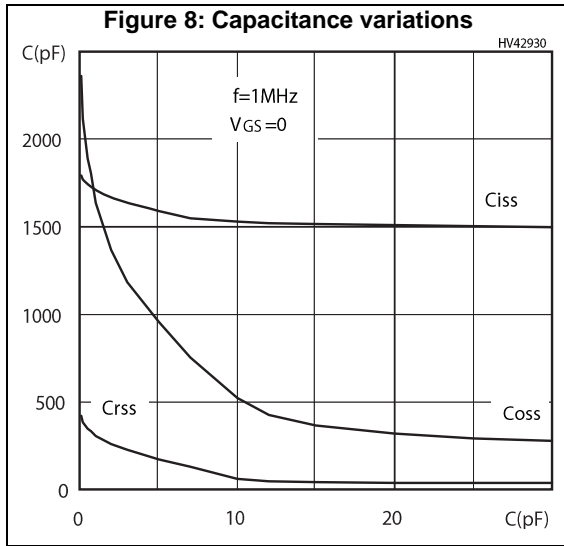
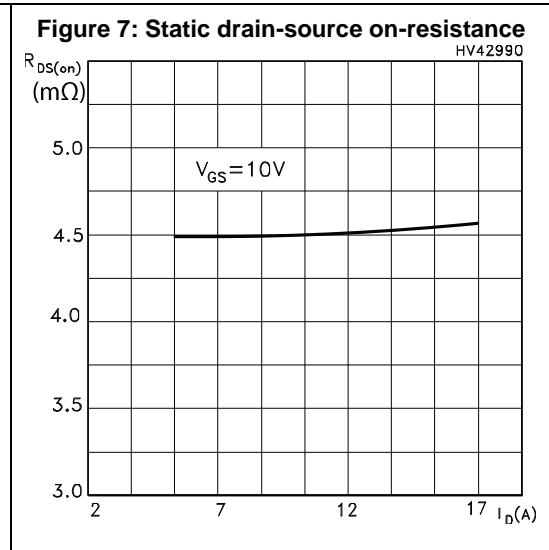
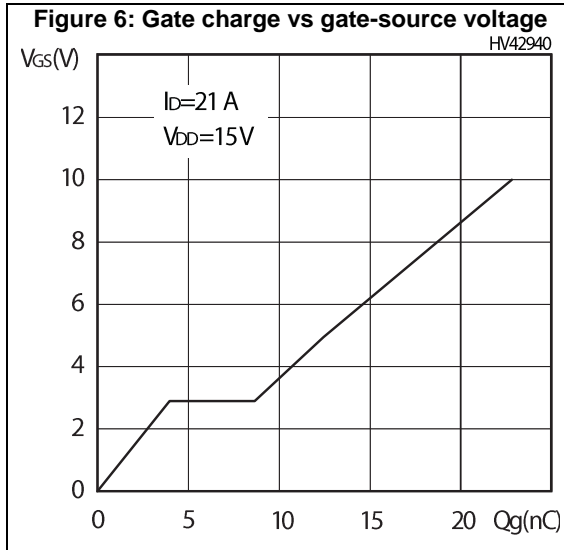

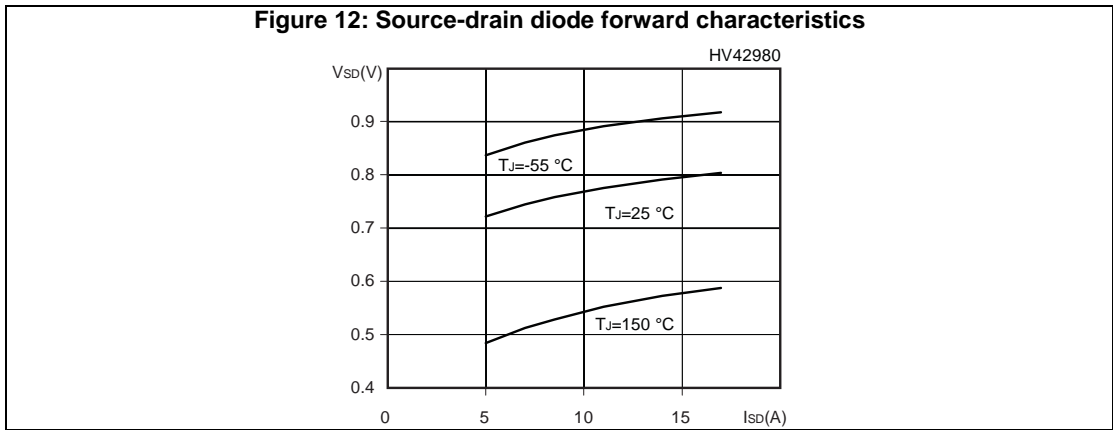
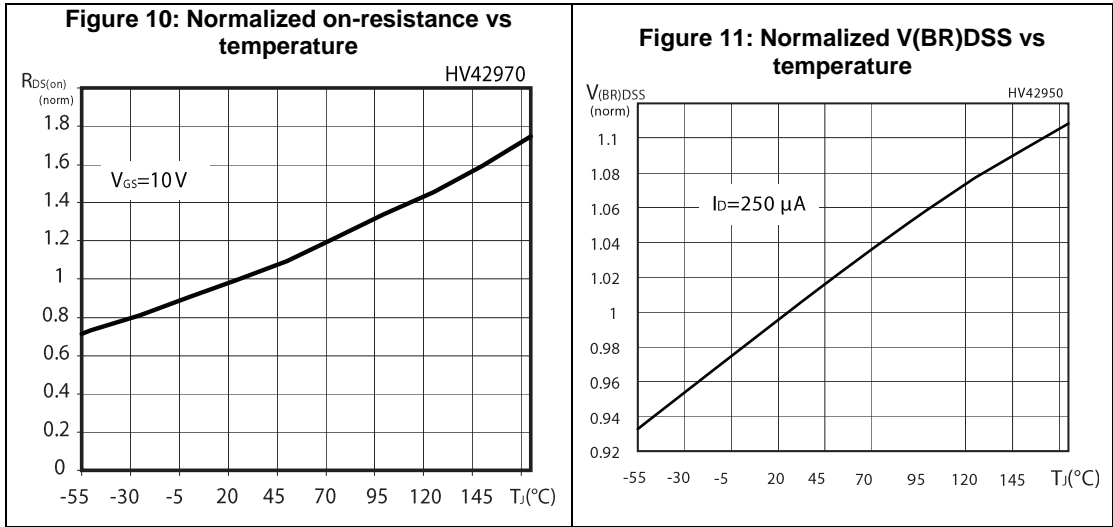

3 Test circuits

Figure 13: Test circuit for resistive load switching times

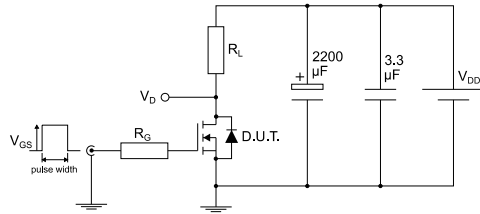

AM01468v1

Figure 14: Test circuit for gate charge behavior



AM01469v1

Figure 15: Test circuit for inductive load switching and diode recovery times

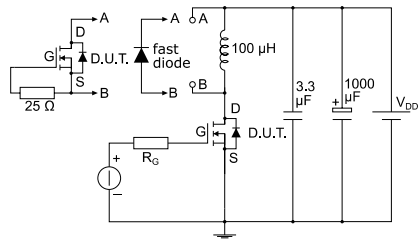

AM01470v1

Figure 16: Unclamped inductive load test circuit

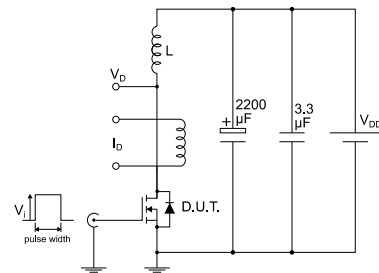

AM01471v1

Figure 17: Unclamped inductive waveform

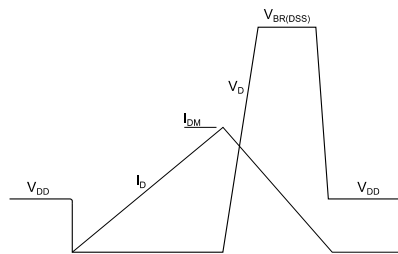

AM01472v1

Figure 18: Switching time waveform

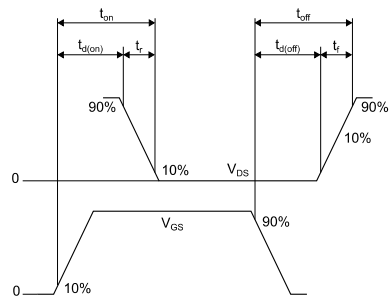

AM01473v1

4 Package information

In order to meet environmental requirements, ST offers these devices in different grades of ECOPACK® packages, depending on their level of environmental compliance. ECOPACK® specifications, grade definitions and product status are available at: www.st.com. ECOPACK® is an ST trademark.

4.1 PowerFLAT™ 5X6 package information

Figure 19: PowerFLAT™ 5x6 WF type C package outline

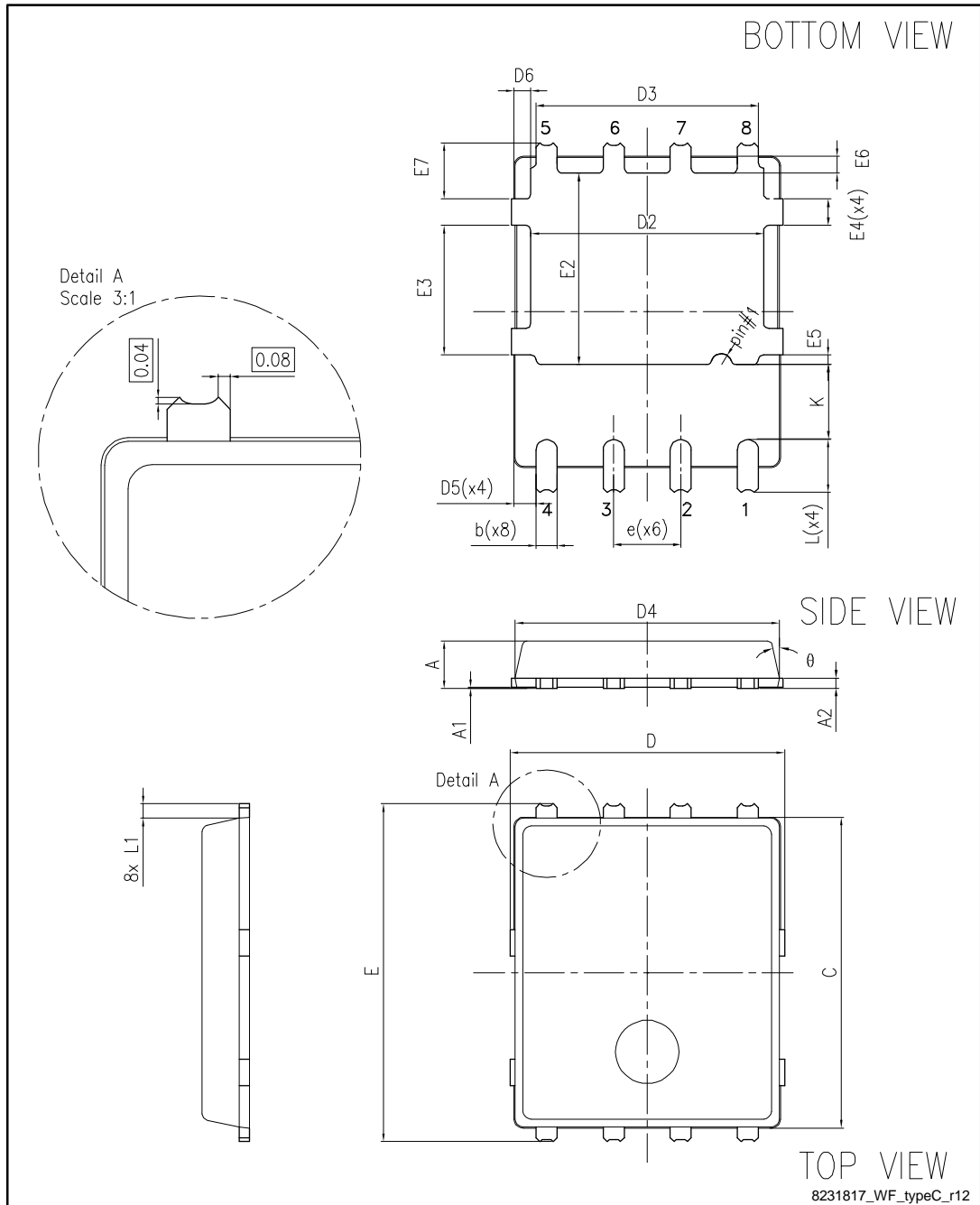
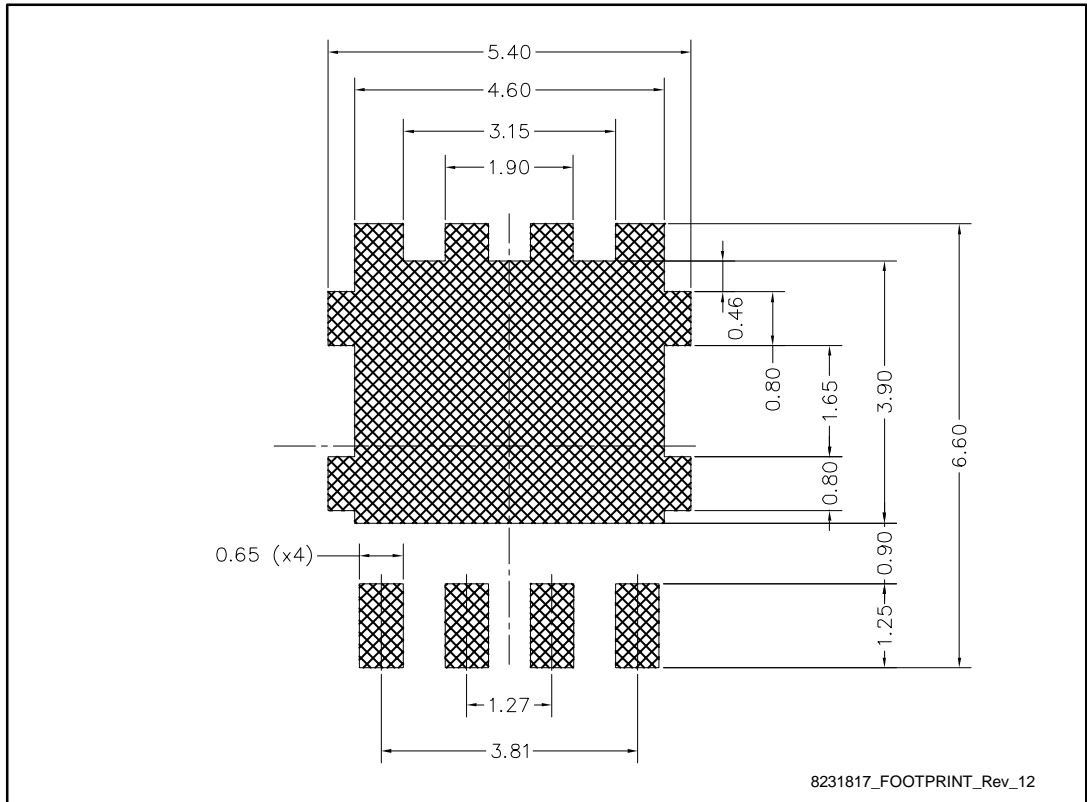

Table 9: PowerFLAT™ 5x6 WF type C mechanical data

Dim.	mm		
	Min.	Typ.	Max.
A	0.80		1.00
A1	0.02		0.05
A2		0.25	
b	0.30		0.50
C	5.80	6.00	6.20
D	5.00	5.20	5.40
D2	4.15		4.45
D3	4.05	4.20	4.35
D4	4.80	5.0	5.20
D5	0.25	0.4	0.55
D6	0.15	0.3	0.45
e		1.27	
E	6.20	6.40	6.60
E2	3.50		3.70
E3	2.35		2.55
E4	0.40		0.60
E5	0.08		0.28
E6	0.2	0.325	0.450
E7	0.85	1.00	1.15
K	1.05		1.35
L	0.90	1.00	1.10
L1	0.175	0.275	0.375
θ	0°		12°

Figure 20: PowerFLAT™ 5x6 recommended footprint (dimensions are in mm)



4.2 PowerFLAT™ 5X6 packing information

Figure 21: PowerFLAT™ 5x6 WF tape

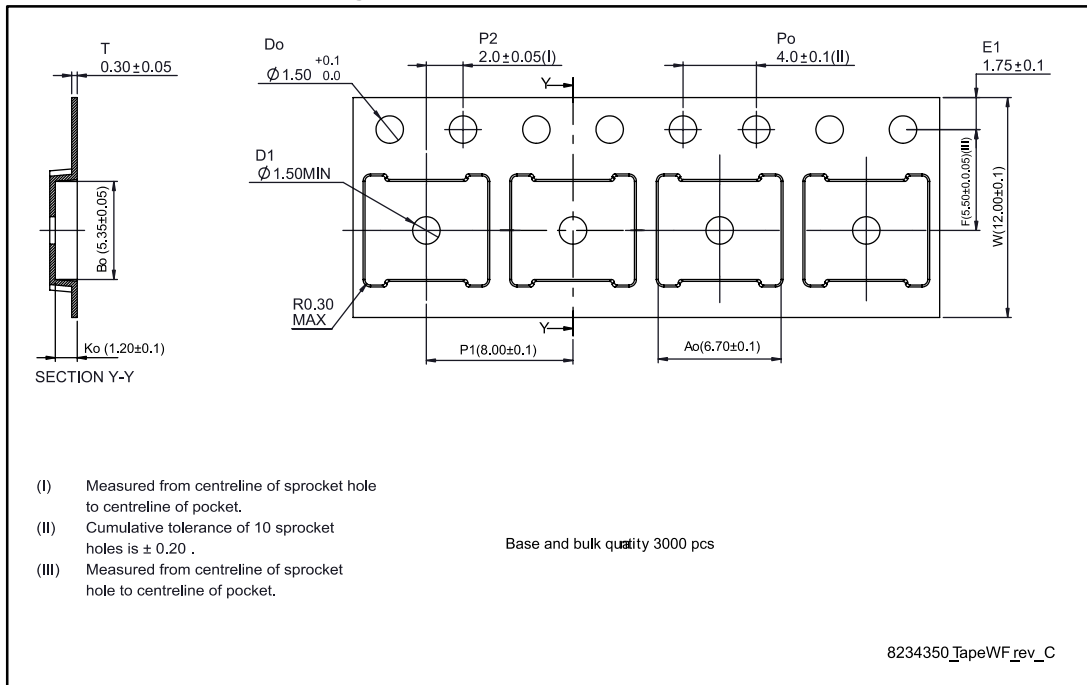

Figure 22: PowerFLAT™ 5x6 package orientation in carrier tape

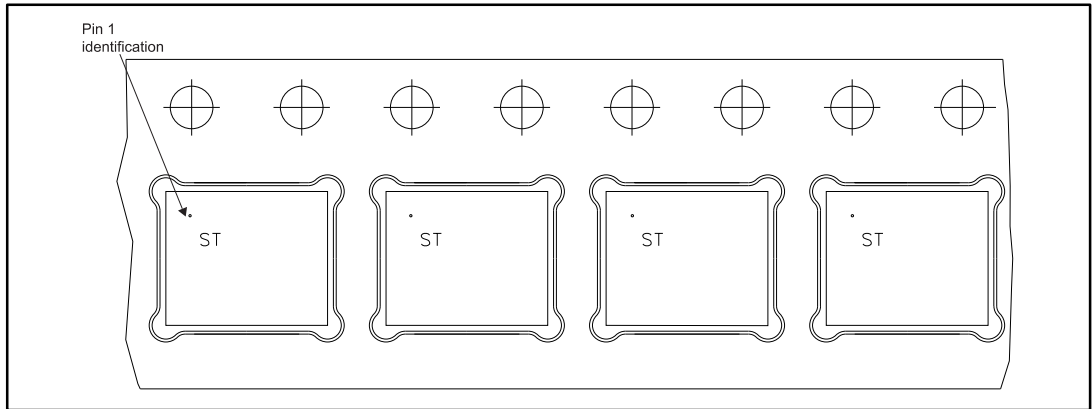
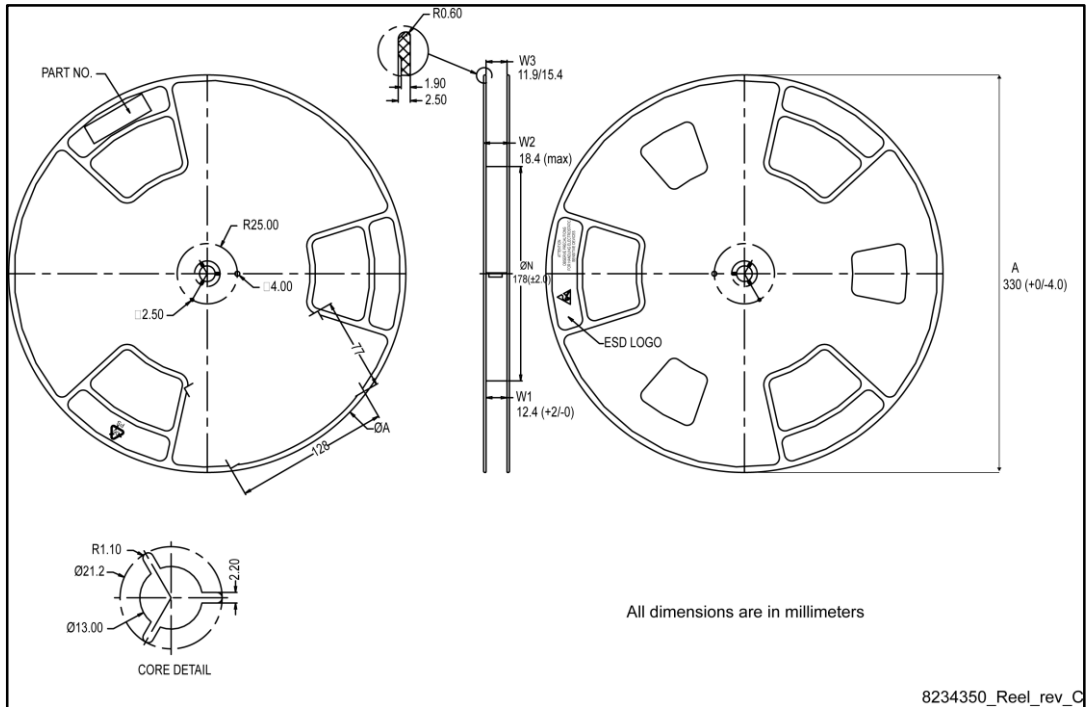

Figure 23: PowerFLAT™ 5x6 reel



5 Revision history

Table 10: Document revision history

Date	Revision	Changes
19-Oct-2011	1	First release.
17-dec-2014	2	Document status promoted from preliminary to production data. Updated title, features and description in cover page. Updated Chapter: Package mechanical data and Chapter: Packaging mechanical data.
22-Jan-2016	3	Updated title and features in cover page. Updated Section 4.1: "PowerFLAT™ 5X6 package information" Minor text changes.

IMPORTANT NOTICE – PLEASE READ CAREFULLY

STMicroelectronics NV and its subsidiaries ("ST") reserve the right to make changes, corrections, enhancements, modifications, and improvements to ST products and/or to this document at any time without notice. Purchasers should obtain the latest relevant information on ST products before placing orders. ST products are sold pursuant to ST's terms and conditions of sale in place at the time of order acknowledgement.

Purchasers are solely responsible for the choice, selection, and use of ST products and ST assumes no liability for application assistance or the design of Purchasers' products.

No license, express or implied, to any intellectual property right is granted by ST herein.

Resale of ST products with provisions different from the information set forth herein shall void any warranty granted by ST for such product.

ST and the ST logo are trademarks of ST. All other product or service names are the property of their respective owners.

Information in this document supersedes and replaces information previously supplied in any prior versions of this document.

© 2016 STMicroelectronics – All rights reserved

Mouser Electronics

Authorized Distributor

Click to View Pricing, Inventory, Delivery & Lifecycle Information:

[STMicroelectronics:](#)

[STL66N3LLH5](#)