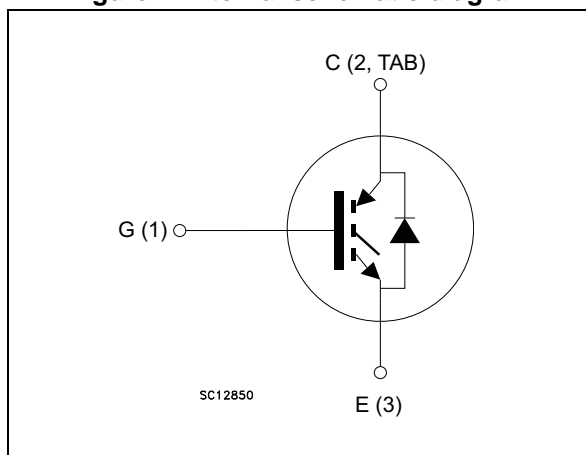

Figure 1. Internal schematic diagram



Features

- High speed switching
- Tight parameters distribution
- Safe paralleling
- Low thermal resistance
- Short-circuit rated
- Ultrafast soft recovery antiparallel diode

Applications

- Motor control
- UPS, PFC

Description

This device is an IGBT developed using an advanced proprietary trench gate and field stop structure. This IGBT series offers the optimum compromise between conduction and switching losses, maximizing the efficiency of very high frequency converters. Furthermore, a positive $V_{CE(sat)}$ temperature coefficient and very tight parameter distribution result in easier paralleling operation.

Table 1. Device summary

Order codes	Marking	Packages	Packaging
STGW20H60DF	GW20H60DF	TO-247	Tube
STGWT20H60DF	GWT20H60DF	TO-3P	Tube

Contents

1	Electrical ratings	3
2	Electrical characteristics	4
	2.1 Electrical characteristics (curves)	7
3	Test circuits	11
4	Package mechanical data	12
5	Revision history	16

1 Electrical ratings

Table 2. Absolute maximum ratings

Symbol	Parameter	Value	Unit
V_{CES}	Collector-emitter voltage ($V_{GE} = 0$)	600	V
I_C	Continuous collector current at $T_C = 25\text{ °C}$	40	A
	Continuous collector current at $T_C = 100\text{ °C}$	20	A
$I_{CP}^{(1)}$	Pulsed collector current	80	A
V_{GE}	Gate-emitter voltage	± 20	V
I_F	Continuous forward current $T_C = 25\text{ °C}$	40	A
	Continuous forward current at $T_C = 100\text{ °C}$	20	
$I_{FP}^{(2)}$	Pulsed forward current	80	A
P_{TOT}	Total dissipation at $T_C = 25\text{ °C}$	167	W
T_{STG}	Storage temperature range	- 55 to 150	°C
T_J	Operating junction temperature	- 55 to 175	

1. Limited by maximum junction temperature.
2. Pulse width limited by maximum junction temperature and turn-off within RBSOA.

Table 3. Thermal data

Symbol	Parameter	Value	Unit
R_{thJC}	Thermal resistance junction-case IGBT	0.9	°C/W
R_{thJC}	Thermal resistance junction-case diode	2.5	°C/W
R_{thJA}	Thermal resistance junction-ambient	62.5	°C/W

2 Electrical characteristics

$T_J = 25\text{ °C}$ unless otherwise specified.

Table 4. Static

Symbol	Parameter	Test conditions	Min.	Typ.	Max.	Unit
$V_{(BR)CES}$	Collector-emitter breakdown voltage ($V_{GE} = 0$)	$I_C = 2\text{ mA}$	600			V
$V_{CE(sat)}$	Collector-emitter saturation voltage	$V_{GE} = 15\text{ V}, I_C = 20\text{ A}$		1.6	2.0	V
		$V_{GE} = 15\text{ V}, I_C = 20\text{ A}$ $T_J = 125\text{ °C}$		1.75		
		$V_{GE} = 15\text{ V}, I_C = 20\text{ A}$ $T_J = 175\text{ °C}$		1.8		
$V_{GE(th)}$	Gate threshold voltage	$V_{CE} = V_{GE}, I_C = 1\text{ mA}$	5	6	7	V
I_{CES}	Collector cut-off current ($V_{GE} = 0$)	$V_{CE} = 600\text{ V}$			25	μA
I_{GES}	Gate-emitter leakage current ($V_{CE} = 0$)	$V_{GE} = \pm 20\text{ V}$			250	nA

Table 5. Dynamic

Symbol	Parameter	Test conditions	Min.	Typ.	Max.	Unit
C_{ies}	Input capacitance	$V_{CE} = 25\text{ V}, f = 1\text{ MHz},$ $V_{GE} = 0$	-	2750	-	pF
C_{oes}	Output capacitance		-	110	-	pF
C_{res}	Reverse transfer capacitance		-	65	-	pF
Q_g	Total gate charge	$V_{CC} = 400\text{ V}, I_C = 20\text{ A},$ $V_{GE} = 15\text{ V}$	-	115	-	nC
Q_{ge}	Gate-emitter charge		-	22	-	nC
Q_{gc}	Gate-collector charge		-	45	-	nC

Table 6. Switching characteristics (inductive load)

Symbol	Parameter	Test conditions	Min.	Typ.	Max.	Unit
$t_{d(on)}$	Turn-on delay time	$V_{CE} = 400\text{ V}$, $I_C = 20\text{ A}$, $R_G = 10\ \Omega$, $V_{GE} = 15\text{ V}$		42.5	-	ns
t_r	Current rise time			11.9	-	ns
$(di/dt)_{on}$	Turn-on current slope			1345	-	A/ μ s
$t_{d(on)}$	Turn-on delay time	$V_{CE} = 400\text{ V}$, $I_C = 20\text{ A}$, $R_G = 10\ \Omega$, $V_{GE} = 15\text{ V}$ $T_J = 175\text{ }^\circ\text{C}$		42.5	-	ns
t_r	Current rise time			13.4		ns
$(di/dt)_{on}$	Turn-on current slope			1180		A/ μ s
$t_{r(Voff)}$	Off voltage rise time	$V_{CE} = 400\text{ V}$, $I_C = 20\text{ A}$, $R_G = 10\ \Omega$, $V_{GE} = 15\text{ V}$		20	-	ns
$t_{d(off)}$	Turn-off delay time			177	-	ns
t_f	Current fall time			55	-	ns
$t_{r(Voff)}$	Off voltage rise time	$V_{CE} = 400\text{ V}$, $I_C = 20\text{ A}$, $R_G = 10\ \Omega$, $V_{GE} = 15\text{ V}$ $T_J = 175\text{ }^\circ\text{C}$		26	-	ns
$t_{d(off)}$	Turn-off delay time			173	-	ns
t_f	Current fall time			86	-	ns
t_{sc}	Short-circuit withstand time	$V_{CC} \leq 360\text{ V}$, $V_{GE} = 15\text{ V}$	3	5	-	μ s

Table 7. Switching energy (inductive load)

Symbol	Parameter	Test conditions	Min.	Typ.	Max.	Unit	
$E_{on}^{(1)}$	Turn-on switching losses	$V_{CE} = 400\text{ V}$, $I_C = 20\text{ A}$, $R_G = 10\ \Omega$, $V_{GE} = 15\text{ V}$	-	209	-	μ J	
$E_{off}^{(2)}$	Turn-off switching losses			-	261	-	μ J
E_{ts}	Total switching losses			-	470	-	μ J
$E_{on}^{(1)}$	Turn-on switching losses	$V_{CE} = 400\text{ V}$, $I_C = 20\text{ A}$, $R_G = 10\ \Omega$, $V_{GE} = 15\text{ V}$ $T_J = 175\text{ }^\circ\text{C}$	-	480	-	μ J	
$E_{off}^{(2)}$	Turn-off switching losses			-	416	-	μ J
E_{ts}	Total switching losses			-	896	-	μ J

1. Energy losses include reverse recovery of the diode.
2. Turn-off losses include also the tail of the collector current.

Table 8. Collector-emitter diode

Symbol	Parameter	Test conditions	Min.	Typ.	Max.	Unit		
V_F	Forward on-voltage	$I_F = 20\text{ A}$ $I_F = 20\text{ A}, T_J = 175\text{ °C}$	-	1.8	2.2	V		
				1.3		V		
t_{rr}	Reverse recovery time	$V_r = 60\text{ V}; I_F = 20\text{ A};$ $di_F/dt = 100\text{ A} / \mu\text{s}$	-	90	-	ns		
Q_{rr}	Reverse recovery charge			110		nC		
I_{rrm}	Reverse recovery current			2.4		A		
t_{rr}	Reverse recovery time	$V_r = 60\text{ V}; I_F = 20\text{ A};$ $di_F/dt = 100\text{ A} / \mu\text{s}$ $T_J = 175\text{ °C}$	-	180	-	ns		
			Q_{rr}	Reverse recovery charge	-	466	-	nC
			I_{rrm}	Reverse recovery current	-	5.2	-	A

2.1 Electrical characteristics (curves)

Figure 2. Output characteristics ($T_J = 25^\circ\text{C}$)

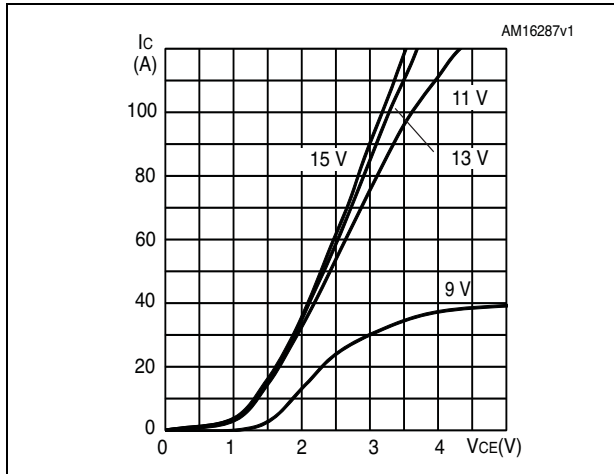

Figure 3. Output characteristics ($T_J = 175^\circ\text{C}$)

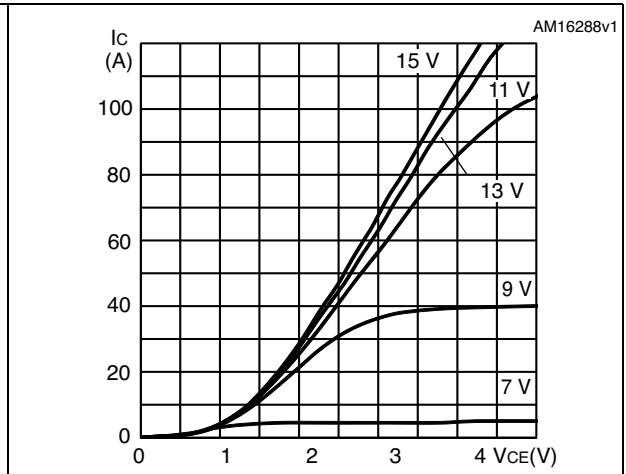

Figure 4. Transfer characteristics

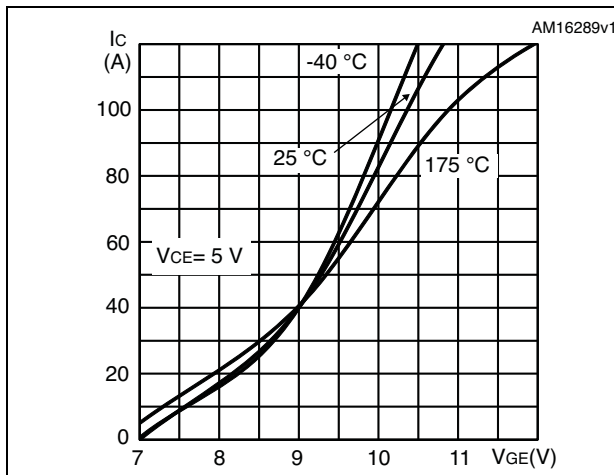

Figure 5. Normalized $V_{GE(th)}$ vs junction temperature

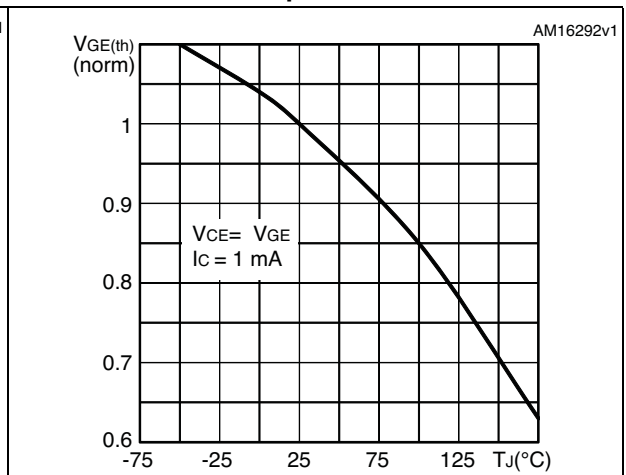

Figure 6. Collector current vs. case temperature

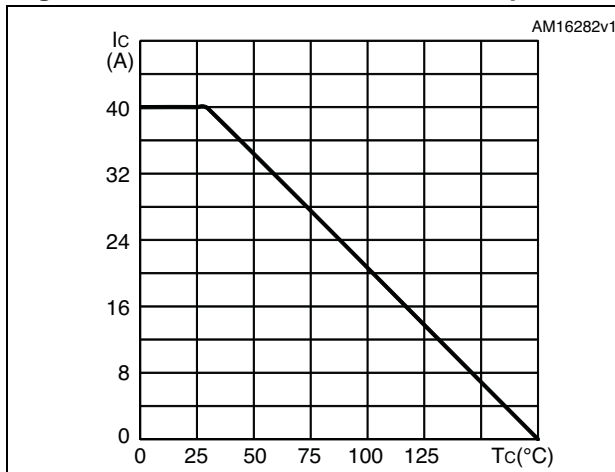

Figure 7. Collector current vs. frequency

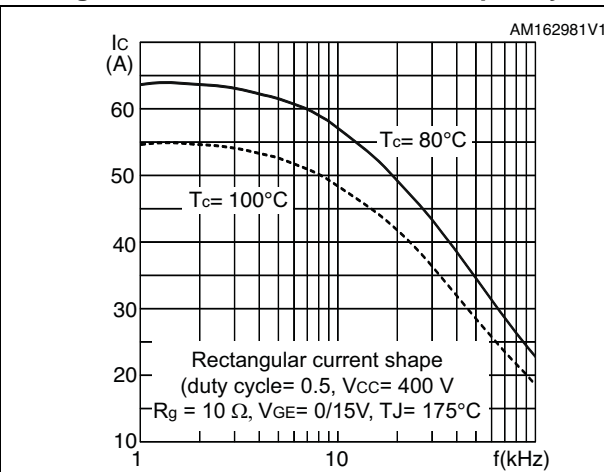

Figure 8. $V_{CE(sat)}$ vs. junction temperature

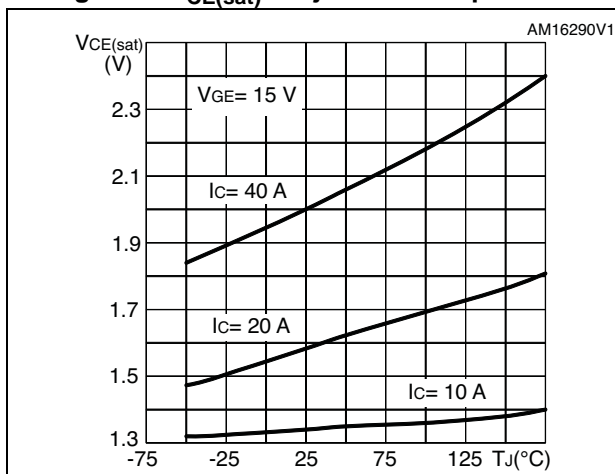

Figure 9. $V_{CE(sat)}$ vs. collector current

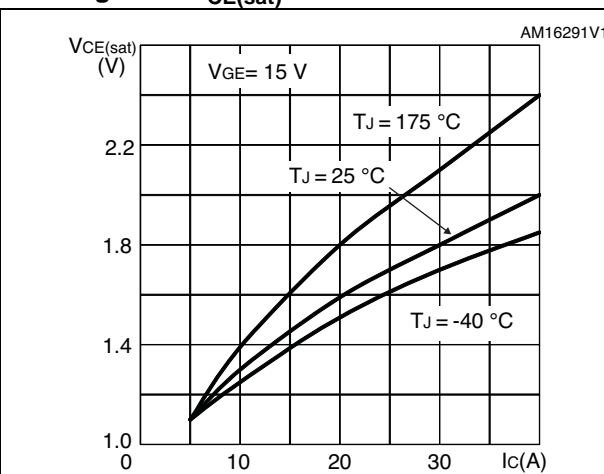

Figure 10. Forward bias safe operating area

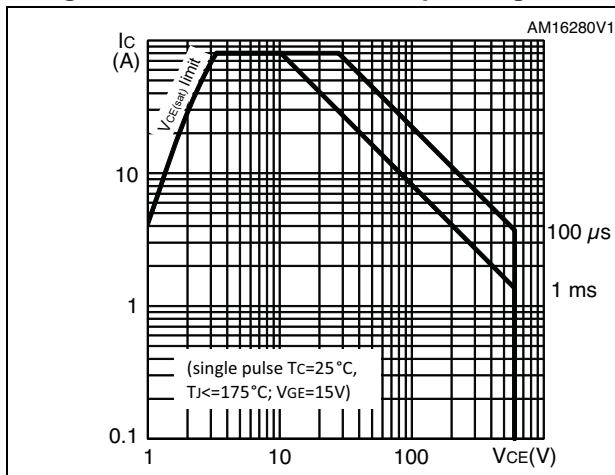

Figure 11. Thermal impedance

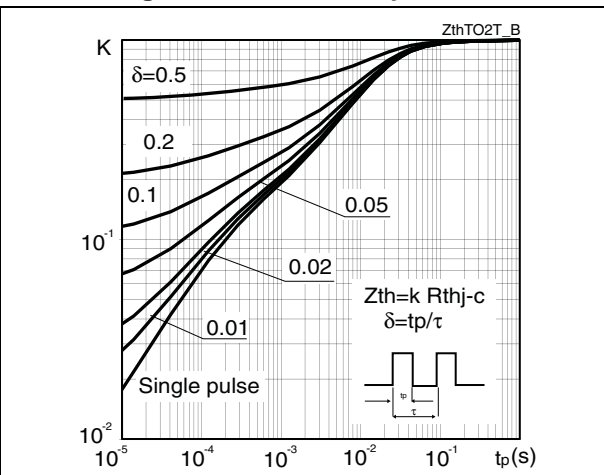

Figure 12. Diode V_F vs. forward current

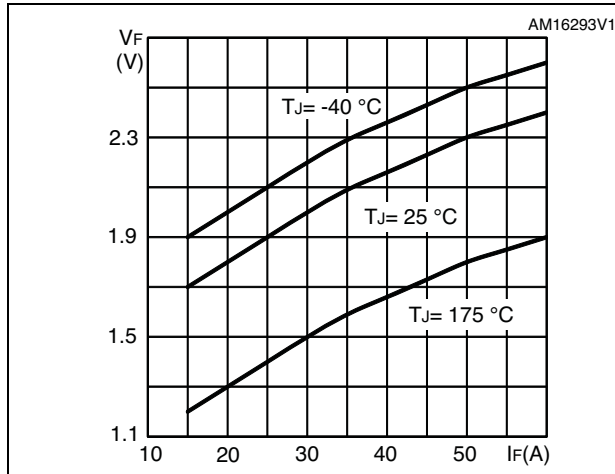

Figure 13. Gate charge vs. gate-emitter voltage

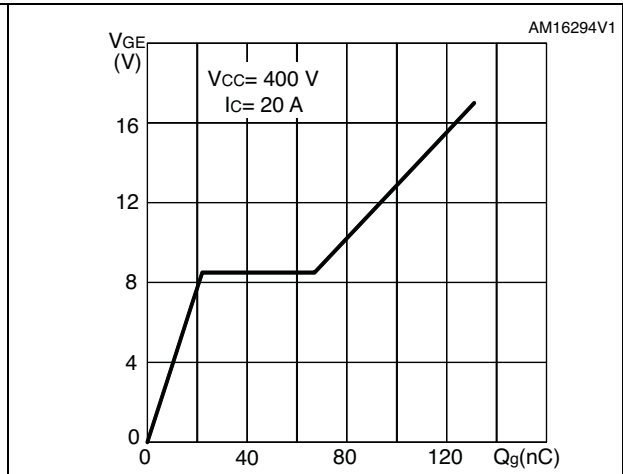

Figure 14. Capacitance variations vs. V_{CE}

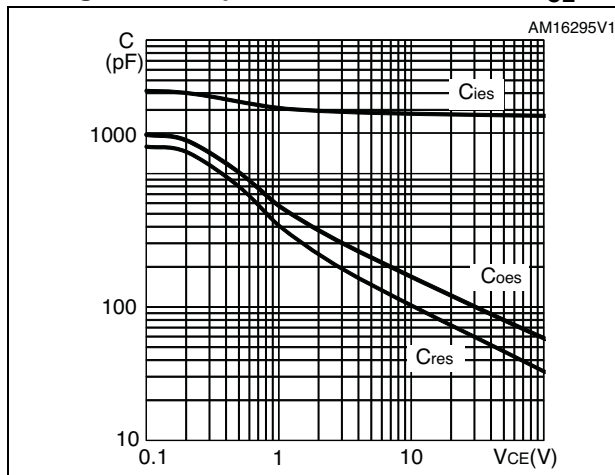

Figure 15. Switching losses vs. gate resistance

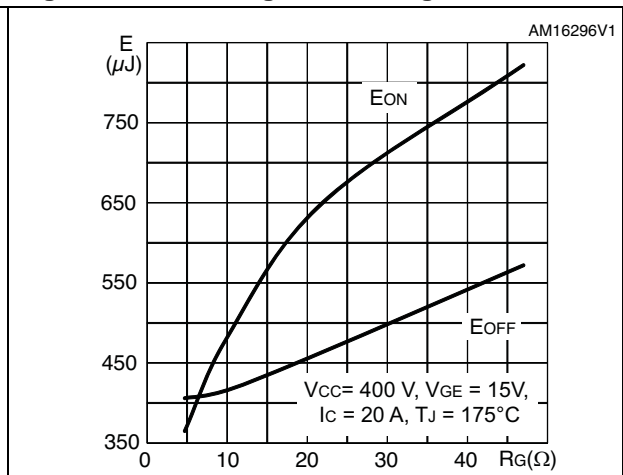

Figure 16. Switching losses vs. collector current

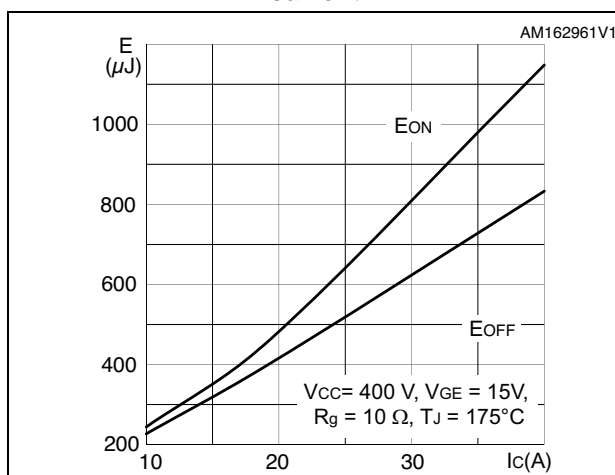

Figure 17. Switching losses vs. temperature

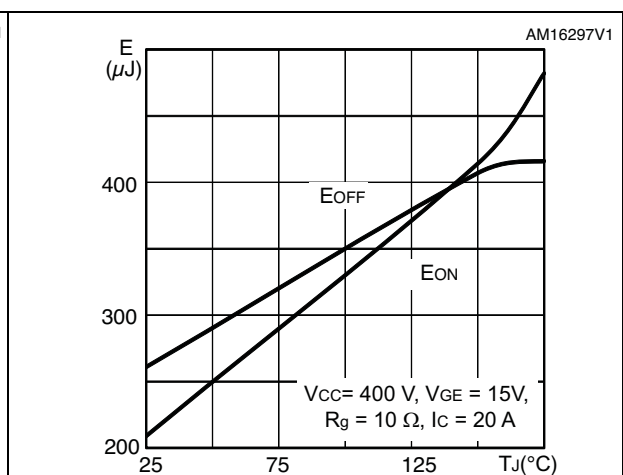

Figure 18. Short-circuit time and current vs. V_{GE}

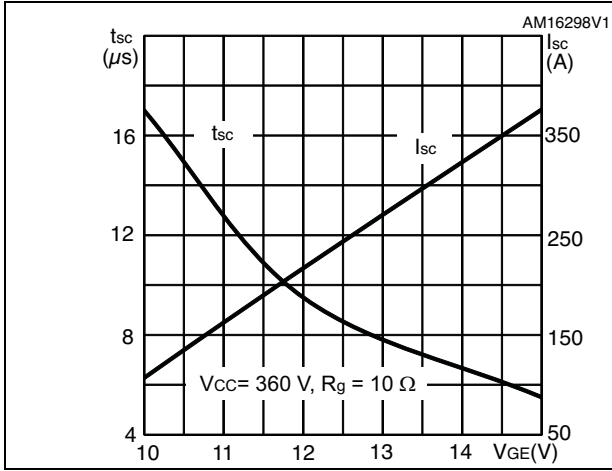
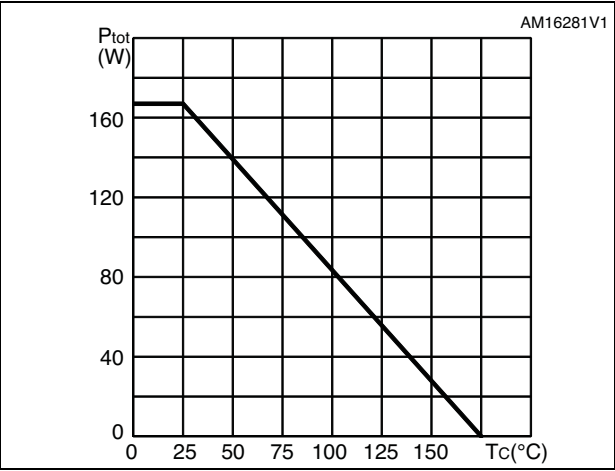

Figure 19. Power dissipation vs. case temperature



3 Test circuits

Figure 20. Test circuit for inductive load switching



Figure 21. Gate charge test circuit

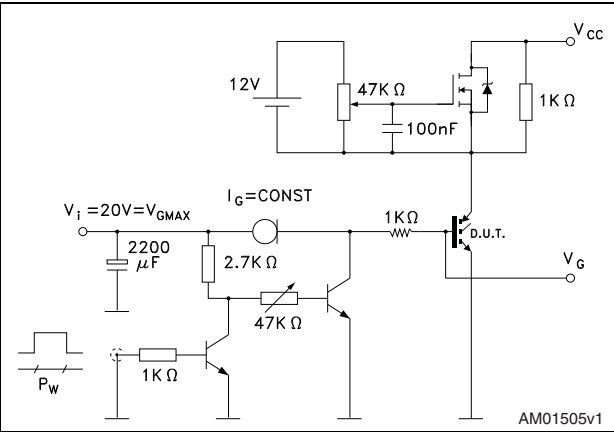

Figure 22. Switching waveform

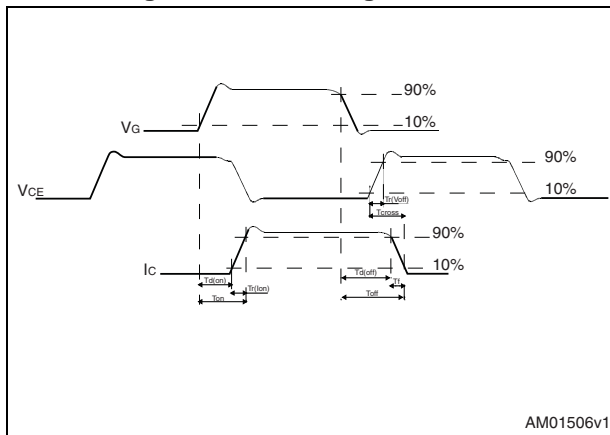
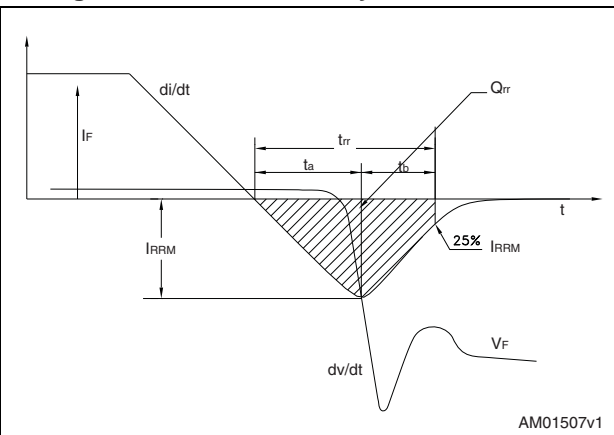

Figure 23. Diode recovery time waveform



4 Package mechanical data

In order to meet environmental requirements, ST offers these devices in different grades of ECOPACK® packages, depending on their level of environmental compliance. ECOPACK® specifications, grade definitions and product status are available at: www.st.com. ECOPACK is an ST trademark.

Table 9. TO-247 mechanical data

Dim.	mm.		
	Min.	Typ.	Max.
A	4.85		5.15
A1	2.20		2.60
b	1.0		1.40
b1	2.0		2.40
b2	3.0		3.40
c	0.40		0.80
D	19.85		20.15
E	15.45		15.75
e	5.30	5.45	5.60
L	14.20		14.80
L1	3.70		4.30
L2		18.50	
ØP	3.55		3.65
ØR	4.50		5.50
S	5.30	5.50	5.70

Figure 24. TO-247 drawing

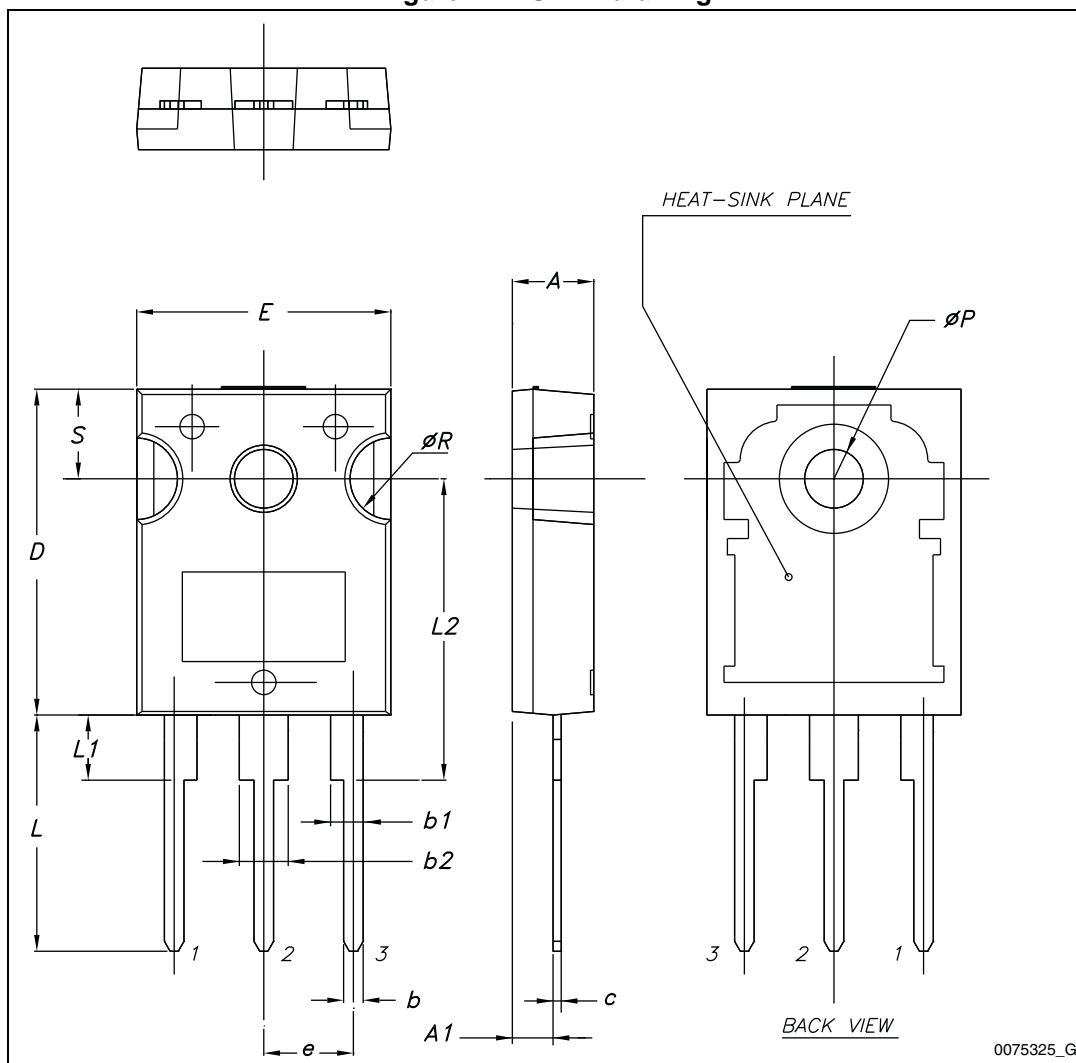

0075325_G

Table 10. TO-3P mechanical data

Dim.	mm		
	Min.	Typ.	Max.
A	4.60		5
A1	1.45	1.50	1.65
A2	1.20	1.40	1.60
b	0.80	1	1.20
b1	1.80		2.20
b2	2.80		3.20
c	0.55	0.60	0.75
D	19.70	19.90	20.10
D1		13.90	
E	15.40		15.80
E1		13.60	
E2		9.60	
e	5.15	5.45	5.75
L	19.50	20	20.50
L1		3.50	
L2	18.20	18.40	18.60
øP	3.10		3.30
Q		5	
Q1		3.80	

Figure 25. TO-3P drawing

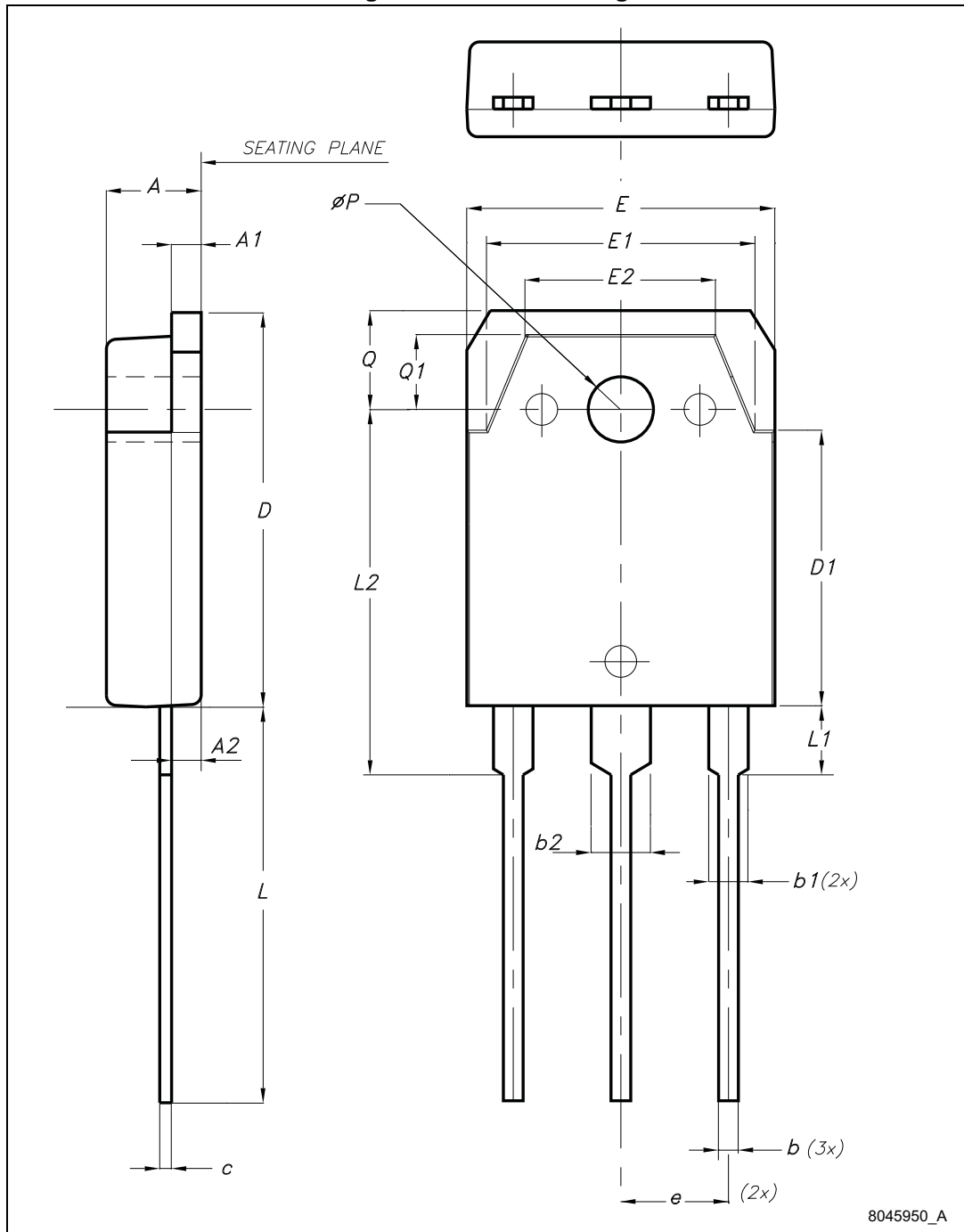

5 Revision history

Table 11. Document revision history

Date	Revision	Changes
06-Jun-2013	1	Initial release.

Please Read Carefully:

Information in this document is provided solely in connection with ST products. STMicroelectronics NV and its subsidiaries ("ST") reserve the right to make changes, corrections, modifications or improvements, to this document, and the products and services described herein at any time, without notice.

All ST products are sold pursuant to ST's terms and conditions of sale.

Purchasers are solely responsible for the choice, selection and use of the ST products and services described herein, and ST assumes no liability whatsoever relating to the choice, selection or use of the ST products and services described herein.

No license, express or implied, by estoppel or otherwise, to any intellectual property rights is granted under this document. If any part of this document refers to any third party products or services it shall not be deemed a license grant by ST for the use of such third party products or services, or any intellectual property contained therein or considered as a warranty covering the use in any manner whatsoever of such third party products or services or any intellectual property contained therein.

UNLESS OTHERWISE SET FORTH IN ST'S TERMS AND CONDITIONS OF SALE ST DISCLAIMS ANY EXPRESS OR IMPLIED WARRANTY WITH RESPECT TO THE USE AND/OR SALE OF ST PRODUCTS INCLUDING WITHOUT LIMITATION IMPLIED WARRANTIES OF MERCHANTABILITY, FITNESS FOR A PARTICULAR PURPOSE (AND THEIR EQUIVALENTS UNDER THE LAWS OF ANY JURISDICTION), OR INFRINGEMENT OF ANY PATENT, COPYRIGHT OR OTHER INTELLECTUAL PROPERTY RIGHT.

ST PRODUCTS ARE NOT AUTHORIZED FOR USE IN WEAPONS. NOR ARE ST PRODUCTS DESIGNED OR AUTHORIZED FOR USE IN: (A) SAFETY CRITICAL APPLICATIONS SUCH AS LIFE SUPPORTING, ACTIVE IMPLANTED DEVICES OR SYSTEMS WITH PRODUCT FUNCTIONAL SAFETY REQUIREMENTS; (B) AERONAUTIC APPLICATIONS; (C) AUTOMOTIVE APPLICATIONS OR ENVIRONMENTS, AND/OR (D) AEROSPACE APPLICATIONS OR ENVIRONMENTS. WHERE ST PRODUCTS ARE NOT DESIGNED FOR SUCH USE, THE PURCHASER SHALL USE PRODUCTS AT PURCHASER'S SOLE RISK, EVEN IF ST HAS BEEN INFORMED IN WRITING OF SUCH USAGE, UNLESS A PRODUCT IS EXPRESSLY DESIGNATED BY ST AS BEING INTENDED FOR "AUTOMOTIVE, AUTOMOTIVE SAFETY OR MEDICAL" INDUSTRY DOMAINS ACCORDING TO ST PRODUCT DESIGN SPECIFICATIONS. PRODUCTS FORMALLY ESCC, QML OR JAN QUALIFIED ARE DEEMED SUITABLE FOR USE IN AEROSPACE BY THE CORRESPONDING GOVERNMENTAL AGENCY.

Resale of ST products with provisions different from the statements and/or technical features set forth in this document shall immediately void any warranty granted by ST for the ST product or service described herein and shall not create or extend in any manner whatsoever, any liability of ST.

ST and the ST logo are trademarks or registered trademarks of ST in various countries.

Information in this document supersedes and replaces all information previously supplied.

The ST logo is a registered trademark of STMicroelectronics. All other names are the property of their respective owners.

© 2013 STMicroelectronics - All rights reserved

STMicroelectronics group of companies

Australia - Belgium - Brazil - Canada - China - Czech Republic - Finland - France - Germany - Hong Kong - India - Israel - Italy - Japan - Malaysia - Malta - Morocco - Philippines - Singapore - Spain - Sweden - Switzerland - United Kingdom - United States of America

www.st.com



Mouser Electronics

Authorized Distributor

Click to View Pricing, Inventory, Delivery & Lifecycle Information:

[STMicroelectronics:](#)

[STGW20H60DF](#) [STGWT20H60DF](#)