

Automotive-grade 10 A, 600 V, short-circuit rugged IGBT with Ultrafast diode

Datasheet - production data

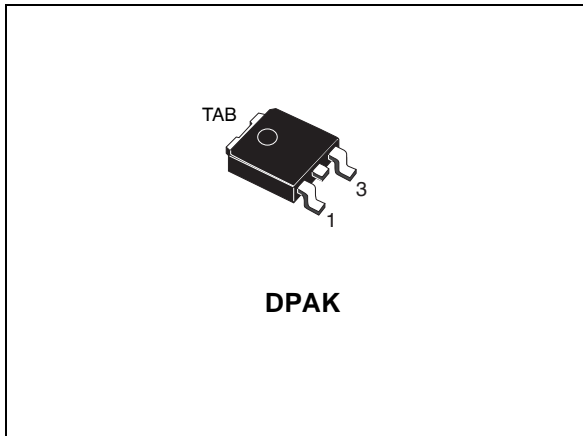

Features

- Designed for automotive applications and AEC-Q101 qualified
- Low on-voltage drop ($V_{CE(sat)}$)
- Low C_{res} / C_{ies} ratio (no cross conduction susceptibility)
- Switching losses include diode recovery energy
- Short-circuit rated
- Very soft Ultrafast recovery anti-parallel diode

Applications

- High frequency inverters
- SMPS and PFC in both hard switch and resonant topologies
- Motor drives
- Injection systems

Description

This device utilizes the advanced PowerMESH™ process for the IGBT and the Turbo 2 Ultrafast high voltage technology for the diode. The combination results in a very good trade-off between conduction losses and switching behavior rendering the product ideal for diverse high voltage applications operating at high frequencies.

Figure 1. Internal schematic diagram

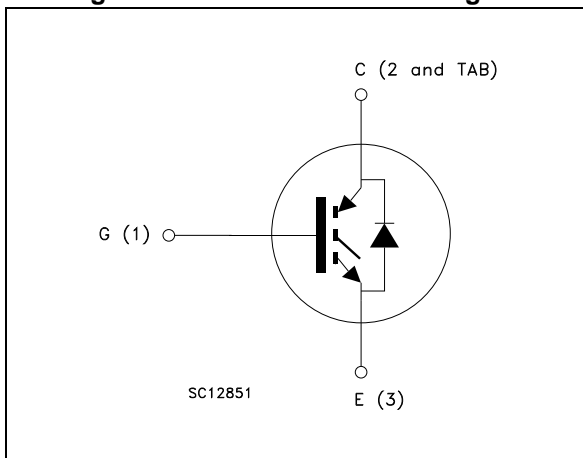

Table 1. Device summary

Order code	Marking	Package	Packaging
STGD10HF60KD	GD10HF60KD	DPAK	Tape and reel

Contents

1	Electrical ratings	3
2	Electrical characteristics	4
	2.1 Electrical characteristics (curves)	7
3	Test circuits	13
4	Package mechanical data	14
5	Packaging mechanical data	18
6	Revision history	20

1 Electrical ratings

$T_{CASE} = 25\text{ °C}$ unless otherwise specified.

Table 2. Absolute maximum ratings

Symbol	Parameter	Value	Unit
V_{CES}	Collector-emitter voltage ($V_{GE} = 0$)	600	V
$I_C^{(1)}$	Collector current (continuous) at $T_C = 25\text{ °C}$	18	A
$I_C^{(1)}$	Collector current (continuous) at $T_C = 100\text{ °C}$	10	A
$I_{CL}^{(2)}$	Turn-off latching current	30	A
$I_{CP}^{(3)}$	Pulsed collector current	30	A
V_{GE}	Gate-emitter voltage	± 20	V
V_{GEM}	Gate-emitter voltage pulsed ($t_p \leq 1\text{ ms}$)	± 30	V
I_F	Diode RMS forward current	7	A
I_{FSM}	Surge non repetitive forward current $t_p = 10\text{ ms}$ sinusoidal	20	A
P_{TOT}	Total dissipation	62.5	W
t_{scw}	Short circuit withstand time ($V_{CE} = 50\text{ V}$, $V_{GE} = 15\text{ V}$, $T_C = 150\text{ °C}$)	10	μs
T_j	IGBT operating junction temperature	- 55 to 150	$^{\circ}C$
	Diode operating junction temperature	- 55 to 175	$^{\circ}C$
T_{stg}	Storage temperature	- 65 to 150	$^{\circ}C$

1. Calculated according to the iterative formula:

$$I_C(T_C) = \frac{T_{j(max)} - T_C}{R_{thj-c} \times V_{CE(sat)(max)}(T_{j(max)}, I_C(T_C))}$$

- $V_{clamp} = 80\%$ of V_{CES} , $T_j = 150\text{ °C}$, $R_G = 10\ \Omega$, $V_{GE} = 15\text{ V}$
- Pulse width limited by max. junction temperature allowed

Table 3. Thermal data

Symbol	Parameter	Value	Unit
$R_{thj-case}$	Thermal resistance junction-case IGBT	2	$^{\circ}C/W$
$R_{thj-case}$	Thermal resistance junction-case diode	5.8	$^{\circ}C/W$
$R_{thj-amb}$	Thermal resistance junction-ambient	100	$^{\circ}C/W$

2 Electrical characteristics

T_{CASE}=25 °C unless otherwise specified.

Table 4. Static

Symbol	Parameter	Test conditions	Min.	Typ.	Max.	Unit
V _{(BR)CES}	Collector-emitter breakdown voltage (V _{GE} = 0)	I _C = 1 mA, T _C = -40 °C ⁽¹⁾		610		V
		I _C = 1 mA	600	650		V
		I _C = 1 mA, T _C = 150 °C		700		V
I _{GES}	Gate-emitter leakage current (V _{CE} = 0)	V _{GE} = ±20 V V _{GE} = ±20 V, T _C = 150 °C			±100 ± 1	nA µA
I _{CES}	Collector cut-off current (V _{GE} = 0)	V _{CE} = 600 V V _{CE} = 600 V, T _C = 150 °C			150 1	µA mA
V _{GE(th)}	Gate threshold voltage	V _{CE} = V _{GE} , I _C = 250 µA	4.5		6.5	V
V _{CE(sat)}	Collector-emitter saturation voltage	V _{GE} = 15 V, I _C = 5 A	1.75		2.75	V

1. Value guaranteed by design

Table 5. Dynamic ⁽¹⁾

Symbol	Parameter	Test conditions	Min.	Typ.	Max.	Unit
C _{ies}	Input capacitance	V _{CE} = 25 V, f = 1 MHz, V _{GE} = 0	-	430	-	pF
C _{oes}	Output capacitance		-	45	-	pF
C _{res}	Reverse transfer capacitance		-	10	-	pF
Q _g	Total gate charge	V _{CE} = 400 V, I _C = 5 A, V _{GE} = 15 V	-	23	-	nC
Q _{ge}	Gate-emitter charge		-	4	-	nC
Q _{gc}	Gate-collector charge		-	11	-	nC

1. Values guaranteed by design

Table 6. Switching on/off (inductive load) ⁽¹⁾

Symbol	Parameter	Test conditions	Min.	Typ.	Max.	Unit
$t_{d(on)}$	Turn-on delay time	$V_{CC} = 400\text{ V}$, $I_C = 5\text{ A}$ $R_G = 10\ \Omega$, $V_{GE} = 15\text{ V}$	-	9.5	-	ns
t_r	Current rise time		-	4.4	-	ns
$(di/dt)_{on}$	Turn-on current slope				930	
$t_{d(on)}$	Turn-on delay time	$V_{CC} = 400\text{ V}$, $I_C = 5\text{ A}$ $R_G = 10\ \Omega$, $V_{GE} = 15\text{ V}$ $T_C = 150\text{ }^\circ\text{C}$	-	11	-	ns
t_r	Current rise time		-	4.8	-	ns
$(di/dt)_{on}$	Turn-on current slope		-	904	-	A/ μ s
$t_{r(Voff)}$	Off voltage rise time	$V_{CC} = 400\text{ V}$, $I_C = 5\text{ A}$, $R_{GE} = 10\ \Omega$, $V_{GE} = 15\text{ V}$	-	34	-	ns
$t_{d(off)}$	Turn-off delay time		-	87	-	ns
t_f	Current fall time		-	100	-	ns
$t_{r(Voff)}$	Off voltage rise time	$V_{CC} = 400\text{ V}$, $I_C = 5\text{ A}$, $R_{GE} = 10\ \Omega$, $V_{GE} = 15\text{ V}$ $T_C = 150\text{ }^\circ\text{C}$	-	83	-	ns
$t_{d(off)}$	Turn-off delay time		-	93	-	ns
t_f	Current fall time		-	224	-	ns

1. Value guaranteed by design

Table 7. Switching energy (inductive load) ⁽¹⁾

Symbol	Parameter	Test conditions	Min	Typ.	Max	Unit
$E_{on}^{(2)}$	Turn-on switching losses	$V_{CC} = 400\text{ V}$, $I_C = 5\text{ A}$ $R_G = 10\ \Omega$, $V_{GE} = 15\text{ V}$	-	45	-	μ J
$E_{off}^{(3)}$	Turn-off switching losses		-	105	-	μ J
E_{ts}	Total switching losses		-	150	-	μ J
$E_{on}^{(2)}$	Turn-on switching losses	$V_{CC} = 400\text{ V}$, $I_C = 5\text{ A}$ $R_G = 10\ \Omega$, $V_{GE} = 15\text{ V}$ $T_C = 150\text{ }^\circ\text{C}$	-	84	-	μ J
$E_{off}^{(3)}$	Turn-off switching losses		-	286	-	μ J
E_{ts}	Total switching losses		-	370	-	μ J

- Value guaranteed by design
- IGBT and diode are at the same temperature
- Turn-off losses include also the tail of the collector current

Table 8. Collector-emitter diode

Symbol	Parameter	Test conditions	Min	Typ.	Max	Unit
V_F	Forward on-voltage	$I_F = 3 \text{ A}$	-	1.75	2.5	V
		$I_F = 3 \text{ A}, T_C = 150 \text{ }^\circ\text{C}$	-	1.45		V
$t_{rr}^{(1)}$	Reverse recovery time	$I_F = 3 \text{ A}, V_R = 400 \text{ V},$ $di/dt = 100 \text{ A}/\mu\text{s}$	-	50		ns
$Q_{rr}^{(1)}$	Reverse recovery charge		-	45		nC
$I_{rm}^{(1)}$	Reverse recovery current		-	1.7		A
$t_{rr}^{(1)}$	Reverse recovery time	$I_F = 3 \text{ A}, V_R = 400 \text{ V},$ $T_C = 150 \text{ }^\circ\text{C},$ $di/dt = 100 \text{ A}/\mu\text{s}$	-	100		ns
$Q_{rr}^{(1)}$	Reverse recovery charge		-	150		nC
$I_{rm}^{(1)}$	Reverse recovery current		-	3.1		A

1. Limits guaranteed by design

2.1 Electrical characteristics (curves)

Figure 2. Output characteristics ($T_C = -50^\circ\text{C}$)

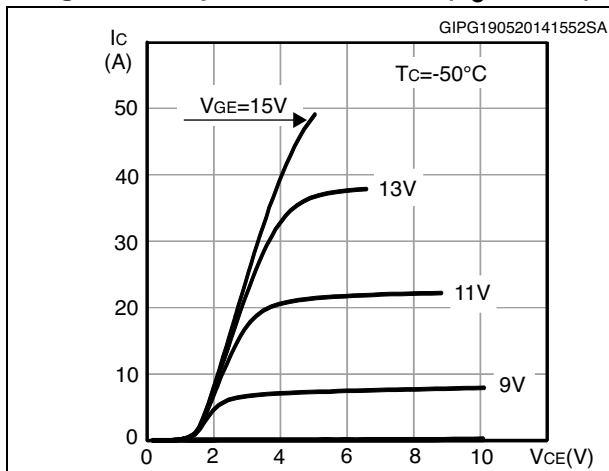

Figure 3. Output characteristics ($T_C = 25^\circ\text{C}$)

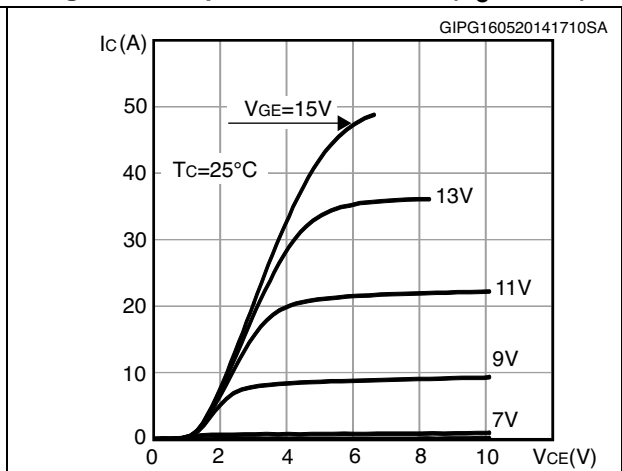

Figure 4. Output characteristics ($T_C = 150^\circ\text{C}$)

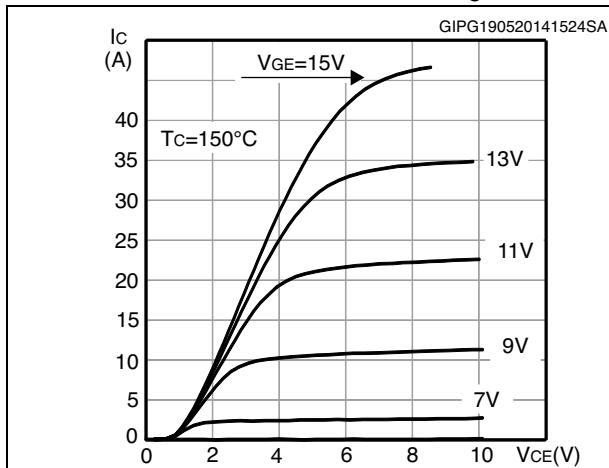

Figure 5. Transfer characteristics

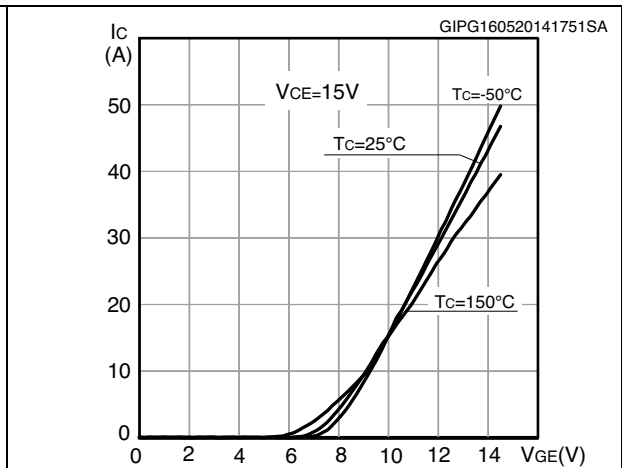

Figure 6. Collector-emitter on voltage vs. collector current

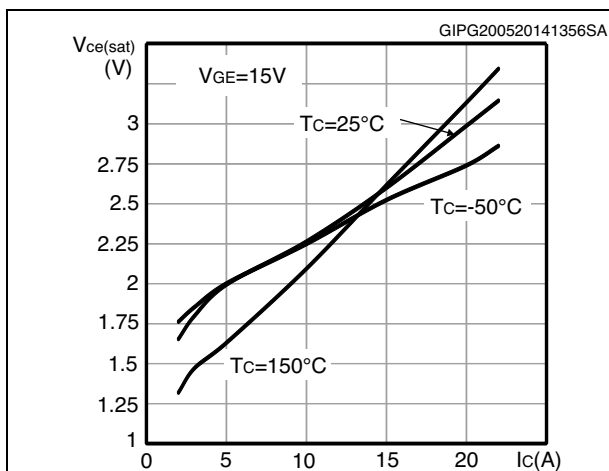

Figure 7. Collector-emitter on voltage vs. temperature

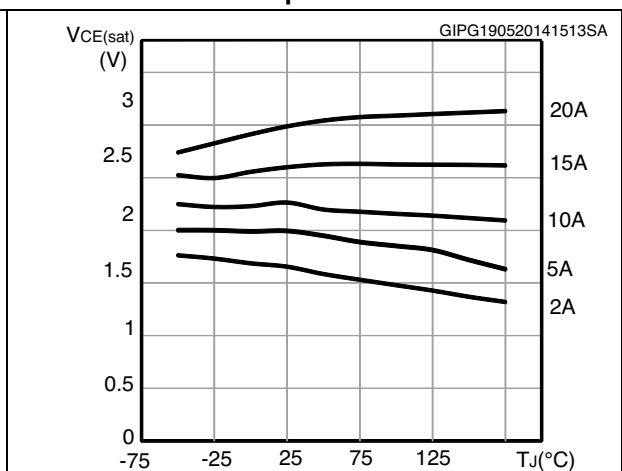

Figure 8. Normalized $V_{(BR)CES}$ vs. temperature

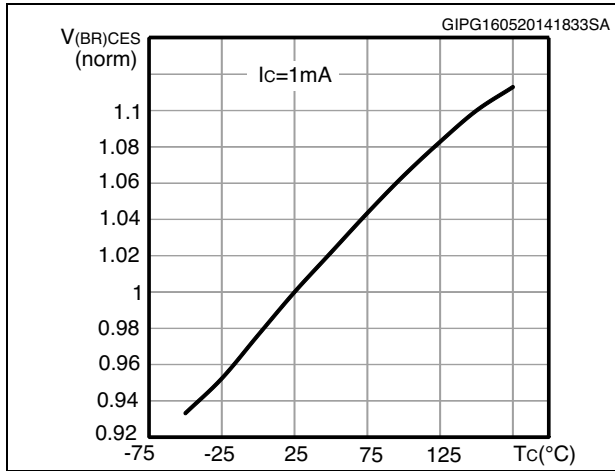

Figure 9. Normalized gate threshold vs. temperature

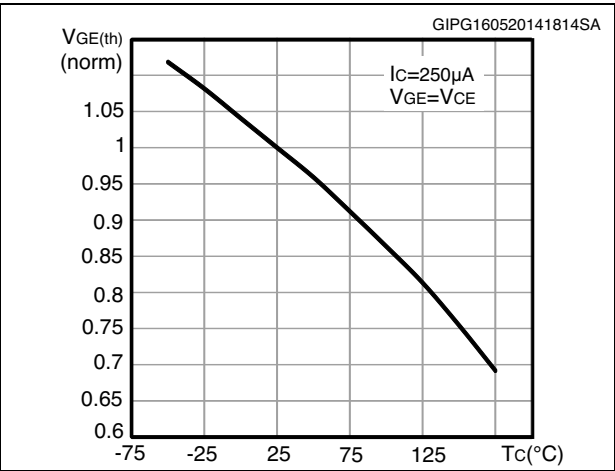

Figure 10. Gate charge vs. gate-emitter voltage

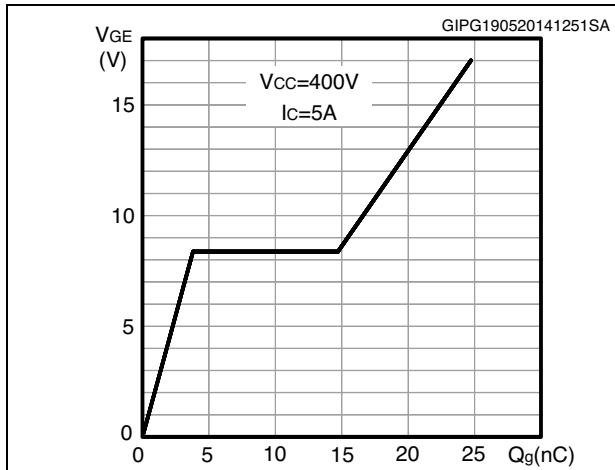

Figure 11. Capacitance variations

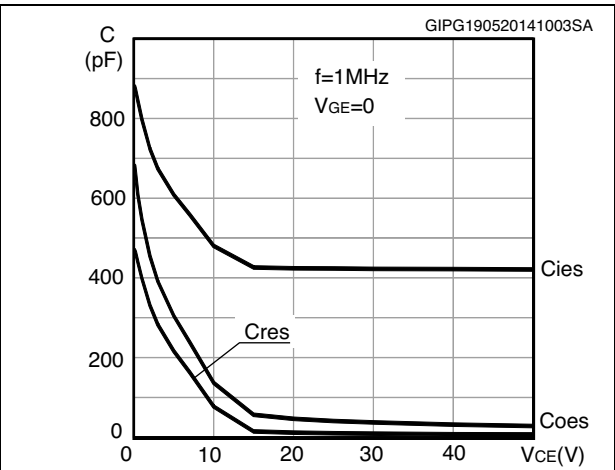

Figure 12. Switching losses vs. temperature

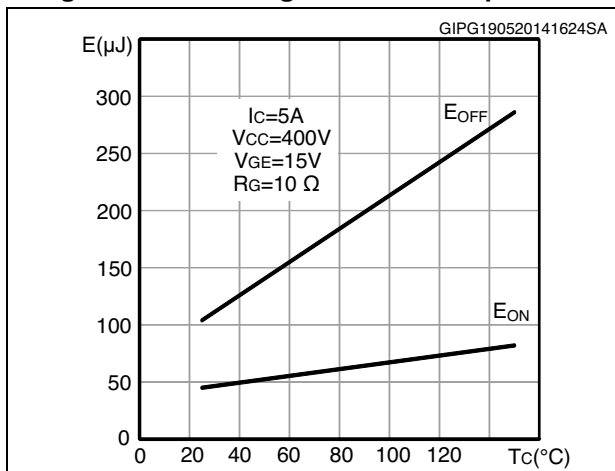

Figure 13. Switching losses vs. gate resistance

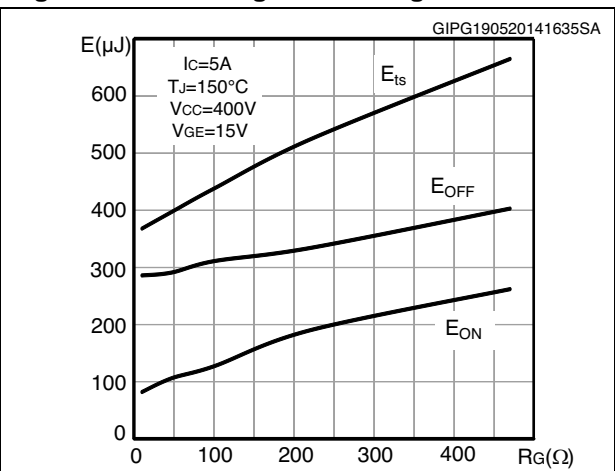

Figure 14. Switching losses vs. collector current

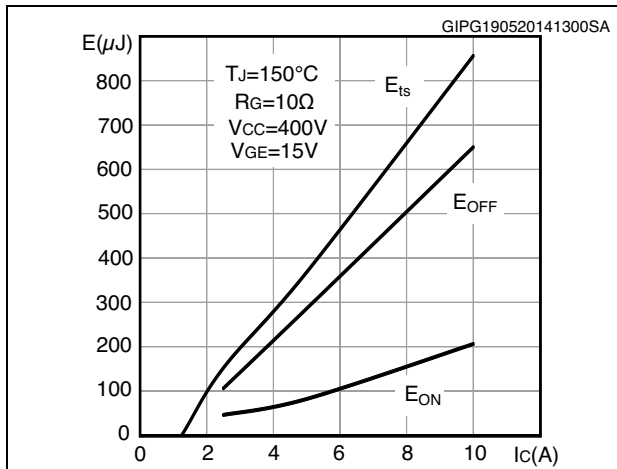

Figure 16. RBSOA

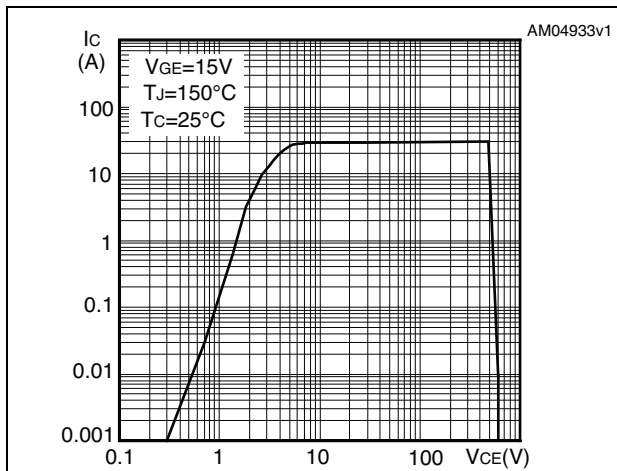

Figure 18. Switching times vs. gate resistance at Tj=150 °C

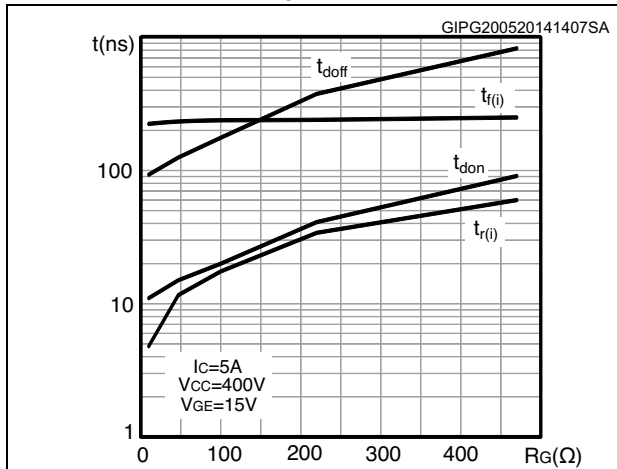

Figure 15. Short-circuit withstand time and current vs. gate-emitter voltage

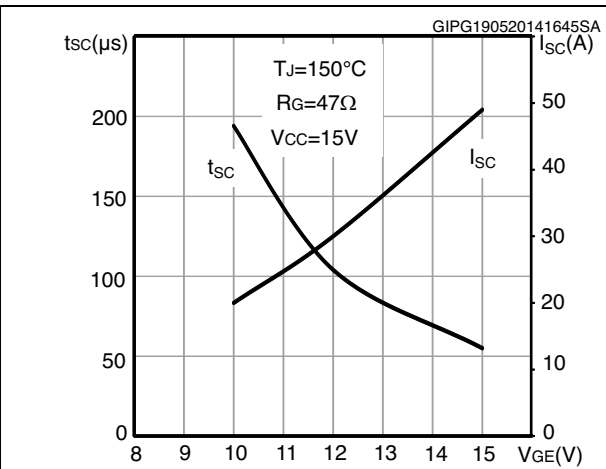

Figure 17. Switching times vs. gate resistance at Tj=25 °C

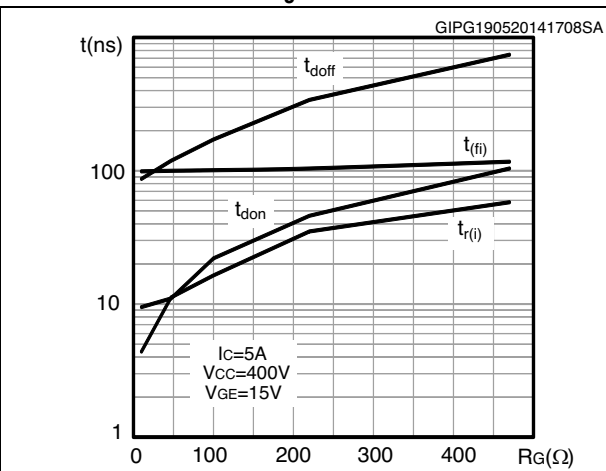

Figure 19. Switching times vs. collector current

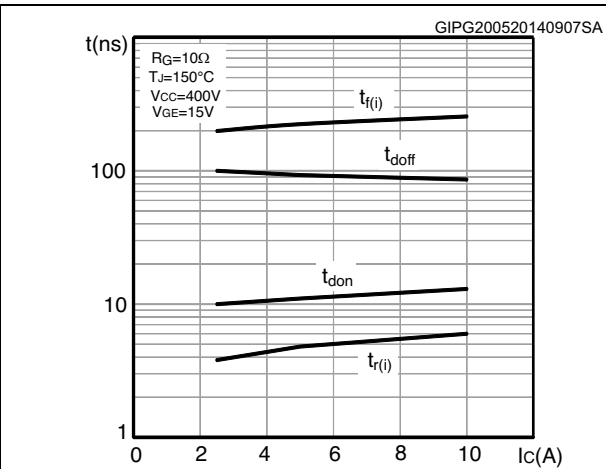

Figure 20. Diode forward voltage drop vs. forward current

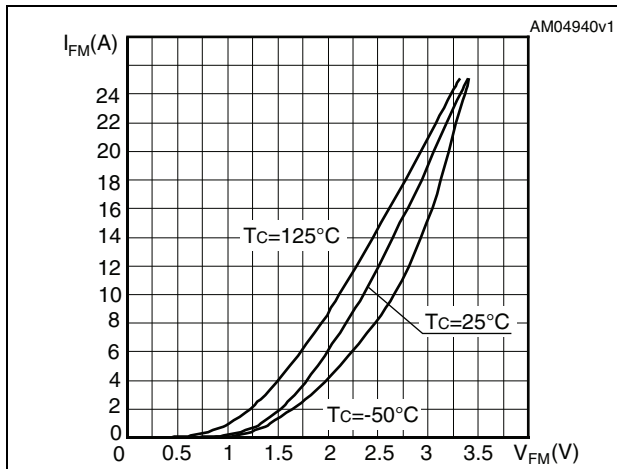

Figure 21. Peak reverse recovery current vs. di/dt

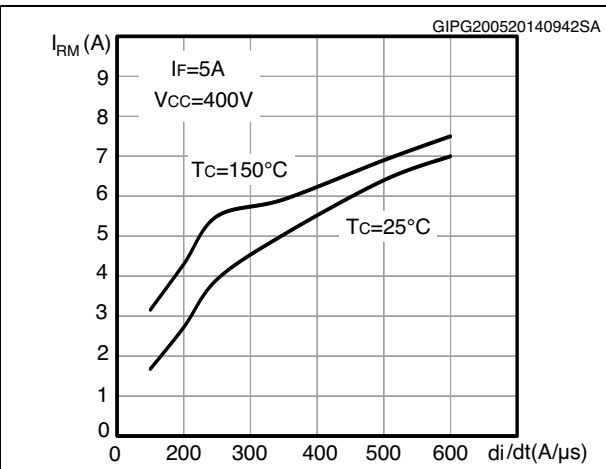

Figure 22. Reverse recovery time vs. di/dt

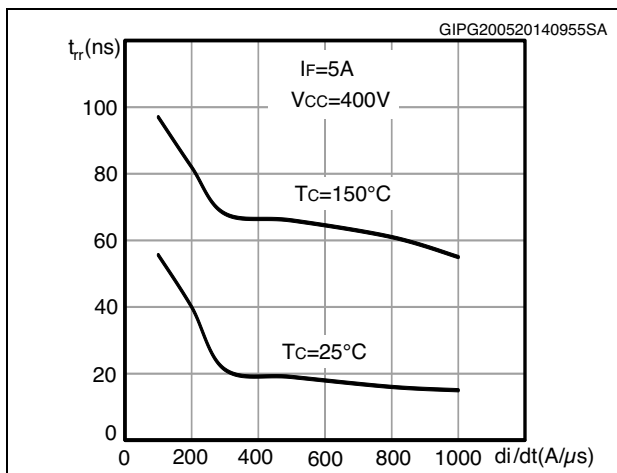

Figure 23. Reverse recovery softness factor vs. di/dt

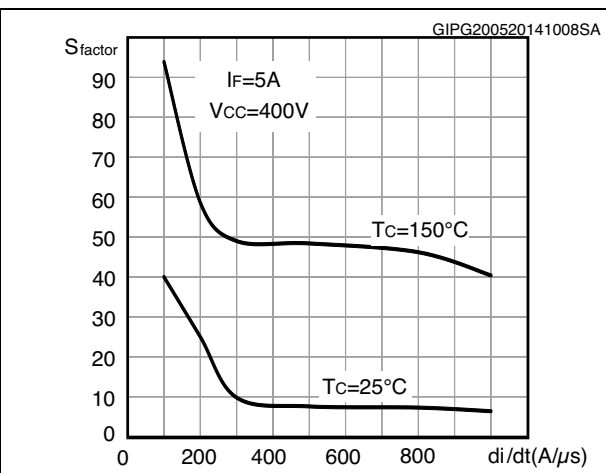

Figure 24. Reverse recovery charges vs. di/dt

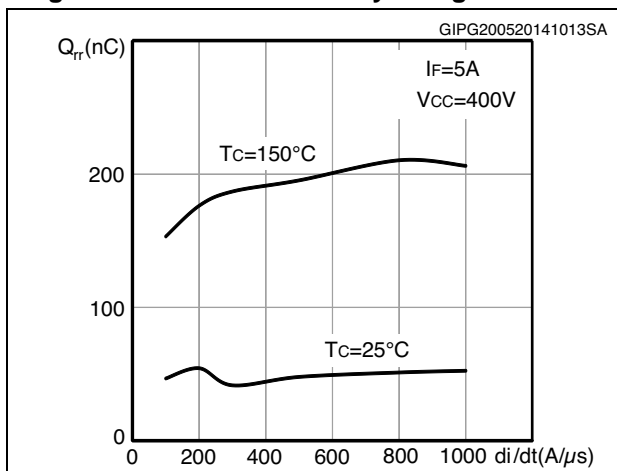

Figure 25. IGBT thermal impedance

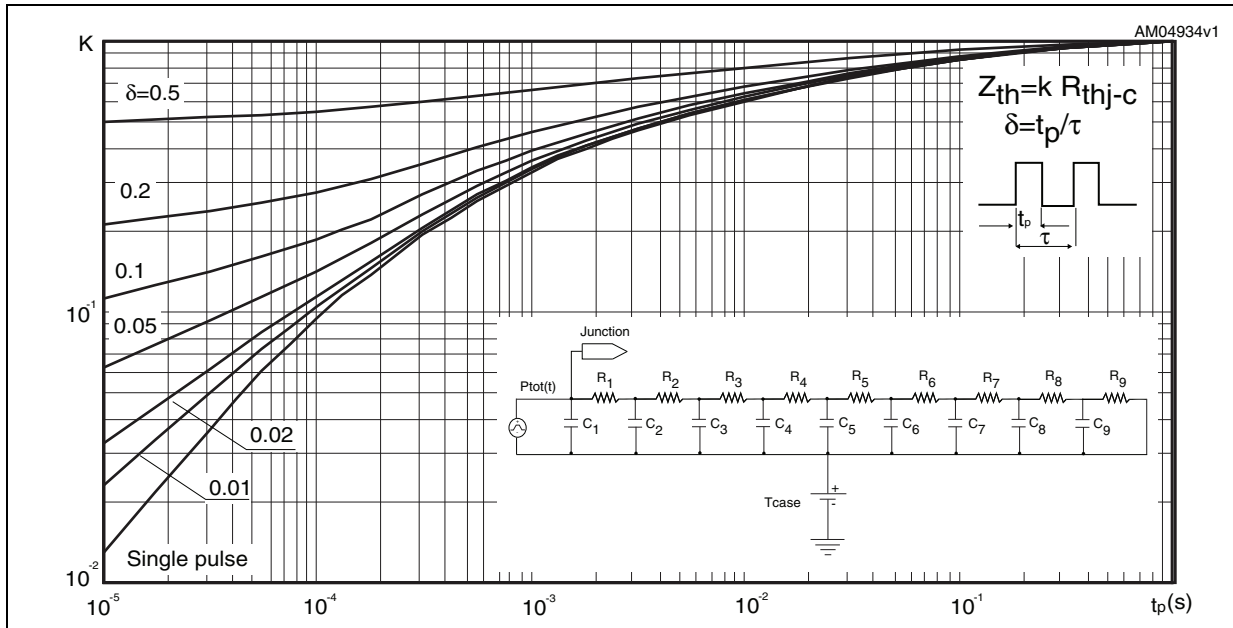

Table 9. IGBT RC-Cauer thermal network

Symbol	Value	Unit	Symbol	Value	Unit
R ₁	0.344	°C/W	C ₁	0.4E-3	W*s/°C
R ₂	0.0686	°C/W	C ₂	0.162E-4	W*s/°C
R ₃	0.0958	°C/W	C ₃	0.684E-3	W*s/°C
R ₄	0.177	°C/W	C ₄	0.923E-4	W*s/°C
R ₅	0.250	°C/W	C ₅	0.3E-2	W*s/°C
R ₆	0.245	°C/W	C ₆	0.9E-2	W*s/°C
R ₇	0.152	°C/W	C ₇	0.678E-3	W*s/°C
R ₈	0.135	°C/W	C ₈	0.807E-3	W*s/°C
R ₉	0.530	°C/W	C ₉	0.248	W*s/°C

Figure 26. Diode thermal impedance

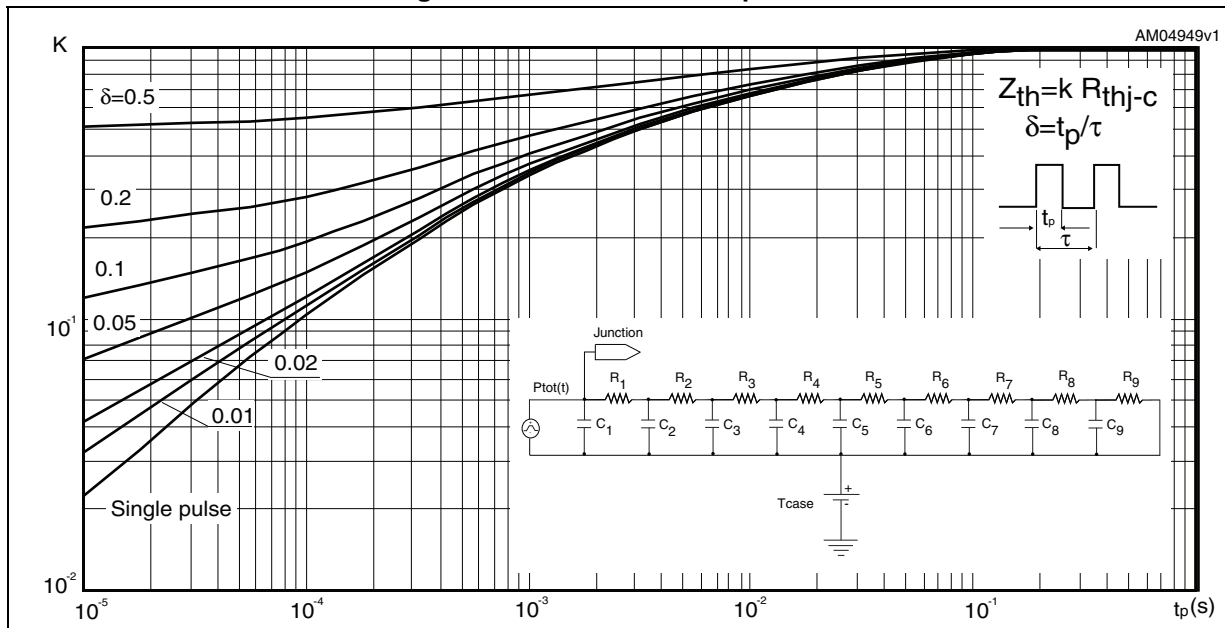
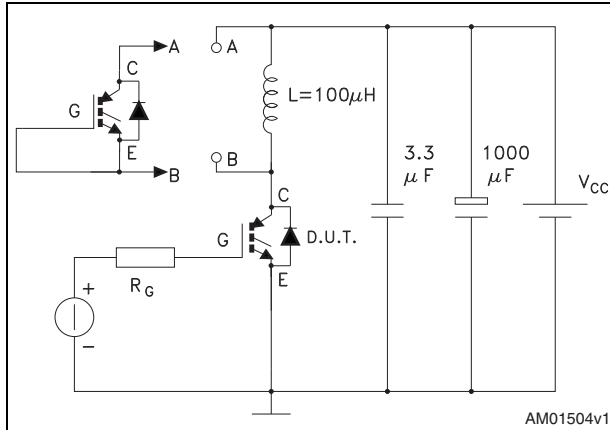

Table 10. Diode RC-Cauer thermal network

Symbol	Value	Unit	Symbol	Value	Unit
R ₁	0.478	°C/W	C ₁	0.8E-4	W*s/°C
R ₂	0.542	°C/W	C ₂	1E-4	W*s/°C
R ₃	0.600	°C/W	C ₃	2E-4	W*s/°C
R ₄	0.277	°C/W	C ₄	0.5E-5	W*s/°C
R ₅	0.844	°C/W	C ₅	0.145E-2	W*s/°C
R ₆	0.313	°C/W	C ₆	0.499E-4	W*s/°C
R ₇	0.108	°C/W	C ₇	0.727E-3	W*s/°C
R ₈	0.891	°C/W	C ₈	0.393E-4	W*s/°C
R ₉	1.73	°C/W	C ₉	0.0176	W*s/°C

3 Test circuits

Figure 27. Test circuit for inductive load switching



AM01504v1

Figure 28. Gate charge test circuit

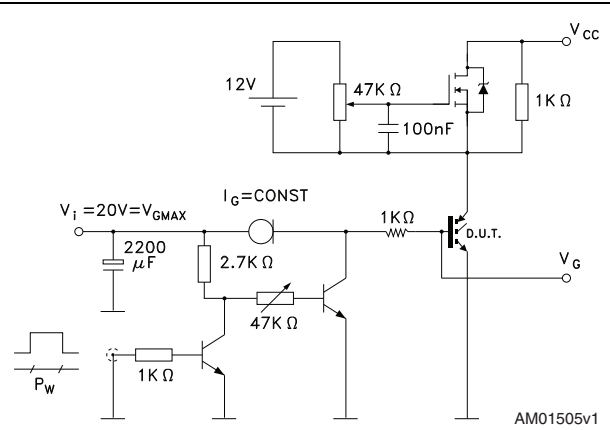

AM01505v1

Figure 29. Switching waveforms

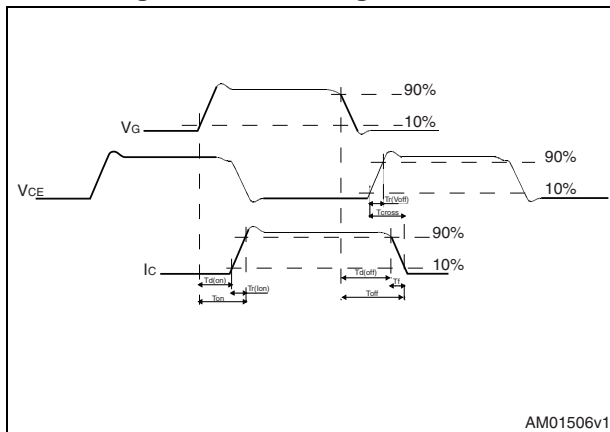

AM01506v1

Figure 30. Diode recovery times waveform

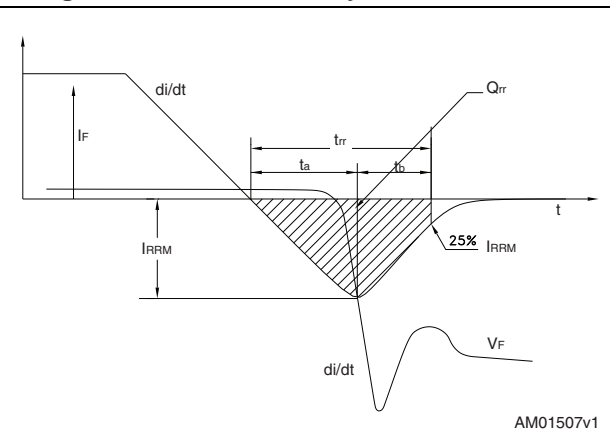

AM01507v1

4 Package mechanical data

In order to meet environmental requirements, ST offers these devices in different grades of ECOPACK[®] packages, depending on their level of environmental compliance. ECOPACK[®] specifications, grade definitions and product status are available at: www.st.com. ECOPACK[®] is an ST trademark.

Figure 31. DPAK (TO-252) type A drawing

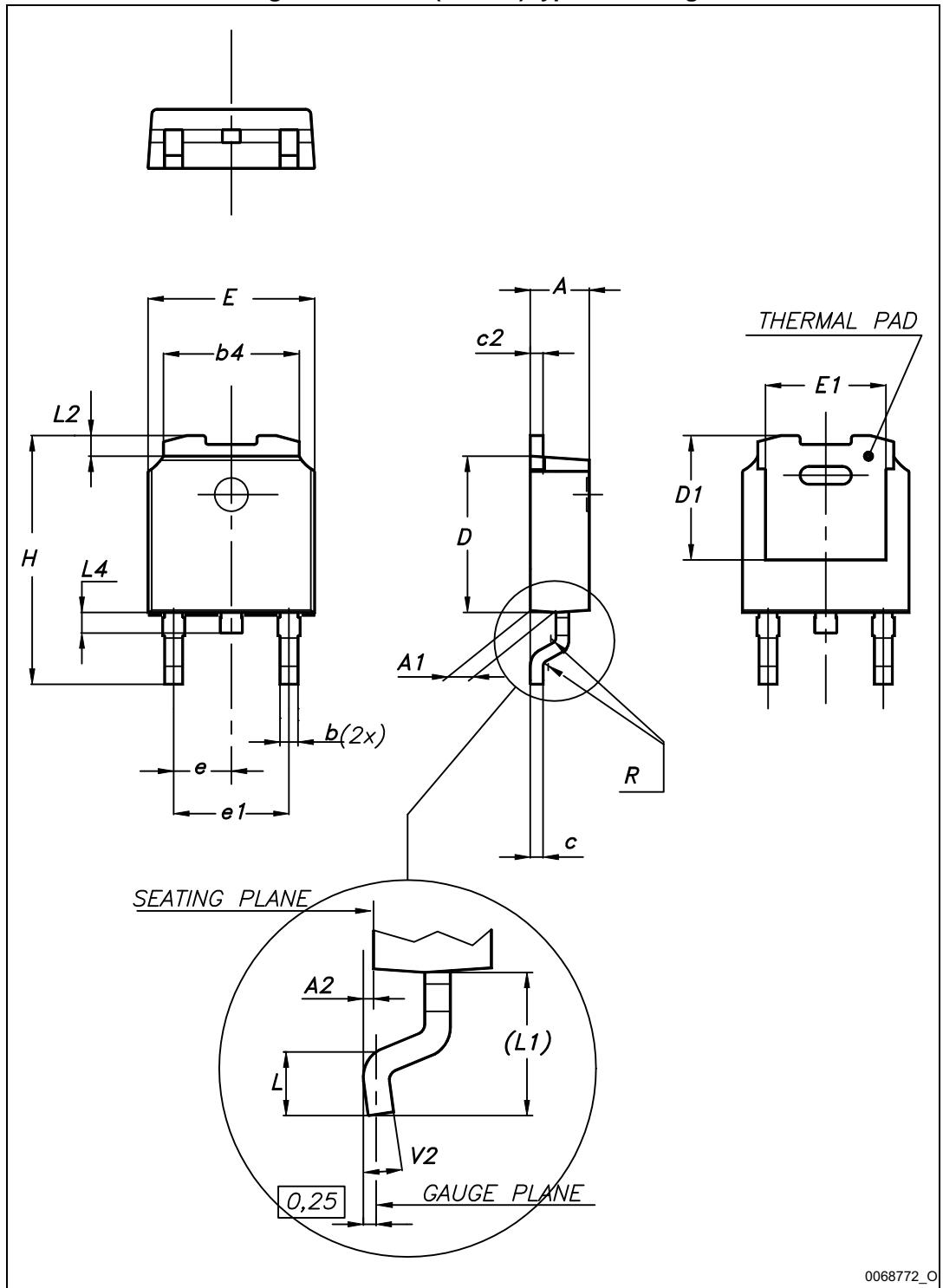

0068772_0

Table 11. DPAK (TO-252) type A mechanical data

Dim.	mm		
	Min.	Typ.	Max.
A	2.20		2.40
A1	0.90		1.10
A2	0.03		0.23
b	0.64		0.90
b4	5.20		5.40
c	0.45		0.60
c2	0.48		0.60
D	6.00		6.20
D1		5.10	
E	6.40		6.60
E1		4.70	
e		2.28	
e1	4.40		4.60
H	9.35		10.10
L	1.00		1.50
(L1)		2.80	
L2		0.80	
L4	0.60		1.00
R		0.20	
V2	0°		8°

Figure 32. DPAK (TO-252) type A footprint (a)

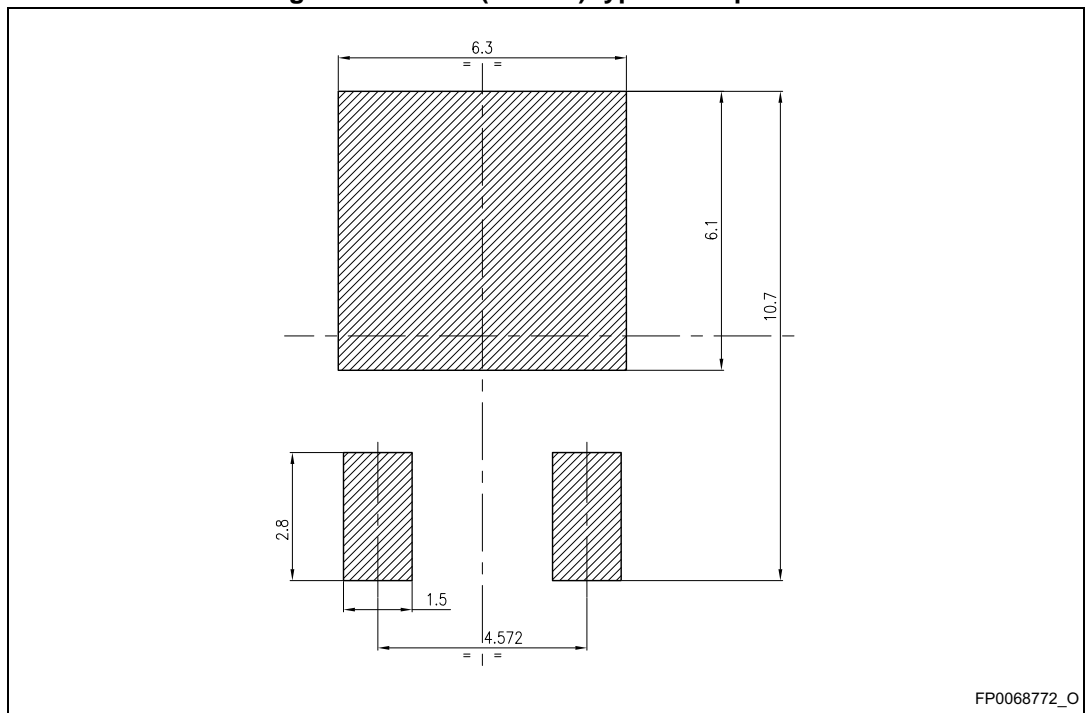

a. All dimensions are in millimeters

5 Packaging mechanical data

Figure 33. Tape for DPAK (TO-252)

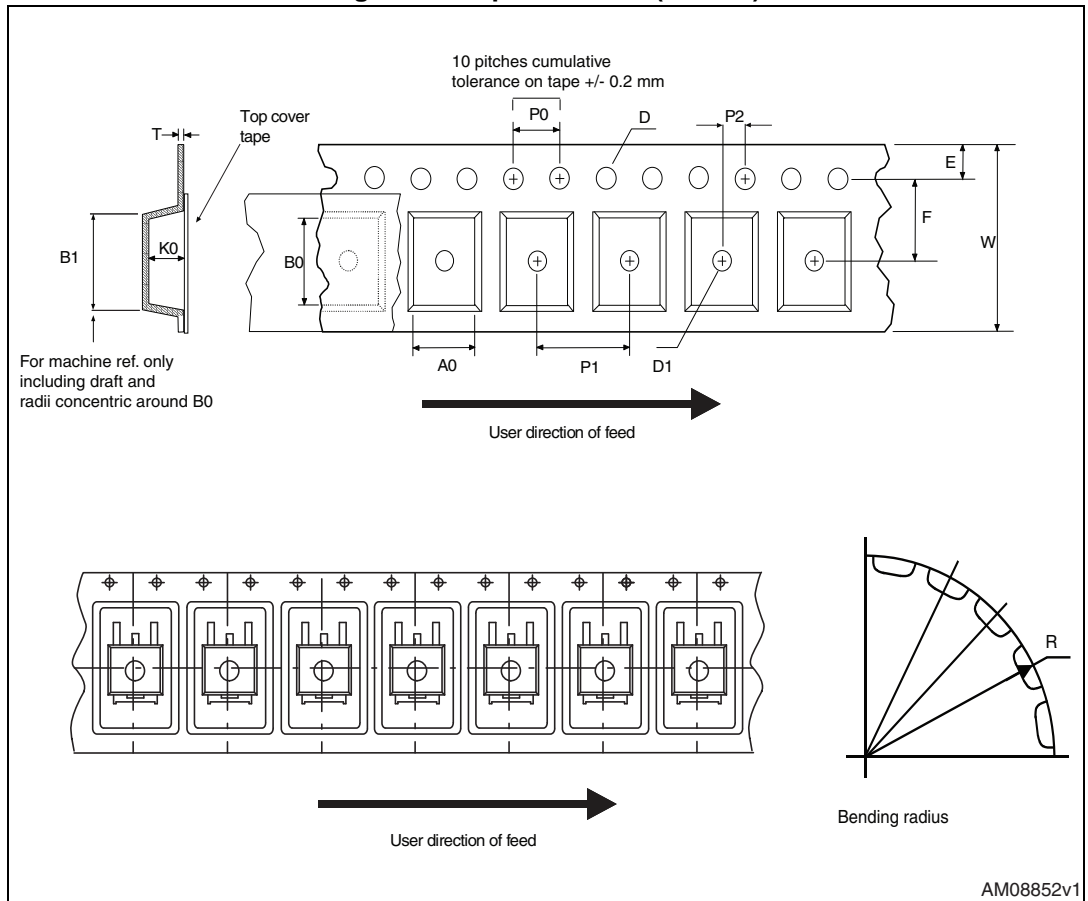
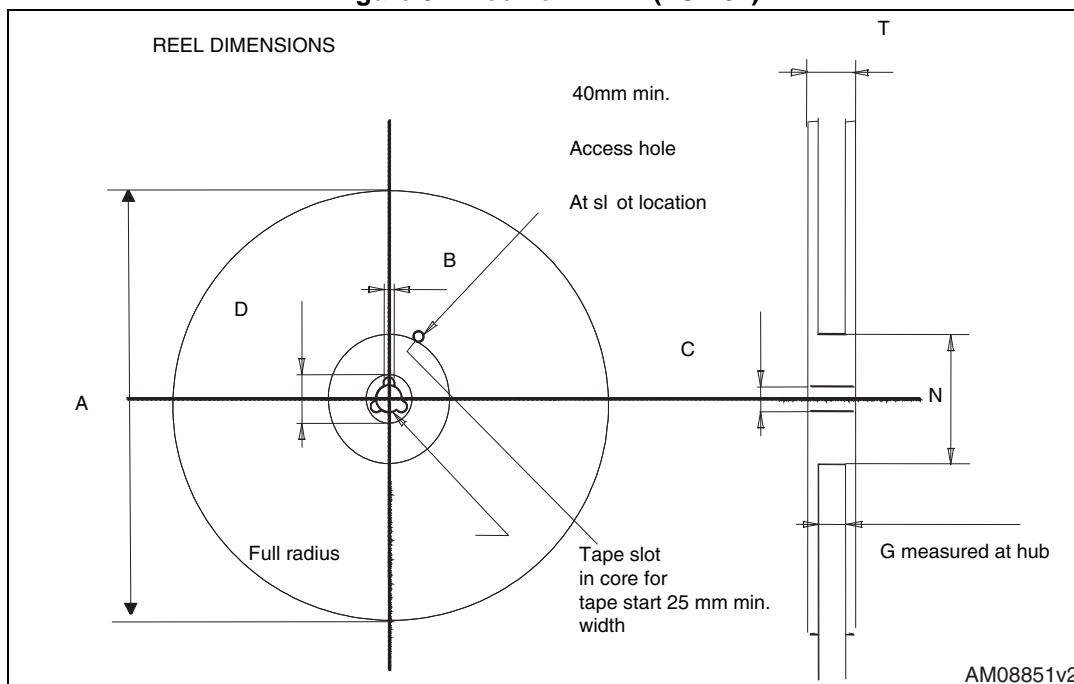

Figure 34. Reel for DPAK (TO-252)



AM08851v2

Table 12. DPAK (TO-252) tape and reel mechanical data

Tape			Reel		
Dim.	mm		Dim.	mm	
	Min.	Max.		Min.	Max.
A0	6.8	7	A		330
B0	10.4	10.6	B	1.5	
B1		12.1	C	12.8	13.2
D	1.5	1.6	D	20.2	
D1	1.5		G	16.4	18.4
E	1.65	1.85	N	50	
F	7.4	7.6	T		22.4
K0	2.55	2.75			
P0	3.9	4.1		Base qty.	2500
P1	7.9	8.1		Bulk qty.	2500
P2	1.9	2.1			
R	40				
T	0.25	0.35			
W	15.7	16.3			

6 Revision history

Table 13. Document revision history

Date	Revision	Changes
28-Feb-2012	1	First release
27-May-2014	2	<ul style="list-style-type: none">– Added: Section 2.1: Electrical characteristics (curves)– Updated: Section 4: Package mechanical data– Minor text changes

Please Read Carefully:

Information in this document is provided solely in connection with ST products. STMicroelectronics NV and its subsidiaries ("ST") reserve the right to make changes, corrections, modifications or improvements, to this document, and the products and services described herein at any time, without notice.

All ST products are sold pursuant to ST's terms and conditions of sale.

Purchasers are solely responsible for the choice, selection and use of the ST products and services described herein, and ST assumes no liability whatsoever relating to the choice, selection or use of the ST products and services described herein.

No license, express or implied, by estoppel or otherwise, to any intellectual property rights is granted under this document. If any part of this document refers to any third party products or services it shall not be deemed a license grant by ST for the use of such third party products or services, or any intellectual property contained therein or considered as a warranty covering the use in any manner whatsoever of such third party products or services or any intellectual property contained therein.

UNLESS OTHERWISE SET FORTH IN ST'S TERMS AND CONDITIONS OF SALE ST DISCLAIMS ANY EXPRESS OR IMPLIED WARRANTY WITH RESPECT TO THE USE AND/OR SALE OF ST PRODUCTS INCLUDING WITHOUT LIMITATION IMPLIED WARRANTIES OF MERCHANTABILITY, FITNESS FOR A PARTICULAR PURPOSE (AND THEIR EQUIVALENTS UNDER THE LAWS OF ANY JURISDICTION), OR INFRINGEMENT OF ANY PATENT, COPYRIGHT OR OTHER INTELLECTUAL PROPERTY RIGHT.

ST PRODUCTS ARE NOT DESIGNED OR AUTHORIZED FOR USE IN: (A) SAFETY CRITICAL APPLICATIONS SUCH AS LIFE SUPPORTING, ACTIVE IMPLANTED DEVICES OR SYSTEMS WITH PRODUCT FUNCTIONAL SAFETY REQUIREMENTS; (B) AERONAUTIC APPLICATIONS; (C) AUTOMOTIVE APPLICATIONS OR ENVIRONMENTS, AND/OR (D) AEROSPACE APPLICATIONS OR ENVIRONMENTS. WHERE ST PRODUCTS ARE NOT DESIGNED FOR SUCH USE, THE PURCHASER SHALL USE PRODUCTS AT PURCHASER'S SOLE RISK, EVEN IF ST HAS BEEN INFORMED IN WRITING OF SUCH USAGE, UNLESS A PRODUCT IS EXPRESSLY DESIGNATED BY ST AS BEING INTENDED FOR "AUTOMOTIVE, AUTOMOTIVE SAFETY OR MEDICAL" INDUSTRY DOMAINS ACCORDING TO ST PRODUCT DESIGN SPECIFICATIONS. PRODUCTS FORMALLY ESCC, QML OR JAN QUALIFIED ARE DEEMED SUITABLE FOR USE IN AEROSPACE BY THE CORRESPONDING GOVERNMENTAL AGENCY.

Resale of ST products with provisions different from the statements and/or technical features set forth in this document shall immediately void any warranty granted by ST for the ST product or service described herein and shall not create or extend in any manner whatsoever, any liability of ST.

ST and the ST logo are trademarks or registered trademarks of ST in various countries.
Information in this document supersedes and replaces all information previously supplied.

The ST logo is a registered trademark of STMicroelectronics. All other names are the property of their respective owners.

© 2014 STMicroelectronics - All rights reserved

STMicroelectronics group of companies

Australia - Belgium - Brazil - Canada - China - Czech Republic - Finland - France - Germany - Hong Kong - India - Israel - Italy - Japan - Malaysia - Malta - Morocco - Philippines - Singapore - Spain - Sweden - Switzerland - United Kingdom - United States of America

www.st.com



Mouser Electronics

Authorized Distributor

Click to View Pricing, Inventory, Delivery & Lifecycle Information:

[STMicroelectronics:](#)

[STGD10HF60KD](#)