

The accessory IC series for the video



Video isolation amplifier

BH7673G

No.15069EBT01

•General

BH7673G is the single isolation video amplifier. It can reject the external noise when it receives the signal outside of the application. It can reduce the influence of the external noise substantially. Because it has high common mode noise rejection ratio (-60dB Typ.). It is the best for the application of automotives, because it is able to use a wide range of temperature and it has the high electrostatic discharge rating. Moreover, because the frequency characteristic can correspond to the Hi-Vision signal, it is at the development to equal to or more than 30 MHz.

•Features

- 1) The high Electrostatic discharge(ESD) rating (The human body model: $\pm 6000V$ pass)
- 2) Able to use a wide range of temperature, from $-40^{\circ}C$ to $+85^{\circ}C$
- 3) High common mode rejection ratio(Typ. -60dB, $f=20kHz$)
- 4) It is not the degradation of CMRR when inserting ESD resistance at the input terminal.
- 5) Wide band [suitable for D4 standard] (0dB at $f=30MHz$)
- 6) Wide output dynamic range(Typ. 3.8Vpp)
- 7) High input Impedance(Typ. 150k Ω)
- 8) Low circuit current consumption(Typ. 4.8mA)
- 9) Bias input
- 10) SSOP5 small package

•Applications

The car navigation systems, the car monitor etc.

The signal input to the rear monitor, the picture taking-in from the rear camera and the measure of the noise when pulling around a video signal out of the substrate.

•Absolute Maximum Ratings (Ta=25°C)

Parameter	Symbol	Limits	Unit
Supply voltage	VCC	7.0	V
Power dissipation	Pd	540 * ¹	mW
Input voltage range	V _{IN}	0~VCC+0.2	V
Operating temperature	Topr	-40~+85	°C
Storage temperature	Tstg	-55~+125	°C

* Reduced by 5.4mW/°C at 25°C or higher
When mounting on a 70mmX70mmX1.6mm PCB board.

•Operating Condition (Ta=25°C)

Parameter	Symbol	Min.	Typ.	Max	Unit
Supply voltage	VCC	4.5	5.0	5.5	V

* This product is not designed for protection against radioactive rays.

●Electrical characteristics (Unless otherwise specified, Ta= 25°C, VCC=5.0V)

Parameter	Symbol	Min.	Typ.	Max.	Unit	Conditions
Circuit current	ICC	—	4.8	8.0	mA	No signal
Maximum output level	V _{OM}	3.2	3.8	—	V _{pp}	f=10kHz, THD=1.0%
Voltage gain	G _V	-1.0	0.0	1.0	dB	V _{in} =1.0V _{pp} , f=1MHz
Frequency characteristics 1	G _{F1}	-1.0	0.0	1.0	dB	V _{in} =1.0V _{pp} , f=10MHz/1MHz
Frequency characteristics 2	G _{F2}	—	0.0	—	dB	V _{in} =1.0V _{pp} , f=30MHz/1MHz
Common mode rejection ratio	CMRR	—	-60	-40	dB	V _{in} =1.0V _{pp} , f=20kHz
Input Impedance	Z _{IN}	110	150	190	kΩ	
Differential gain	D _G	—	0.1	—	%	V _{in} =1.0V _{pp} , Standard stair step signal
Differential phase	D _P	—	0.3	—	deg.	V _{in} =1.0V _{pp} , Standard stair step signal
S/N _Y	S/N _Y	—	70	—	dB	V _{in} =1.0V _{pp} , bandwidth 100k~6MHz 100% white video signal
Electrostatic discharge rating (The human body model)	HBM	—	±6	—	kV	R=1.5kΩ, C=100pF

●Block diagram

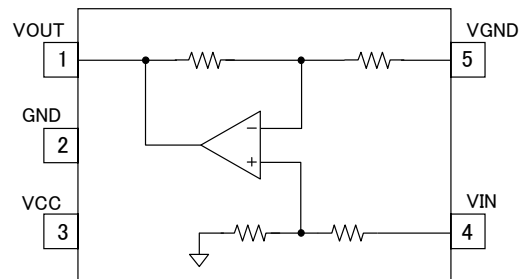

•I/O equivalent circuit diagrams

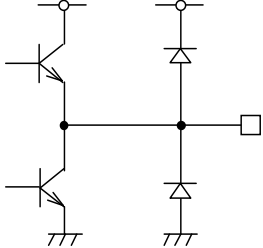
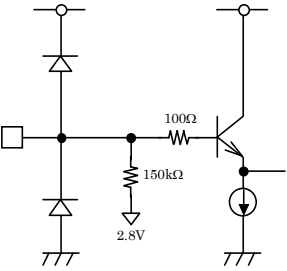
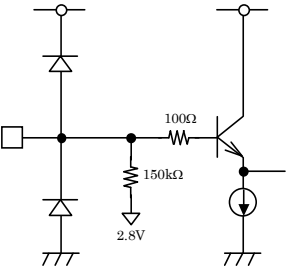
PIN	Name	Equivalent circuit	DC voltage	The function explanation
1	VOUT		2.1V	Video signal output pin. Use load resistance at equal to or more than 2 kΩ. VOUT pin cannot drive 75Ω.
2	GND	—	0V	GND pin
3	VCC	—	5V	VCC pin
4	VIN		2.8V	Video signal input pin is used for bias type input. Input impedance is 150 kΩ.
5	VGND		2.8V	The bias type input. Input Impedance is 150kΩ

Note1) The above DC potential is only when VCC = 5V. This value is a reference value and is not guaranteed.

Note2) Numerical values shown in these figures are design values, and compliance to standards is not guaranteed.

•Test Circuit Diagrams

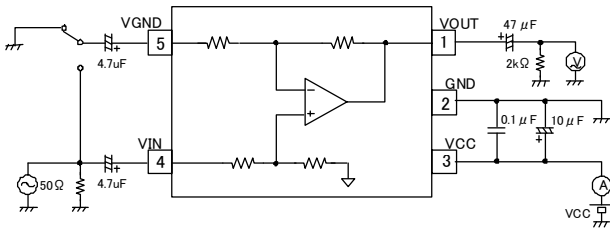

Fig.1 Test Circuit Diagram

Test circuit diagrams are used for shipment inspections, and differ from application circuits.

•Application circuit examples

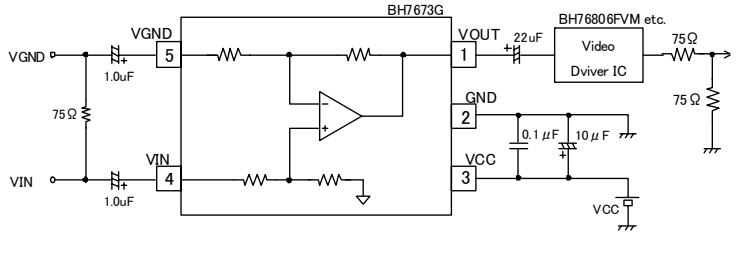

Fig.2 Application circuit examples

See pages 6 for description of how to determine the capacity of I/O coupling capacitors. This IC cannot drive 75Ω directly. When driving 75Ω, connect a video driver such as BH76806FVM behind this IC.

•Evaluation board pattern diagram and circuit diagram

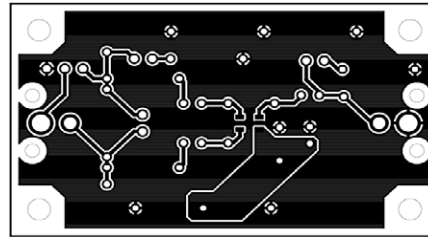
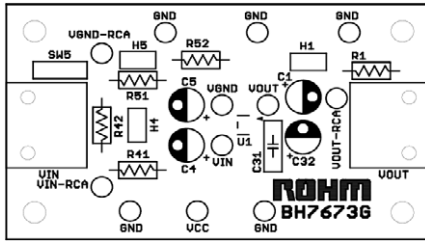

Fig.3 Evaluation Board Pattern Diagram

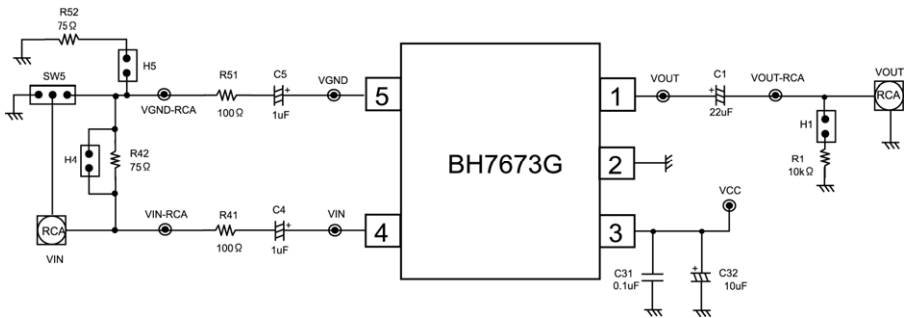

Fig.4 Evaluation Board Circuit Diagram

Parts list

Symbol	Function	Recommended value	Comments
R42 R52	Input terminating resistor	50Ω, 75Ω, 600Ω etc.	
R41 R51	Surge Resistance	unless 1kΩ	It adds according to the necessity.
C4 C5	Input coupling capacitor	1.0μF (See pages 6 to determine)	Recommended B characteristics
R1	The load resistance	2kΩ over	
C1	Output coupling capacitor	See pages 6 to determine	Recommended B characteristics
C32	Decoupling capacitor	10μF	Recommended B characteristics
C31		0.1μF	

•About the setting of a jumper switch

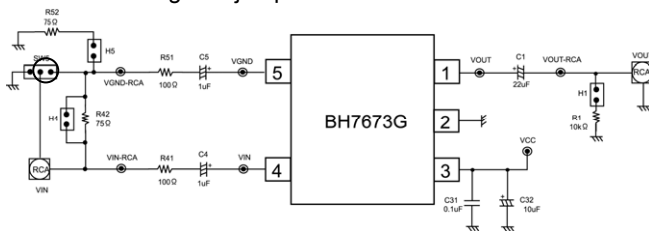

Fig.5 Generally, it is when evaluating.

Make SW5 connection H4 on the side of the circuit and make H5 OPEN.

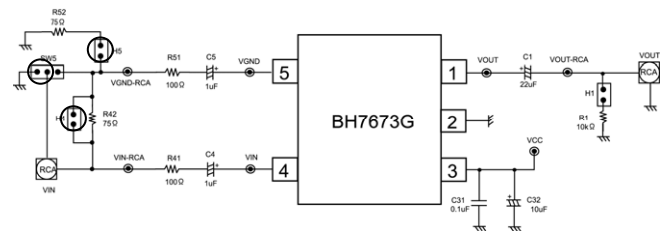

Fig.6 CMRR measurement

Make SW5 connection H4 at the circuit and on the opposite side and make H5 ON.

●Cautions for use

1. The numerical values and data shown here are typical design values, not guaranteed values.
2. The application circuit examples show recommended circuits, but characteristics should be checked carefully before using these circuits. If any external part constants are modified before use, factors such as variation in all external parts and ROHM LSI ICs, including not only static characteristics but also transient characteristics, should be fully considered to set an ample margin.
3. Absolute maximum ratings

If the absolute maximum ratings for applied voltage and/or operation temperature are exceeded, LSI damage may result. Therefore, do not apply voltage or use in a temperature that exceeds these absolute maximum ratings. If it is possible that absolute maximum ratings will be exceeded, use a physical safety device such as a fuse and make sure that no conditions that might exceed the absolute maximum ratings will be applied to the LSI IC.
4. GND potential

Regardless of the operation mode, the voltage of the GND pin should be at least the minimum voltage. Actually check whether or not the voltage at each pin, including transient phenomena, is less than the GND pin voltage.
5. Thermal design

The thermal design should be done using an ample margin that takes into consideration the allowable dissipation under actual use conditions.
6. Shorts between pins and mounting errors

When mounting LSI ICs onto the circuit board, make sure each LSI's orientation and position is correct. The ICs may become damaged if they are not mounted correctly when the power is turned on. Similarly, damage may also result if a short occurs, such as when a foreign object is positioned between pins in an IC, or between a pin and a power supply or GND connection
7. Operation in strong electromagnetic field

When used within a strong electromagnetic field, evaluate carefully to avoid the risk of operation faults
8. Place the power supply's decoupling capacitor as close as possible to the VCC pin (PIN 3) and GND pin (PIN 2).
9. The parasitic capacitance of the application board may cause the peak of the frequency characteristic response to occur at a high frequency. To lower the peak of the frequency characteristic, connect in series resistors having resistance of several dozen ohm to several hundred ohm as close as possible to the output pin.

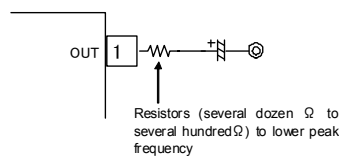

Fig.7 Positions where Resistors are Inserted to Lower Peak Frequency Response

10. The attention point when treating HD signal

As shown in reference data Fig.20, BH7673G have the frequency characteristic of equal to or more than 30 MHz but by the influence with the parasitic capacitance of the application board and so on, a characteristic as in the carrying data isn't sometimes gotten. The frequency characteristic can be improved in inserting about $2k\Omega \sim 3k\Omega$ resistance between the output terminal and the GND terminal to the case.

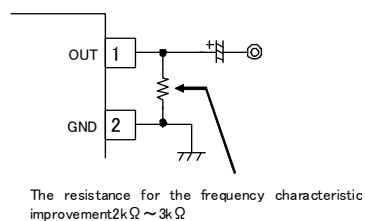

Fig.8 The resistance insertion position for the frequency characteristic improvement

●Cautions for selection and use of application parts

Method for determining capacity of input coupling capacitor

The input coupling capacitor and input impedance Z_{in} ($=150k\Omega$) inside the IC composes HPF.

When the cutoff frequency(f_c) of HPF takes from 1 Hz to be computed by the following formula (a). The value of the input coupling capacitor is computed with the degree as much as 1 μ F (Generally, the f_c takes from equal to or less than several Hz).

$$f_c = 1 / (2\pi \times C \times Z_{in}) \dots (a)$$

When evaluating the Sag characteristics and determining the capacity of the capacitor during video signal input, a horizontal stripe signal called "H bar" (shown in Fig.9) is suitable, and this type of signal is used instead of a color bar signal to evaluate characteristics and determine capacity.



Fig.9 Example of Screen with Obvious Sag (H-bar Signal)

Method for determining capacity of output coupling capacitor

The HPF is formed in the same way by the output coupling capacitor and the input impedance of the IC which connects with the following paragraph by the video output terminal, so estimate an output coupling capacitor with necessary capacity according to the formula (a).

The case of insert surge resistor at VIN and VGND terminals

Use the same value resistance when insert surge resistor(Fig.4 R41 and R51) at video input terminals(max value: 1k Ω). The degradation of CMRR etc are not deteriorating when inserting resistance with the same value.

● Reference data [Unless otherwise specified, VCC=5V, Ta=25°C]

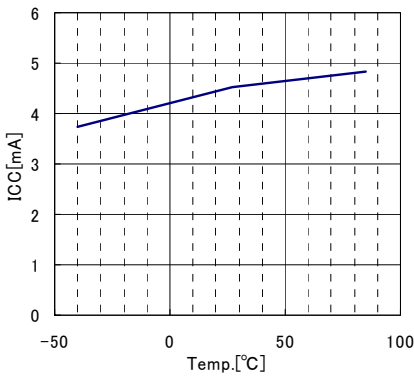

Fig.10
Circuit Current vs.
Ambient Temperature

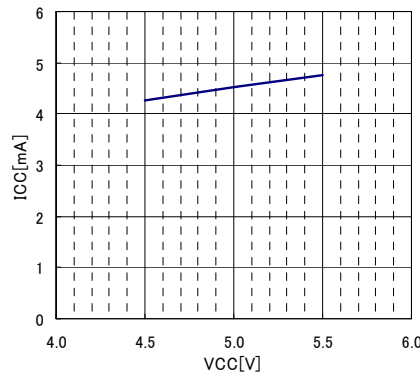

Fig.11
Circuit Current vs.
Supply Voltage

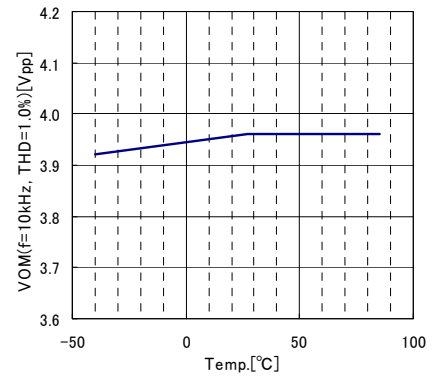

Fig.12
Maximum Output Level vs.
Ambient Temperature

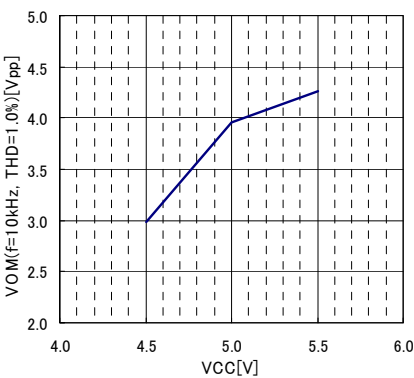

Fig.13
Maximum Output Level vs.
Supply Voltage

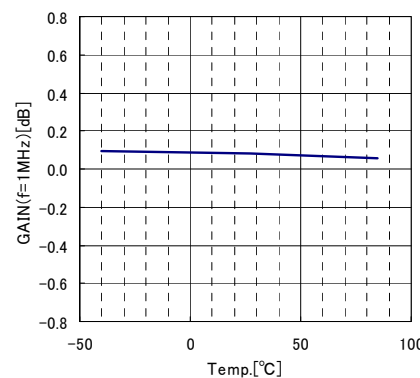

Fig.14
Gain vs.
Ambient Temperature

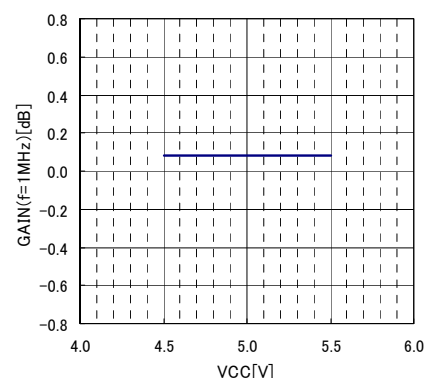

Fig.15
Gain vs.
Supply Voltage

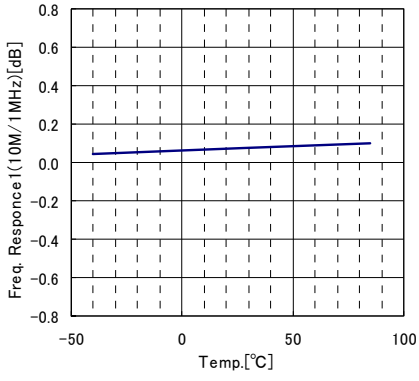

Fig. 16
Frequency Response1 vs.
Ambient Temperature

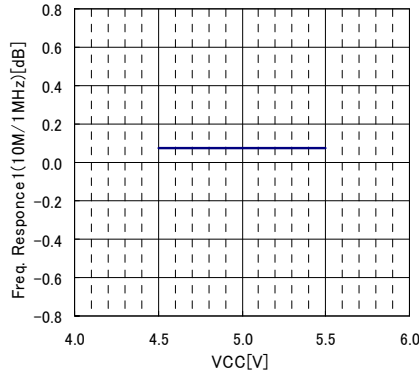

Fig. 17
Frequency Response1 vs.
Supply Voltage

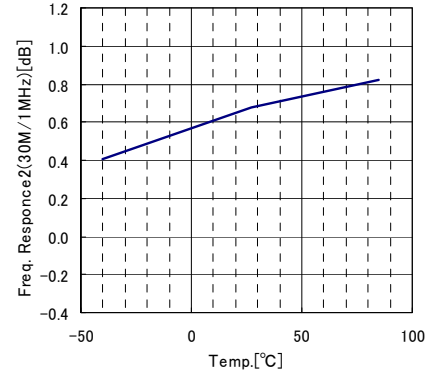

Fig. 18
Frequency Response2 vs.
Ambient Temperature

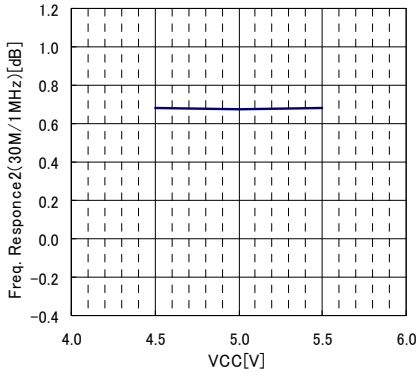

Fig. 19
Frequency Response2 vs.
Supply Voltage

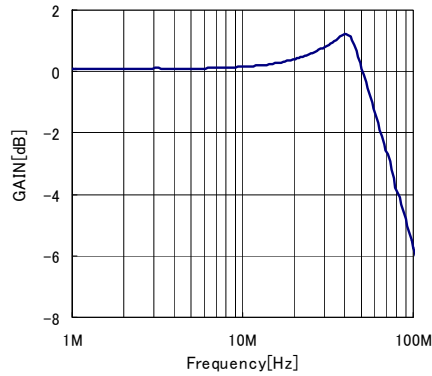

Fig. 20
Gain vs. Frequency

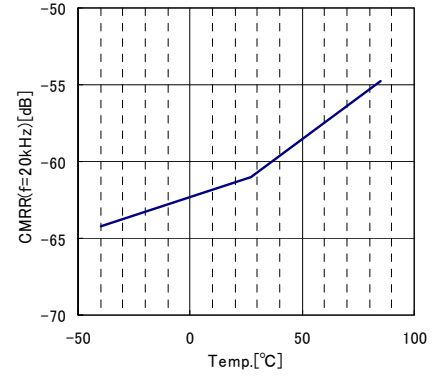

Fig. 21
Common Mode Rejection Ratio vs.
Ambient Temperature

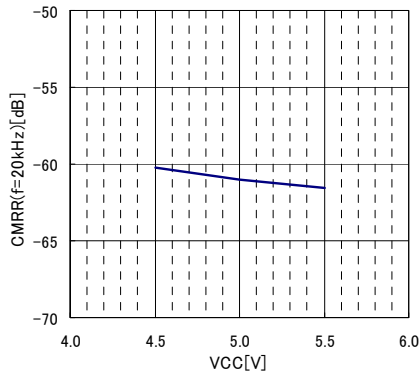

Fig. 22
Common Mode Rejection Ratio vs.
Supply Voltage

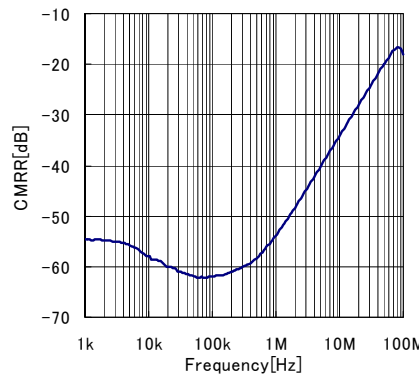

Fig. 23
Common Mode Rejection Ratio vs.
Frequency

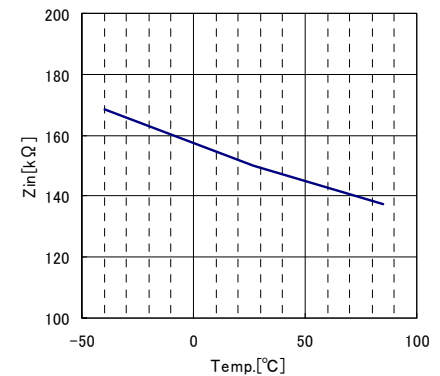

Fig. 24
Input Impedance vs.
Ambient Temperature

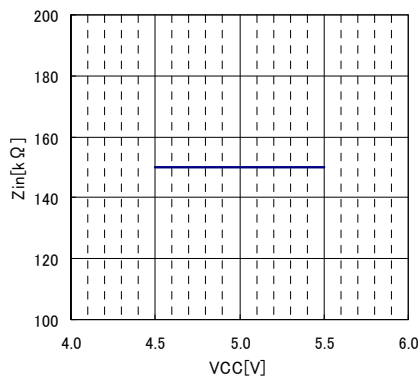

Fig. 25
Input Impedance vs.
Supply Voltage

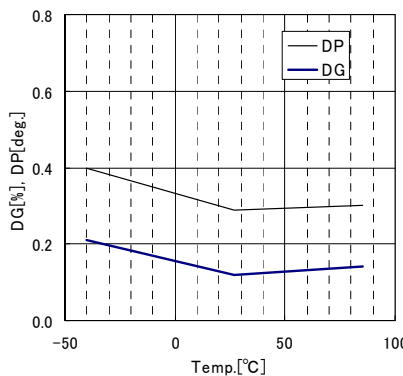

Fig. 26
Differential Gain & Differential Phase vs.
Ambient Temperature

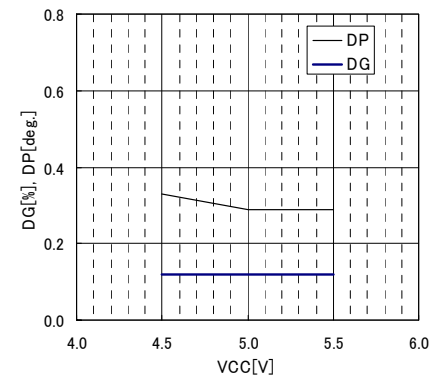

Fig. 27
Differential Gain & Differential Phase vs.
Supply Voltage

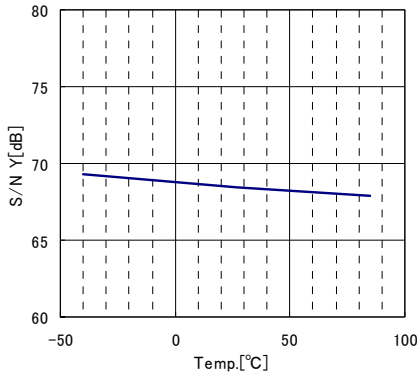

Fig.28
S/N Y vs.
Ambient Temperature

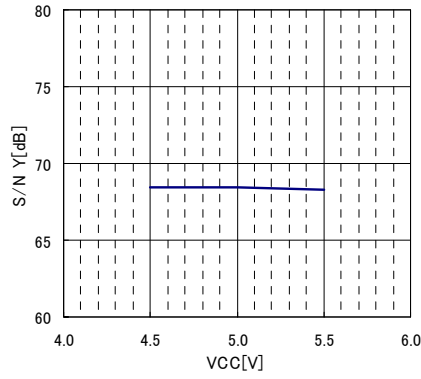

Fig.29
S/N Y vs.
Supply Voltage

•External dimensions and label codes

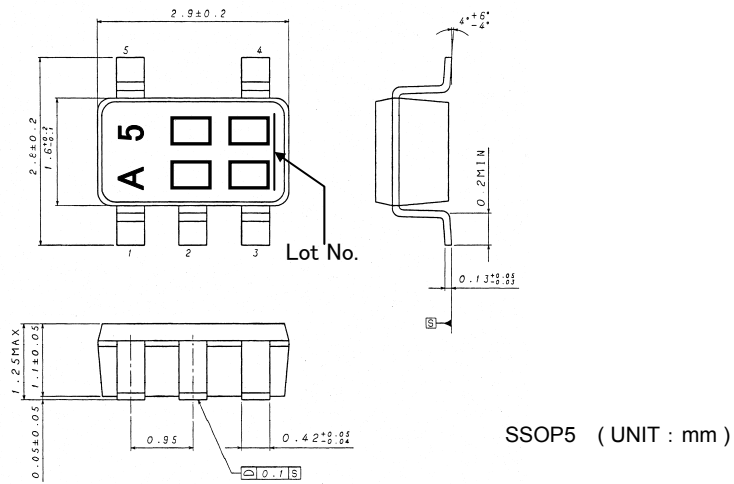
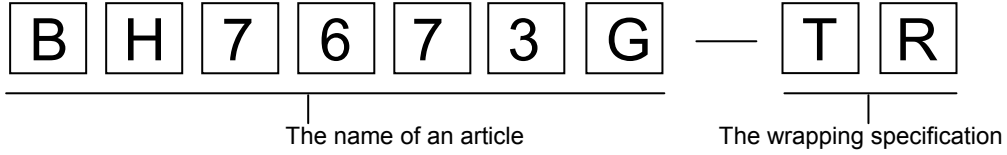
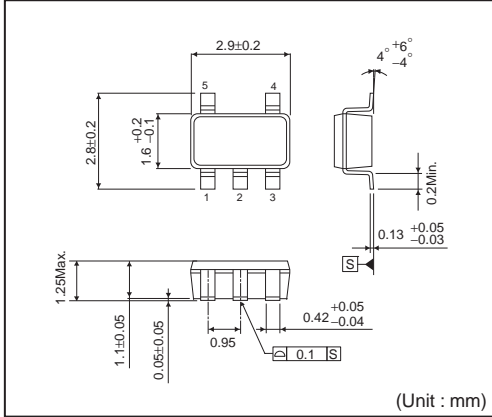

Fig.30 External Dimensions of BH7673G Package

•The ordering -shaped name selection



SSOP5



<Tape and Reel information>

Tape	Embossed carrier tape
Quantity	3000pcs
Direction of feed	TR (The direction is the 1 pin of product is at the upper right when you hold reel on the left hand and you pull out the tape on the right hand)

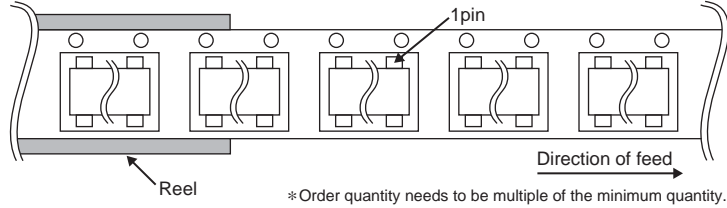

Notice

Precaution on using ROHM Products

- Our Products are designed and manufactured for application in ordinary electronic equipments (such as AV equipment, OA equipment, telecommunication equipment, home electronic appliances, amusement equipment, etc.). If you intend to use our Products in devices requiring extremely high reliability (such as medical equipment ^(Note 1), transport equipment, traffic equipment, aircraft/spacecraft, nuclear power controllers, fuel controllers, car equipment including car accessories, safety devices, etc.) and whose malfunction or failure may cause loss of human life, bodily injury or serious damage to property ("Specific Applications"), please consult with the ROHM sales representative in advance. Unless otherwise agreed in writing by ROHM in advance, ROHM shall not be in any way responsible or liable for any damages, expenses or losses incurred by you or third parties arising from the use of any ROHM's Products for Specific Applications.

(Note1) Medical Equipment Classification of the Specific Applications

JAPAN	USA	EU	CHINA
CLASS III	CLASS III	CLASS II b	CLASS III
CLASS IV		CLASS III	

- ROHM designs and manufactures its Products subject to strict quality control system. However, semiconductor products can fail or malfunction at a certain rate. Please be sure to implement, at your own responsibilities, adequate safety measures including but not limited to fail-safe design against the physical injury, damage to any property, which a failure or malfunction of our Products may cause. The following are examples of safety measures:
 - Installation of protection circuits or other protective devices to improve system safety
 - Installation of redundant circuits to reduce the impact of single or multiple circuit failure
- Our Products are designed and manufactured for use under standard conditions and not under any special or extraordinary environments or conditions, as exemplified below. Accordingly, ROHM shall not be in any way responsible or liable for any damages, expenses or losses arising from the use of any ROHM's Products under any special or extraordinary environments or conditions. If you intend to use our Products under any special or extraordinary environments or conditions (as exemplified below), your independent verification and confirmation of product performance, reliability, etc. prior to use, must be necessary:
 - Use of our Products in any types of liquid, including water, oils, chemicals, and organic solvents
 - Use of our Products outdoors or in places where the Products are exposed to direct sunlight or dust
 - Use of our Products in places where the Products are exposed to sea wind or corrosive gases, including Cl₂, H₂S, NH₃, SO₂, and NO₂
 - Use of our Products in places where the Products are exposed to static electricity or electromagnetic waves
 - Use of our Products in proximity to heat-producing components, plastic cords, or other flammable items
 - Sealing or coating our Products with resin or other coating materials
 - Use of our Products without cleaning residue of flux (even if you use no-clean type fluxes, cleaning residue of flux is recommended); or Washing our Products by using water or water-soluble cleaning agents for cleaning residue after soldering
 - Use of the Products in places subject to dew condensation
- The Products are not subject to radiation-proof design.
- Please verify and confirm characteristics of the final or mounted products in using the Products.
- In particular, if a transient load (a large amount of load applied in a short period of time, such as pulse. is applied, confirmation of performance characteristics after on-board mounting is strongly recommended. Avoid applying power exceeding normal rated power; exceeding the power rating under steady-state loading condition may negatively affect product performance and reliability.
- De-rate Power Dissipation (Pd) depending on Ambient temperature (Ta). When used in sealed area, confirm the actual ambient temperature.
- Confirm that operation temperature is within the specified range described in the product specification.
- ROHM shall not be in any way responsible or liable for failure induced under deviant condition from what is defined in this document.

Precaution for Mounting / Circuit board design

- When a highly active halogenous (chlorine, bromine, etc.) flux is used, the residue of flux may negatively affect product performance and reliability.
- In principle, the reflow soldering method must be used on a surface-mount products, the flow soldering method must be used on a through hole mount products. If the flow soldering method is preferred on a surface-mount products, please consult with the ROHM representative in advance.

For details, please refer to ROHM Mounting specification

Precautions Regarding Application Examples and External Circuits

1. If change is made to the constant of an external circuit, please allow a sufficient margin considering variations of the characteristics of the Products and external components, including transient characteristics, as well as static characteristics.
2. You agree that application notes, reference designs, and associated data and information contained in this document are presented only as guidance for Products use. Therefore, in case you use such information, you are solely responsible for it and you must exercise your own independent verification and judgment in the use of such information contained in this document. ROHM shall not be in any way responsible or liable for any damages, expenses or losses incurred by you or third parties arising from the use of such information.

Precaution for Electrostatic

This Product is electrostatic sensitive product, which may be damaged due to electrostatic discharge. Please take proper caution in your manufacturing process and storage so that voltage exceeding the Products maximum rating will not be applied to Products. Please take special care under dry condition (e.g. Grounding of human body / equipment / solder iron, isolation from charged objects, setting of Ionizer, friction prevention and temperature / humidity control).

Precaution for Storage / Transportation

1. Product performance and soldered connections may deteriorate if the Products are stored in the places where:
 - [a] the Products are exposed to sea winds or corrosive gases, including Cl₂, H₂S, NH₃, SO₂, and NO₂
 - [b] the temperature or humidity exceeds those recommended by ROHM
 - [c] the Products are exposed to direct sunshine or condensation
 - [d] the Products are exposed to high Electrostatic
2. Even under ROHM recommended storage condition, solderability of products out of recommended storage time period may be degraded. It is strongly recommended to confirm solderability before using Products of which storage time is exceeding the recommended storage time period.
3. Store / transport cartons in the correct direction, which is indicated on a carton with a symbol. Otherwise bent leads may occur due to excessive stress applied when dropping of a carton.
4. Use Products within the specified time after opening a humidity barrier bag. Baking is required before using Products of which storage time is exceeding the recommended storage time period.

Precaution for Product Label

QR code printed on ROHM Products label is for ROHM's internal use only.

Precaution for Disposition

When disposing Products please dispose them properly using an authorized industry waste company.

Precaution for Foreign Exchange and Foreign Trade act

Since concerned goods might be fallen under listed items of export control prescribed by Foreign exchange and Foreign trade act, please consult with ROHM in case of export.

Precaution Regarding Intellectual Property Rights

1. All information and data including but not limited to application example contained in this document is for reference only. ROHM does not warrant that foregoing information or data will not infringe any intellectual property rights or any other rights of any third party regarding such information or data.
2. ROHM shall not have any obligations where the claims, actions or demands arising from the combination of the Products with other articles such as components, circuits, systems or external equipment (including software).
3. No license, expressly or implied, is granted hereby under any intellectual property rights or other rights of ROHM or any third parties with respect to the Products or the information contained in this document. Provided, however, that ROHM will not assert its intellectual property rights or other rights against you or your customers to the extent necessary to manufacture or sell products containing the Products, subject to the terms and conditions herein.

Other Precaution

1. This document may not be reprinted or reproduced, in whole or in part, without prior written consent of ROHM.
2. The Products may not be disassembled, converted, modified, reproduced or otherwise changed without prior written consent of ROHM.
3. In no event shall you use in any way whatsoever the Products and the related technical information contained in the Products or this document for any military purposes, including but not limited to, the development of mass-destruction weapons.
4. The proper names of companies or products described in this document are trademarks or registered trademarks of ROHM, its affiliated companies or third parties.

General Precaution

1. Before you use our Products, you are requested to carefully read this document and fully understand its contents. ROHM shall not be in any way responsible or liable for failure, malfunction or accident arising from the use of any ROHM's Products against warning, caution or note contained in this document.
2. All information contained in this document is current as of the issuing date and subject to change without any prior notice. Before purchasing or using ROHM's Products, please confirm the latest information with a ROHM sales representative.
3. The information contained in this document is provided on an "as is" basis and ROHM does not warrant that all information contained in this document is accurate and/or error-free. ROHM shall not be in any way responsible or liable for any damages, expenses or losses incurred by you or third parties resulting from inaccuracy or errors of or concerning such information.

Mouser Electronics

Authorized Distributor

Click to View Pricing, Inventory, Delivery & Lifecycle Information:

[ROHM Semiconductor:](#)

[BH7673G-TR](#)