

DATA SHEET

(PRELIMINARY)

| | |
|----------|-------------|
| Part No. | MN63Y3212N4 |
|----------|-------------|

* The specifications are subject to change without notice since it is under development.

* This is an engineering sample to mainly check functions during development. Reliability and delivery are not guaranteed.

About this manual

■ Organization

These specifications provide important information for users of the MN63Y3212N4, including an overview and descriptions of functions.

■ Manual Configuration

Each section of this manual consists of a title, main text, and notes. The layout and definition of each section are shown below.

1.1 UART

This section describes the UART specification.

1.1.1 Communication Specifications

Table 1-1 shows the UART specification of this RFID.

Table 1-1 UART Communication Specification

| | |
|------------------------|---|
| Data transfer method | Asynchronous, half duplex (Only IRQ notification allows full duplex) |
| Data rate | 1200 bps, 2400 bps, 4800 bps, 9600 bps, 19200 bps, 38400 bps |
| Character transmission | <ul style="list-style-type: none"> · LSB-first · Data (8 bits) · Start bit(1bit) · Parity bit(1bit, even) · Stop bit(1bit) See Note below. |
| Other | No flow control signal (RTS/CTS) |

Note: In order to ensure the timing margin, when sending consecutive data from the host, use a 2-bit stop bit or set the interval between stop bit and next start bit to 1 bit or more.

Middle title

Small title

Text

Note

This is the Note.
Please read.

■ Finding Desired Information

This manual provides two methods for finding desired information quickly and easily.

1. Consult the table of contents at the front of the manual to locate desired titles.
2. Chapter names are located at the top outer corner of each page, and section titles are located at the bottom outer corner of each page.

Chapter 1 Overview

Chapter 2 Pin Descriptions

Chapter 3 Memory Map

Chapter 4 RF Communication Mode

Chapter 5 Interrupt Generation Function

Chapter 6 Electrical Characteristics

1

2

3

4

5

6

Contents

| | |
|---|-----------|
| Chapter 1 Overview | 9 |
| 1.1 Features..... | 10 |
| 1.2 Block Diagram..... | 11 |
| 1.3 Operation Mode..... | 12 |
| 1.4 Encrypted Communication Function..... | 13 |
| Chapter 2 Pin Descriptions | 15 |
| 2.1 Module outline..... | 16 |
| 2.2 Pin Descriptions..... | 17 |
| 2.3 Connection Example..... | 18 |
| Chapter 3 Memory Map..... | 19 |
| 3.1 Block Configuration | 20 |
| 3.2 Physical Memory Map..... | 21 |
| 3.3 System Area..... | 22 |
| 3.3.1 Parameter Specifications | 22 |
| 3.3.2 Enabling System Area | 26 |
| 3.4 Address Correspondence | 27 |
| Chapter 4 RF Communication Mode | 29 |
| 4.1 RF Communication Mode Sequence..... | 30 |
| 4.2 JISX6319-4 Specification..... | 31 |
| 4.2.1 Communication Specifications..... | 31 |
| 4.2.2 Frame Format | 31 |
| 4.2.3 State Transition Diagram..... | 32 |
| 4.2.4 Flow Chart..... | 32 |
| 4.2.5 Various Settings | 33 |
| 4.2.5.1 System Code | 33 |
| 4.2.5.2 PICC (Proximity IC Card) Identifier | 33 |
| 4.2.5.3 Response Time Descriptor..... | 34 |
| 4.2.5.4 Anticollision..... | 34 |
| 4.2.5.5 Service..... | 35 |
| 4.2.5.6 Block..... | 35 |
| 4.2.5.7 Block List..... | 36 |
| 4.2.5.8 Status Flag..... | 38 |
| 4.2.6 Command | 39 |
| 4.2.6.1 REQ..... | 40 |
| 4.2.6.2 READ..... | 41 |
| 4.2.6.3 WRITE..... | 43 |
| 4.2.7 NDEF..... | 44 |

| | |
|--|-----------|
| 4.2.7.1 MEMORY MAP | 44 |
| 4.2.7.2 Setup of System Code (SC) | 45 |
| 4.2.7.3 Setup of Attribute Information Block | 45 |
| 4.2.7.4 NDEF FILE | 46 |
| 4.3 ISO/IEC14443 TypeB Specification | 47 |
| 4.3.1 Communication Specification | 47 |
| 4.3.2 Frame Format | 47 |
| 4.3.3 Protocol Control | 48 |
| 4.3.4 Block Control | 49 |
| 4.3.5 Upper Command Format | 50 |
| 4.3.6 State Transition Diagram | 52 |
| 4.3.7 Flow Chart | 53 |
| 4.3.8 Various Settings | 54 |
| 4.3.8.1 AFI (Application Family Identifier) | 54 |
| 4.3.8.2 PUPI (Pseudo-Unique PICC Identifier) | 54 |
| 4.3.8.3 FWI (Frame Waiting Time Integer) | 55 |
| 4.3.8.4 File System | 55 |
| 4.3.8.5 Address | 56 |
| 4.3.8.6 Data | 57 |
| 4.3.8.7 Status Word | 58 |
| 4.3.9 Command | 59 |
| 4.3.9.1 REQB/WUPB | 60 |
| 4.3.9.2 ATTRIB | 62 |
| 4.3.9.3 HLTB | 64 |
| 4.3.9.4 SELECT | 65 |
| 4.3.9.5 READ | 67 |
| 4.3.9.6 WRITE | 68 |
| 4.3.10 NDEF | 69 |
| 4.3.10.1 Memory Map | 69 |
| 4.3.10.2 NDEF Tag Application Selection | 70 |
| 4.3.10.3 CC File | 70 |
| 4.3.10.4 NDEF File | 71 |
| Chapter 5 Interrupt Generation Function | 73 |
| 5.1 Interrupt Source | 74 |
| Chapter 6 Electrical characteristics | 75 |

Chapter 1 Overview



1.1 Features

The MN63Y3212N4 is a Tag Module for RFID (Radio Frequency Identification), which features the following:

- Built-in 4-Kbit non-volatile memory with fast write and low power consumption.
- RF interface compliant with JISX6319-4 (212 kbps / 424 kbps) and ISO/IEC14443 TypeB (106 kbps / 212 kbps) of the 13.56-MHz contactless IC card standards.
- Batteryless RF communication
- Encryption communication function that uses AES (128 bits) private-key cryptosystem
- Supply voltage range: 1.7 V to 3.6 V

1.2 Block Diagram

Figure 1-1 shows a block diagram.

This RFID provides RF interface for contactless communication with external reader/writer, serial interface for contact communication with external host, control logic for command processing and various controls, 2-Kbit transmit/receive buffer for RF communication, 4-Kbit non-volatile memory, and AES cryptosystem.

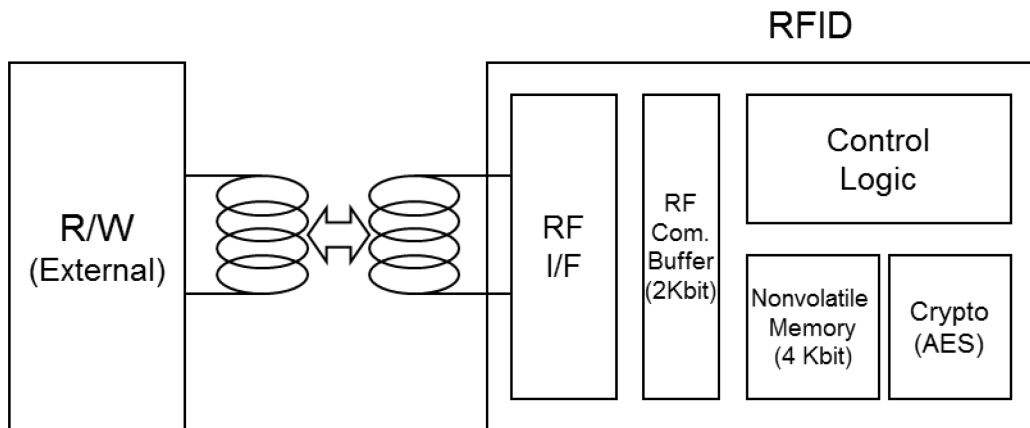

Figure 1-1 Block Diagram

1.3 Operation Mode

This RFID provides the one operation modes of RF communication.

Figure 1-2 gives the overview of each operation mode.

■ RF communication mode

This mode is used for communication between reader/writer and RFID. Reader/writer is the master and RFID is the slave. Key commands are read and write commands to non-volatile memory of RFID. This mode allows batteryless operations that use only the power supplied from the antenna of reader/writer.

For more information about RF communication mode, see Chapter 4 RF Communication Mode.

RF communication mode

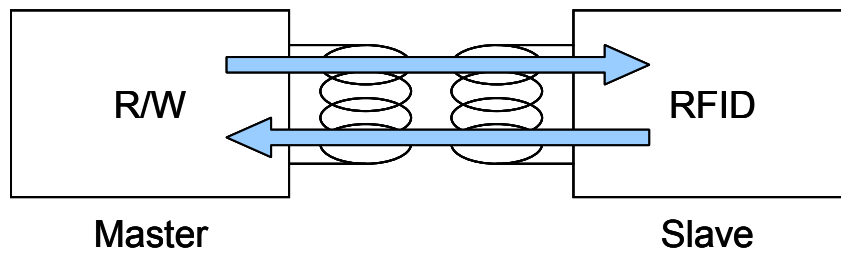

Figure 1-2 Operation Mode

1.4 Encrypted Communication Function

This RFID provides an encrypted communication function.

Figure 1-3 depicts its functionality in the one operation mode.

For communication between reader/writer and RFID, RF communication mode allows both encrypted and plaintext (unencrypted) communications

Encrypted communication uses Message Authentication Code (MAC) to detect falsified communication data and to prevent access from illegal readers/writers.

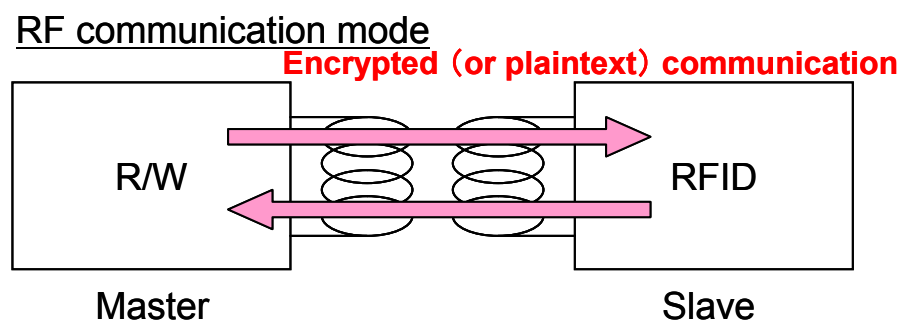

Figure 1-3 Encrypted Communication Function

Chapter 2 Pin Descriptions

2.1 Module outline

Figure 2-1 shows module outline of this RFID

1) External dimensions

D1 : $30\pm 0.5\text{mm}$ (Coin-tag : Body)

2) Thickness

T : $3.0\pm 0.5\text{mm}$

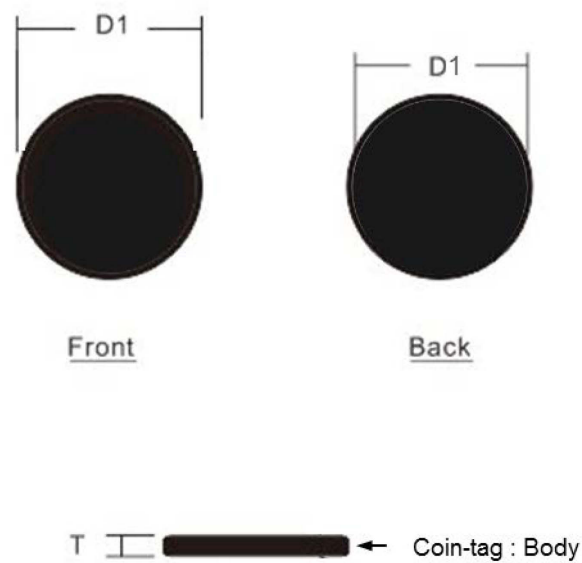

Figure 2-1 Module outline

2.2 Pin Descriptions

Main pins of the LSI mounted on the module are described below.

■ Coil connection pins (VA,VB)

Used for connecting an antenna coil. Also connect a resonance capacitor for adjusting resonance frequency.

2.3 Connection Example

Figure 2-2 gives a connection example of the antenna and the mounting LSI in module.

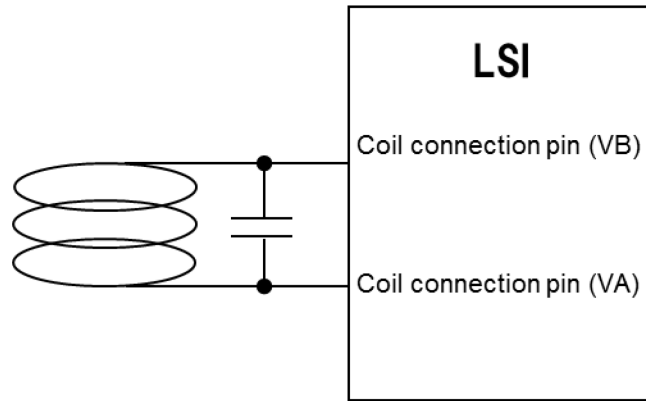

Figure 2-2 Connection Example

Chapter 3 Memory Map

3.1 Block Configuration

Figure 3-1 illustrates the block configuration of 4-Kbit non-volatile memory.

This LSI consists of 32 non-volatile memory blocks. The size of a block is 16 bytes.

The memory consists of two areas: user and system areas.

The system area stores RF-communication-related parameters and memory-access-control-related data, etc.

| Block | Area | Type |
|-------|-----------------------------|-------------|
| 0 | 16-byte non-volatile memory | User area |
| 1 | 16-byte non-volatile memory | |
| 2 | 16-byte non-volatile memory | |
| 3 | 16-byte non-volatile memory | |
| ... | ... | |
| 24 | 16-byte non-volatile memory | |
| 25 | 16-byte non-volatile memory | |
| 26 | 16-byte non-volatile memory | |
| 27 | 16-byte non-volatile memory | |
| 28 | 16-byte non-volatile memory | |
| 29 | 16-byte non-volatile memory | System area |
| 30 | 16-byte non-volatile memory | |
| 31 | 16-byte non-volatile memory | |

Figure 3-1 4-Kbit non-volatile memory Block Configuration

3.2 Physical Memory Map

Figure 3-2 presents the physical memory map.

| Block | Address | 0x0 | 0x1 | 0x2 | 0x3 | 0x4 | 0x5 | 0x6 | 0x7 | 0x8 | 0x9 | 0xA | 0xB | 0xC | 0xD | 0xE | 0xF |
|-------|---------|-----------|-----|-----|-----|------|-----|-----|-----|----------|-----|-----|-----|-------|-----|--------|-----|
| 0 | 0x0000 | User Area | | | | | | | | | | | | | | | |
| 1 | 0x0010 | User Area | | | | | | | | | | | | | | | |
| 2 | 0x0020 | User Area | | | | | | | | | | | | | | | |
| 3 | 0x0030 | User Area | | | | | | | | | | | | | | | |
| 4 | 0x0040 | User Area | | | | | | | | | | | | | | | |
| 5 | 0x0050 | User Area | | | | | | | | | | | | | | | |
| 6 | 0x0060 | User Area | | | | | | | | | | | | | | | |
| 7 | 0x0070 | User Area | | | | | | | | | | | | | | | |
| 8 | 0x0080 | User Area | | | | | | | | | | | | | | | |
| 9 | 0x0090 | User Area | | | | | | | | | | | | | | | |
| 10 | 0x00A0 | User Area | | | | | | | | | | | | | | | |
| 11 | 0x00B0 | User Area | | | | | | | | | | | | | | | |
| 12 | 0x00C0 | User Area | | | | | | | | | | | | | | | |
| 13 | 0x00D0 | User Area | | | | | | | | | | | | | | | |
| 14 | 0x00E0 | User Area | | | | | | | | | | | | | | | |
| 15 | 0x00F0 | User Area | | | | | | | | | | | | | | | |
| 16 | 0x0100 | User Area | | | | | | | | | | | | | | | |
| 17 | 0x0110 | User Area | | | | | | | | | | | | | | | |
| 18 | 0x0120 | User Area | | | | | | | | | | | | | | | |
| 19 | 0x0130 | User Area | | | | | | | | | | | | | | | |
| 20 | 0x0140 | User Area | | | | | | | | | | | | | | | |
| 21 | 0x0150 | User Area | | | | | | | | | | | | | | | |
| 22 | 0x0160 | User Area | | | | | | | | | | | | | | | |
| 23 | 0x0170 | User Area | | | | | | | | | | | | | | | |
| 24 | 0x0180 | User Area | | | | | | | | | | | | | | | |
| 25 | 0x0190 | User Area | | | | | | | | | | | | | | | |
| 26 | 0x01A0 | User Area | | | | | | | | | | | | | | | |
| 27 | 0x01B0 | CONFIG | | | | | | | | | | | | | | | |
| 28 | 0x01C0 | CONFIG | | | | | | | | | | | | | | | |
| 29 | 0x01D0 | CONFIG | | | | | | | | | | | | | | | |
| 30 | 0x01E0 | SC | IDM | | | | | | PMM | AFI | FWI | HW1 | | | | | |
| 31 | 0x01F0 | RORF | | | | ROSI | | | | SECURITY | | | | TNPRM | HW2 | CONFIG | |

Figure 3-2 Physical Memory Map

3.3 System Area

This section describes the system area.

3.3.1 Parameter Specifications

Each parameter of the system area is shown below.

All addresses and block numbers used in this section correspond to the physical address in Figure 3-2.

■ RORF (4 bytes)

RORF and SECURITY are an area to specify whether read/write or read-only is to be used in accessing the block by memory access commands in RF communication mode. Table 3-1 describes RORF and SECURITY setting, and Table 3-2 shows RORF setting bits and corresponding block numbers. By default, all values are 0. Set all reserved bits to 0. Refer to Table 3-5 for SECURITY

Table 3-1 RORF and SECURITY Setting

| Value | | Meaning - | |
|-------|----------|-------------------------|--------------------------|
| RORF | SECURITY | Plaintext communication | Encryption communication |
| 0 | 0 | READ/WRITE | READ/WRITE |
| 0 | 1 | Prohibition | READ/WRITE |
| 1 | 0 | READ ONLY | READ ONLY |
| 1 | 1 | READ ONLY | READ/WRITE |

Table 3-2 RORF Setting Bits and Corresponding Block Numbers

| Address | Bit 7 | Bit 6 | Bit 5 | Bit 4 | Bit 3 | Bit 2 | Bit 1 | Bit 0 |
|---------|----------|----------|----------|----------|----------|---------|---------|---------|
| 0x01F0 | Block7 | Block6 | Block5 | Block4 | Block3 | Block2 | Block1 | Block0 |
| 0x01F1 | Block15 | Block14 | Block13 | Block12 | Block11 | Block10 | Block9 | Block8 |
| 0x01F2 | Block23 | Block22 | Block21 | Block20 | Block19 | Block18 | Block17 | Block16 |
| 0x01F3 | Reserved | Reserved | Reserved | Reserved | Reserved | Block26 | Block25 | Block24 |

■ ROSI (4 bytes)

ROSI is reserved Set all bits to 0.

■ SECURITY (4 bytes)

RORF and SECURITY are an area to specify whether to enable plaintext (unencrypted) communication access by memory access commands in RF communication mode. This setting is valid only in RF communication mode. Table 3-31 describes RORF and SECURITY setting, and Table 3-33 shows SECURITY setting bits and corresponding block numbers. By default, all values are 0. Set all reserved bits to 0.

Table 3-3 SECURITY Setting Bit and Corresponding Block Number

| Address | Bit 7 | Bit 6 | Bit 5 | Bit 4 | Bit 3 | Bit 2 | Bit 1 | Bit 0 |
|---------|----------|----------|----------|----------|----------|---------|---------|---------|
| 0x01F8 | Block7 | Block6 | Block5 | Block4 | Block3 | Block2 | Block1 | Block0 |
| 0x01F9 | Block15 | Block14 | Block13 | Block12 | Block11 | Block10 | Block9 | Block8 |
| 0x01FA | Block23 | Block22 | Block21 | Block20 | Block19 | Block18 | Block17 | Block16 |
| 0x01FB | Reserved | Reserved | Reserved | Reserved | Reserved | Block26 | Block25 | Block24 |

■ HW1 (2 bytes)

HW1 is an area to store various setting data related to the hardware of this RFID.

Table 3-4 describes the HW1 parameter. For the setting of the RF communication protocol RFTYPE, see Table 3-5. For the setting of IDM data selection IDMSSEL, see Table 3-6.

Table 3-4 HW1 Parameter

| Address | Bit 7 | Bit 6 | Bit 5 | Bit 4 | Bit 3 | Bit 2 | Bit 1 | Bit 0 |
|---------|----------|-----------------------------|--------|-------|----------|-------|-------|---------|
| 0x01EE | Reserved | | RFTYPE | | Reserved | | | IDMSSEL |
| 0x01EF | Reserved | Reserved(Please set "0x54") | | | | | | |

Table 3-5 RFTYPE Setting for Selecting RF Communication Protocol

| Bit 5 | Bit 4 | Meaning |
|-------|-------|--|
| 0 | 0 | Use both JISX6319-4 and ISO/IEC14443 TypeB. (Automatic protocol detection) (default) |
| 0 | 1 | Use JISX6319-4 only. (ISO/IEC14443 TypeB interface disabled) |
| 1 | 0 | Use ISO/IEC14443 TypeB only. (JISX6319-4 interface disabled) |
| 1 | 1 | Reserved (When this field is specified, a default setting will be applied.) |

Table 3-6 IDMSSEL Setting for Selecting IDM Data

| Bit 0 | Meaning |
|-------|--|
| 0 | Use the fixed values (All-0) as JISX6319-4 PICC identifier or ISO/IEC14443 TypeB PICC. Values written in the system area are not used. (default) |
| 1 | Use the values written in the system area as JISX6319-4 PICC identifier or ISO/IEC14443 TypeB PICC. |

■ TNPRM (1 byte)

TNPRM is reserved.

Table 3-7 TNPRM Parameter

| Address | Bit 7 | Bit 6 | Bit 5 | Bit 4 | Bit 3 | Bit 2 | Bit 1 | Bit 0 |
|---------|----------------------------|-------|-------|-------|-----------------------------|-------|-------|-------|
| 0x01FC | Reserved(Please set "0x4") | | | | Reserved (Please set "0x7") | | | |

■ HW2 (1 byte)

HW2 is reserved.

Table 3-8 HW2 Parameter

| Address | Bit 7 | Bit 6 | Bit 5 | Bit 4 | Bit 3 | Bit 2 | Bit 1 | Bit 0 |
|---------|--------------------------------|-------|--------------------------------|-------|----------|--------|-------|-------|
| 0x01FD | Reserved (Please set "0x3") | | Reserved (Please set "0x3") | | Reserved | IRQSEL | | |

■ IRQSEL

IRQSEL is used for IRQ notification to add the condition of generating an interrupt to the NIRQ pin.

There are two user-selectable additional interrupt sources, RF communication detection or reader/writer magnetic-field detection. In addition, RF communication can be detected when RF response transmission is completed or when a write to non-volatile memory with the RF command is completed (selectable).

For more information about interrupt source, see Section 5 Interrupt Generation Function

The IRQSEL settings are as follows.

Table 3-9 IRQSEL Setting for IRQ Notification

| Bit 2 | Bit 1 | Bit 0 | Meaning |
|-------|-------|-------|--|
| 0 | 0 | X | Do not generate an interrupt when RF response transmission is completed or when a write to non-volatile memory with the RF command is completed. |
| 0 | 1 | X | Reserved |
| 1 | 0 | X | Generate an interrupt when RF response transmission is completed. |
| 1 | 1 | X | Generate an interrupt when a write to non-volatile memory with the RF command is completed. |
| X | X | 0 | Do not generate an interrupt when a magnetic field is detected. |
| X | X | 1 | Generate an interrupt when a magnetic field is detected. |

■ SC (2 bytes)

SC is used as the JISX6319-4 system code (2 bytes). For more information about system code, see Section 4.2.5.1 System Code.

Table 3-10 SC Parameter

| Address | 0x01E0 | 0x01E1 |
|----------------------------------|--------|--------|
| JISX6319-4 system code (2 bytes) | D0 | D1 |
| Default | 0xAA | 0xFF |

■ IDM (8 bytes)

IDM is used as JISX6319-4 PICC (Proximity IC Card) identifier (8 bytes). The PUPI (Pseudo-Unique PICC Identifier) (4 bytes) of ISO/IEC14443 TypeB is shared with the lower 4 bytes of the JISX6319-4 PICC identifier. For information about JISX6319-4 PICC identifier, see Section 4.2.5.2 PICC (Proximity IC Card) Identifier, and for information about ISO/IEC14443 TypeB PUPI, see Section 4.3.8.2 PUPI.

Table 3-11 IDM Parameter

| Address | 0x01E2 | 0x01E3 | 0x01E4 | 0x01E5 | 0x01E6 | 0x1E7 | 0x1E8 | 0x01E9 |
|---|----------|--------|--------|--------|--------|-------|-------|--------|
| JISX6319-4 PICC identifier (8 bytes) | D0 | D1 | D2 | D3 | D4 | D5 | D6 | D7 |
| Default | 0x02 | 0xFE | 0x00 | 0x00 | 0x00 | 0x00 | 0x00 | 0x00 |
| ISO/IEC14443TypeB PUPI (4 bytes) | Reserved | | | | D0 | D1 | D2 | D3 |
| Default | - | - | - | - | 0x00 | 0x00 | 0x00 | 0x00 |

Note: In order to validate the value written in the system area IDM, the HW parameter's IDMSEL must be set to 1. See Table 3-6

■ PMM (2 bytes)

Of the JISX6319-4 response time descriptor (8 bytes), PMM is an area (2 bytes) to specify maximum wait time for the response to READ/WRITE commands. See Section 4.2.5.3

Table 3-12 PMM Parameter

| Address | 0x01EA | 0x01EB |
|--|--------|--------|
| JISX6319-4 Response time descriptor (2 bytes) | D5 | D6 |
| Default | 0xFF | 0xFF |

■ AFI (1 byte)

AFI is an area to specify AFI (Application Family Identifier) of ISO/IEC14443 TypeB. See Section 4.3.8.1 AFI.

Table 3-13 AFI Parameter

| Address | 0x01EC |
|------------------------------------|--------|
| ISO/IEC14443 TypeB AFI (1 byte) | D0 |
| Default | 0x00 |

■ FWI (1 byte)

FWI is an area to specify FWI (Frame Waiting time Integer) of ISO/IEC14443 TypeB. See Section 4.3.8.3 FWI.

Table 3-14 FWI Parameter

| Address | 0x01ED |
|------------------------------------|--------|
| ISO/IEC14443 TypeB FWI (1 byte) | D0 |
| Default | 0xE0 |

■ CONFIG

See the Administrator's Manual.

3.3.2 Enabling System Area

In order to enable parameters in the system area, CFEN and BCC (see the Administrator's Manual) of the system area must be set to valid values. If CFEN and BCC are not set to valid values, default values defined by each parameter will be applied.

Table 3-15 lists the setting application timings after rewriting parameters in the system area while CFEN and BCC are enabled. New parameter setting is applied to RORF, ROSI, and SECURITY immediately after rewriting, and applied to other parameters after turning power supply ON from OFF.

Table 3-15 Parameter Application Timing

| | A timing at which new parameter setting is applied after rewriting parameters when CFEN is enabled. |
|----------|---|
| RORF | Apply immediately after rewrites. |
| ROSI | Apply immediately after rewrites. |
| SECURITY | Apply immediately after rewrites. |
| HW1 | Apply after turning power ON from OFF following rewrites. |
| TNPRM | Apply after turning power ON from OFF following rewrites. |
| HW2 | Apply after turning power ON from OFF following rewrites. |
| SC | Apply after turning power ON from OFF following rewrites. |
| IDM | Apply after turning power ON from OFF following rewrites. |
| PMM | Apply after turning power ON from OFF following rewrites. |
| AFI | Apply after turning power ON from OFF following rewrites. |
| FWI | Apply after turning power ON from OFF following rewrites. |
| CONFIG | See the Administrator's Manual. |

Note: Power OFF means power supplies from RF interface are OFF.

3.4 Address Correspondence

Figure 3-3 presents the physical address and the corresponding address of each communication mode.

| Physical address | | RF communication mode | | |
|------------------|--------|-----------------------|-----|--------------|
| | | JISX6319-4 | | ISO/IEC14443 |
| Block0 | 0x0000 | Block No. 0 | D0 | 0x0000 |
| | 0x0001 | | D1 | 0x0001 |
| | 0x0002 | | D2 | 0x0002 |
| | 0x0003 | | D3 | 0x0003 |
| | 0x0004 | | D4 | 0x0004 |
| | 0x0005 | | D5 | 0x0005 |
| | 0x0006 | | D6 | 0x0006 |
| | 0x0007 | | D7 | 0x0007 |
| | 0x0008 | | D8 | 0x0008 |
| | 0x0009 | | D9 | 0x0009 |
| | 0x000A | | Da | 0x000A |
| | 0x000B | | Db | 0x000B |
| | 0x000C | | Dc | 0x000C |
| | 0x000D | | Dd | 0x000D |
| | 0x000E | | De | 0x000E |
| | 0x000F | | Df | 0x000F |
| Block1 | 0x0010 | Block No. 1 | D0 | 0x0010 |
| | 0x0011 | | D1 | 0x0011 |
| | ... | | ... | ... |
| | 0x001E | | De | 0x001E |
| | 0x001F | | Df | 0x001F |
| ... | | | | |
| Block31 | 0x01F0 | Block No. 31 | D0 | 0x01F0 |
| | 0x01F1 | | D1 | 0x01F1 |
| | ... | | ... | ... |
| | 0x01FE | | De | 0x01FE |
| | 0x01FF | | Df | 0x01FF |

Figure 3-3 Address Correspondence

Chapter 4 RF Communication Mode

4.1 RF Communication Mode Sequence

Figure 4-1 illustrates the sequence in RF communication mode. Each sequence is described below.

SNo.1: A reader/writer sends an RF communication mode command to the RFID.

SNo.2: Once the RFID receives the RF communication mode command described in SNo.1, it processes the command and then sends the result to the reader/writer as the response to the command.

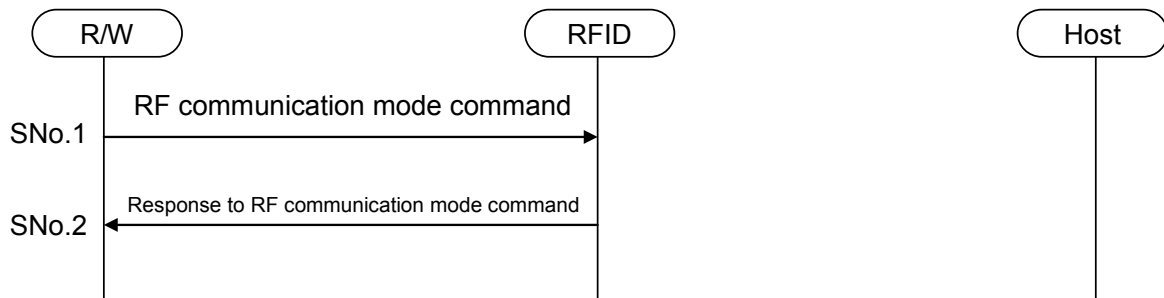

Figure 4-1 RF Communication Mode Sequence

4.2 JISX6319-4 Specification

This section describes the JISX6319-4 specification of this RFID.

4.2.1 Communication Specifications

Table 4-1 shows the JISX6319-4 specification of this RFID.

Table 4-1 JISX6319-4 Communication Specification

| | | |
|----------------------------------|----------|--|
| Carrier frequency | | 13.56 MHz |
| Modulation mode, Bit encoding | R/W→RFID | ASK10%, Manchester encoding |
| | RFID→R/W | Load modulation, Manchester encoding |
| Data rate | | 212 kbps / 424 kbps |
| Character transmission | | <ul style="list-style-type: none"> · MSB-first · Data (8 bits) · No start bit · No parity bit · No stop bit · No spare time between characters |

4.2.2 Frame Format

Figure 4-2 illustrates the JISX6319-4 frame format and Table 4-2 defines the fields.

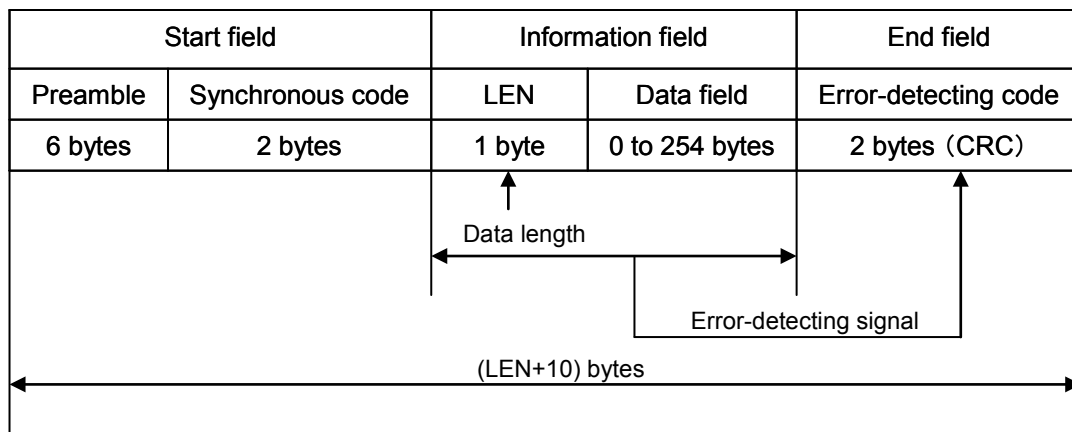

Figure 4-2 JISX6319-4 Frame Format

Table 4-2 JISX6319-4 Field Definition

| Field name | Byte length | Definition |
|----------------------|-------------|--|
| Preamble | 6 | 0x000000000000 |
| Synchronous code | 2 | 0xB24D |
| LEN | 1 | n (data field length) + 1 |
| Data field | n | Command message or Response message |
| Error-detecting code | 2 | Initial value: 0000, CRC (Generating polynomial: $X^{16}+X^{12}+X^5+1$) |

4.2.3 State Transition Diagram

Figure 4-3 shows the state transition diagram for the JIX6319-4 PICC of this RFID.

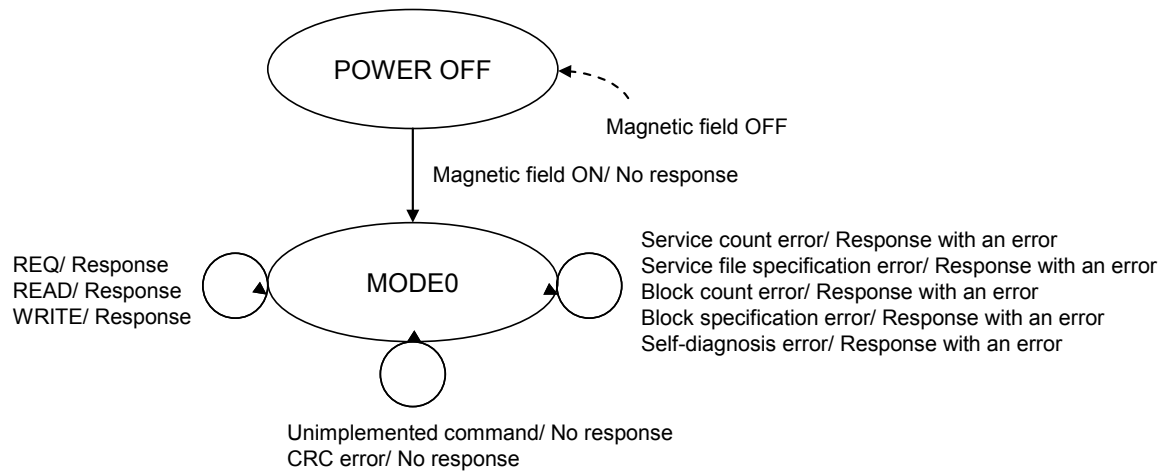

Figure 4-3 State Transition Diagram of JISX6319-4 PICC

4.2.4 Flow Chart

Figure 4-4 gives the flow chart for JIX6319-4 command processing of this RFID.

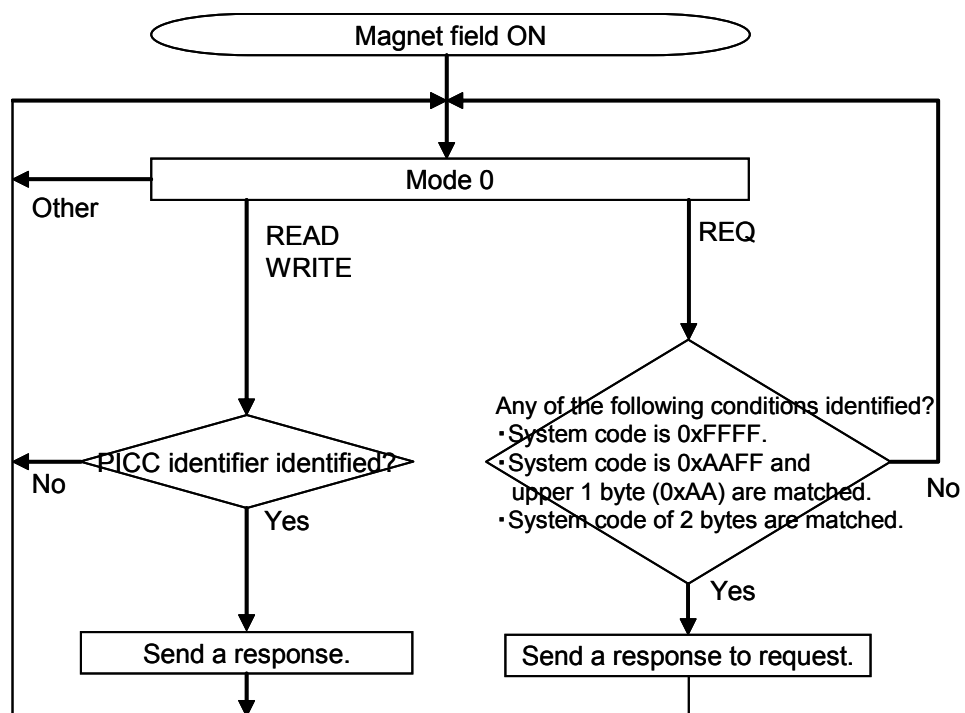

Figure 4-4 JISX6319-4 Flow Chart of Command Processing

4.2.5 Various Settings

This section describes the parameter settings and operation specifications based on JISX6319-4 for this RFID.

4.2.5.1 System Code

System code is a parameter specified by the REQ command that is used to identify the RFID. Figure 4-5 shows the system code. The system code is set by the value of the system area SC for non-volatile memory. The response operation to the REQ command by system code is shown in Table 4-3.

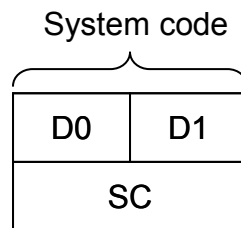

Figure 4-5 System Code

Table 4-3 Response to REQ Command by System Code

| REQ command System code setting value | RFID's response to REQ command |
|--|--|
| 0xFFFF | Responds regardless of the system area SC setting |
| 0xA AFF | When the value of the upper 1 byte of the SC system area is 0xAA, the RFID responds regardless of the value of the lower 1 byte. |
| Other | Responds only when the setting value of the REQ command's system code matches the value specified in the system area SC (and does not respond in other cases). |

4.2.5.2 PICC (Proximity IC Card) Identifier

The PICC (Proximity IC Card) identifier is a data used to identify RFID, and is included in the response to the REQ command. Figure 4-6 illustrates the PICC identifier's format. The PICC identifier (8 bytes) is set in the system area IDM.

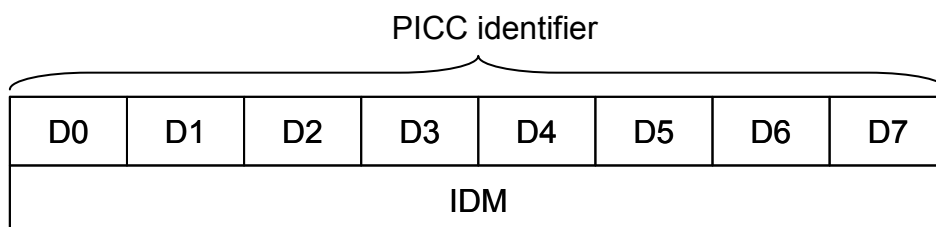

Figure 4-6 PICC Identifier Format

4.2.5.3 Response Time Descriptor

The response time descriptor is used to specify the maximum wait time until the RFID sends a response after reader/writer sends a command, and is included in the response to the REQ command. Figure 4-7 illustrates the response time descriptor's format. In hardware, D0, D1, and D7 bytes are set to FFh and D2 to D4 bytes are set to 00h. The response time calculation parameters D5 and D6 bytes are the values of the system area. Table 4-4 shows the response time calculation parameter and corresponding command.

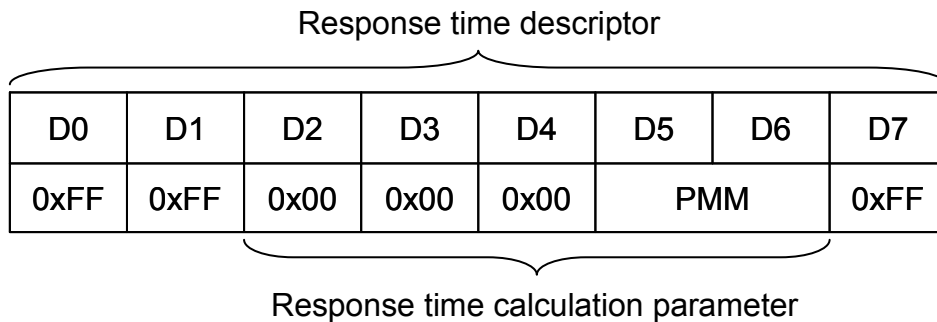

Figure 4-7 Response Time Descriptor Format

Table 4-4 Response Time Calculation Parameter and Corresponding Command

| Response time calculation parameter | Command |
|-------------------------------------|---------|
| D5 | READ |
| D6 | WRITE |

Figure 4-8 shows the response time calculation parameter's format.

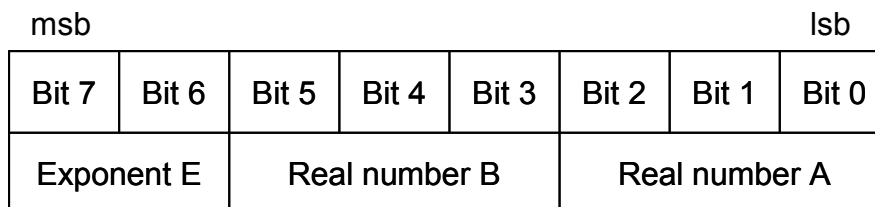

Figure 4-8 Response Time Calculation Parameter Format

The response time is calculated by the following formula:

$$\text{Response time} = T \times [(B + 1) \times n + (A + 1)] \times 4^E$$

T: $256 \times 16/f_c$ (approx. 0.302 ms)

n: No. of blocks or No. of files of command parameter.

4.2.5.4 Anticollision

JISX6319-4 uses the time slot method for anti-collision (prevention of collision). This RFID always responds according to the first slot.

4.2.5.5 Service

This RFID does not implement the concept of service based on JISX6319-4.

However, it is possible to specify multiple services using a command service list. Table 4-5 shows the available maximum number of services. When specifying multiple services in the service list, the values of service list must be set to the same value.

Table 4-5 Maximum Number of Services

| Command | Maximum No. of services |
|---------|-------------------------|
| READ | 15 |
| WRITE | 11 |

Note: The RFID responds with an error when multiple services are not set to the same service file value.

4.2.5.6 Block

JISX6319-4 uses data of 16-byte blocks. Block number is used to specify each block. Figure 4-9 shows the block element of 2 bytes and Figure 4-10 shows the block element of 3 bytes. All of bits 6 to 4 of byte D0 for access mode setting should be set to 0 in this RFID; otherwise the RFID responds with an error.

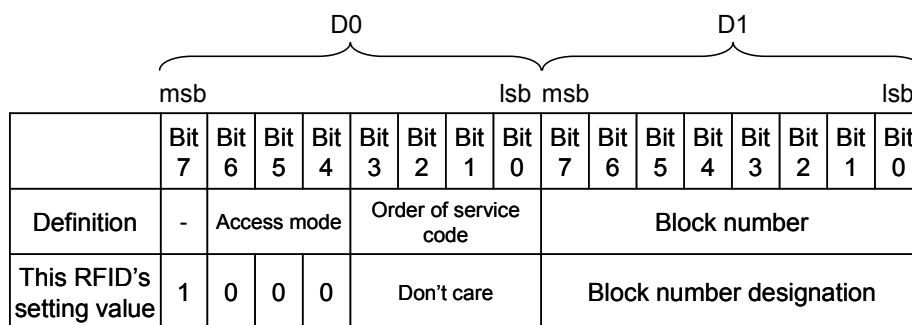

Figure 4-9 Block Element of 2 Bytes

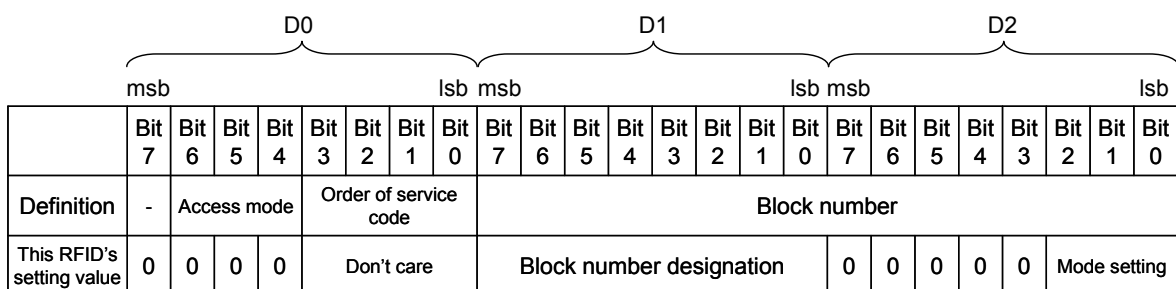

Figure 4-10 Block Element of 3 Bytes

This RFID uses a block number to specify encrypted communication. Table 4-6 shows the mode settings for encrypted communication. Bits 2 to 0 of byte D2 in 3-byte block element format are used. All of bits 7 to 3 of byte D2 should be set to 0; otherwise the RFID responds with an error.

Table 4-6 Mode Settings

| Block element format | Byte D2 of block No. | | | Meaning | |
|----------------------|----------------------|-------|-------|--|---------------------------------------|
| | Bit 2 | Bit 1 | Bit 0 | Communication mode | Encrypted communication |
| 2 bytes | - | - | - | RF communication mode | Plaintext (unencrypted) communication |
| 3 bytes | 0 | 0 | 0 | | Encrypted communication (private key) |
| | 0 | 1 | 0 | | Encrypted communication (family key) |
| | 0 | 1 | 1 | Reserved (Setting this field causes an error.) | |
| | 0 | 0 | 1 | Reserved (Setting this field causes an error.) | |
| | 1 | 0 | 0 | | |
| | 1 | 1 | 0 | | |
| 1 | 1 | 1 | | | |
| | 1 | 0 | 1 | | |

Table 4-7 shows the available maximum number of blocks. For READ command, the number is 13 for plaintext (unencrypted) communication in RF communication mode. The maximum number of blocks for WRITE command depends on the number of services.

Table 4-7 Maximum Number of Blocks

| Command | Communication mode | Encrypted communication | No. of services | Maximum No. of blocks |
|---------|-----------------------|--|-----------------|-----------------------|
| READ | RF communication mode | Plaintext (unencrypted) communication | 1 to 15 | 15 |
| | | Encrypted communication | 1 to 15 | 15 |
| WRITE | RF communication mode | Plaintext (unencrypted) communication, Encrypted communication | 1 to 8 | 12 |
| | | | 9 to 11 | 11 |

Note: Encrypted communication uses 2 blocks for its parameter, so the available number of blocks for data is "the value listed in Table 4-7 – 2."

4.2.5.7 Block List

For encrypted communication how to specify block list is slightly different from the JISX6319-4 specification. Figure 4-11 shows the block list referenced from this RFID.

- (1) Plaintext (unencrypted) communication in RF communication mode: The block number of block list can be set freely. The RFID references to all block numbers.
- (2) Encrypted communication in RF communication mode : The block number to access is specified using the block numbers between first and (m-2)th in the block list. The last two block numbers are dummy. The block number of block list should be set in ascending order. The RFID checks that the block number is set in ascending order and if not, it responds with an error.

Note: When specifying multiple blocks, communication mode (RF communication mode) and encrypted communication for all blocks should be configured to the same setting; if not, the RFID responds with an error.

Note: When setting block numbers in ascending order, set to 0x00 following the block number 0xFF (and set to 0x01 following 0x00). Mode setting (bits 2 to 0 of byte D2) for all blocks should be set to the same value.

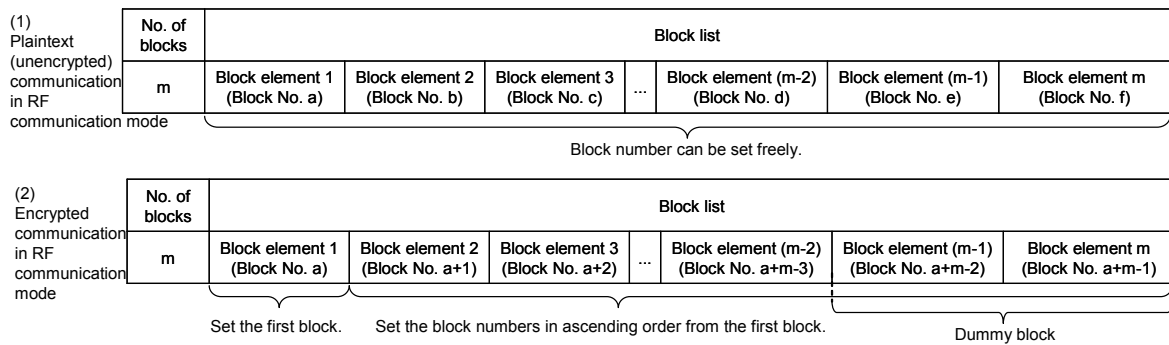

Figure 4-11 Block List Referenced from this RFID

In addition, for encrypted communication, the structure of data is also slightly different from the JISX6319-4 specification. Figure 4-12 shows the block data structure.

(1) Plaintext (unencrypted) communication treats all block data as actual data.

(2) In encrypted communication, of the number of blocks m, the first block data is IV (Initial Vector) to be used for encryption, data from second to (m-1)th blocks are actual data, and the last block data is MAC value for Message Authentication Code (MAC).

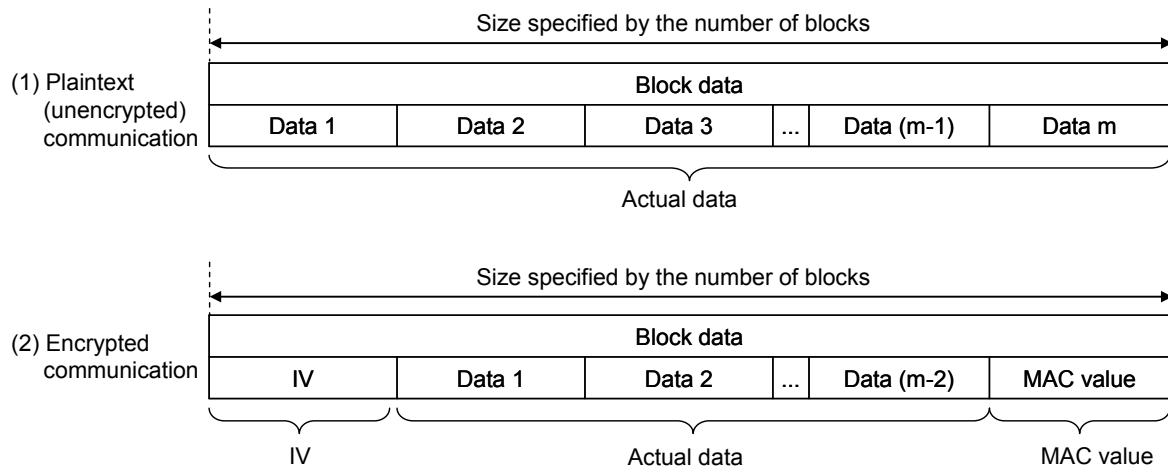

Figure 4-12 Block Data Structure

4.2.5.8 Status Flag

Table 4-8 lists the meanings of status flags.

Table 4-8 Status Flag

| Status flag 1 | Status flag 2 | Meaning | Description |
|---------------|---------------|-------------------------------------|--|
| 0x00 | 0x00 | Normal end | Terminated normally. |
| 0xFF | 0x50 | unmounted mode | mode is un-mounting. |
| 0xFF | 0x51 | unmounted mode | mode is un-mounting. |
| 0xFF | 0xA1 | Service count specification error | The number of service files was out of the specification. |
| 0xFF | 0xA2 | Block count specification error (*) | The number of blocks was out of the specification. |
| 0xFF | 0xA3 | Service count specification error | Some settings for multiple service were different from the specification. |
| 0xFF | 0xA5 | Block specification error | <ul style="list-style-type: none"> • Illegal access mode setting (except All-0) • Illegal mode setting (RFU setting) • Block number was specified outside non-volatile memory. • Ascending order was not used to specify block numbers in encrypted communication. |
| 0xFF | 0x60 | Self-diagnosis error (*) | <ul style="list-style-type: none"> • Write access to non-volatile memory-Read-Only area • Plaintext (unencrypted) command access to Encrypted-communication-enable-only area |

(*) For more information about these errors, see the Administrator's Manual.

4.2.6 Command

Table 4-9 lists the JISX6319-4 commands supported by this RFID.

Subsequent sections describe each command in detail.

Table 4-9 JISX6319-4 Command List

| Name | Code | Description |
|-------|------|--|
| REQ | 0x00 | Reader/writer identifies RFID with this command. |
| READ | 0x06 | Reads data of RFID from reader/writer |
| WRITE | 0x08 | Writes data to RFID from reader/writer |

4.2.6.1 REQ

■ Purpose

Reader/writer identifies RFID with this command.

■ Command message

● Format

| Command code | System code | Request code | Timeslot |
|--------------|-------------|--------------|----------|
| 1 byte | 2 bytes | 1 byte | 1 byte |

● Data field

| Field | Setting | Remarks |
|--------------|--|---|
| Command code | 0x00 | |
| System code | <ul style="list-style-type: none"> 0xFFFF: Identifies all RFIDs. 0xA AFF: Identifies RFID compliant with JIXS6319-4, regardless of category. Other: The RFID corresponding to the specified system code responds. | |
| Request code | <ul style="list-style-type: none"> 0x00: No request 0x01: Additional system code request 0x02: Additional transmission protocol capability request | When values other than the values on the left column are set, the RFID treats this field as 0x00 (no request) |
| Timeslot | 0x00: One slot | This RFID always treats this field as 0x00. |

■ Response message

● Format

| Response code | PICC identifier | Response time descriptor | Request data |
|---------------|-----------------|--------------------------|--------------|
| 1 byte | 8 bytes | 8 bytes | 0 or 2 bytes |

● Data field

| Field | Output value | Remarks |
|--------------------------|---|---------|
| Response code | 0x01 | |
| PICC identifier | See 4.2.5.2 PICC (Proximity IC Card) Identifier. | |
| Response time descriptor | See 4.2.5.3 Response Time Descriptor | |
| Request data | <ul style="list-style-type: none"> Request code 0x00: Request data 0 bytes (No additional data) Request code 0x01: Adds system code. Request code 0x02: 0x0083 (212 kbps, 424 kbps, automatic data rate detection supported) | |

4.2.6.2 READ

■ Purpose

Reads data of RFID from reader/writer.

■ Command message

● Format

| Command code | PICC identifier | No. of service file identifiers (k) | List of service file identifiers | No. of blocks (m) | Block list |
|--------------|-----------------|-------------------------------------|----------------------------------|-------------------|------------------|
| 1 byte | 8 bytes | 1 byte | 2×k bytes | 1 byte | 2×m or 3×m bytes |

● Data field

| Field | Setting | Remarks |
|-------------------------------------|---|--|
| Command code | 0x06 | |
| PICC identifier | PICC identifier acquired by REQ command described in Section 4.2.6.1 REQ. | |
| No. of service file identifiers (k) | Number of service files Setting range: 0x01(1) to 0x0F(15) | When the range other than the range on the left column is set, the RFID responds with an error. |
| List of service file identifiers | Don't care (Setting example: 0x0900) | When specifying multiple services, the RFID responds with an error if all service files are not set to the same value. |
| No. of blocks (m) | Number of blocks specified in block list Setting range: <ul style="list-style-type: none"> • Plaintext (unencrypted) communication in RF communication mode: 0x01(1) to 0x0F(15) • Other: 0x01(1) to 0x0F(15) | When the range other than the range on the left column is set, the RFID responds with an error. |
| Block list | Block list of data to be read For information about how to set, see the following: <ul style="list-style-type: none"> • 4.2.5.6 Block • 4.2.5.7 Block Kist | |

■ Response message

● Format

| Response code | PICC identifier | Status flag 1 | Status flag 2 | No. of blocks (m) | Block data |
|---------------|-----------------|---------------|---------------|-------------------|------------|
| 1 byte | 8 bytes | 1 byte | 1 byte | 1 byte | 16×m byte |

● Data field

| Field | Output value | Remarks |
|-------------------|--|---|
| Response code | 0x07 | |
| PICC identifier | See 4.2.5.2 PICC (Proximity IC Card) Identifier. | |
| Status flag 1 | See 4.2.5.8 Status Flag | |
| Status flag 2 | See 4.2.5.8 Status Flag. | |
| No. of blocks (m) | Number of blocks specified by the command | Omitted when the status is not "Normal end" |
| Block data | See 4.2.5.7 Block List. | Omitted when the status is not "Normal end" |

4.2.6.3 WRITE

■ Purpose

Writes data to RFID from reader/writer.

■ Command message

● Format

| command code | PICC identifier | No. of service file identifiers (k) | List of service file identifiers | No. of blocks (m) | Block list | Block data |
|--------------|-----------------|-------------------------------------|----------------------------------|-------------------|------------------|------------|
| 1 byte | 8 bytes | 1 byte | 2×k bytes | 1 byte | 2×m or 3×m bytes | 16×m bytes |

● Data field

| Field | Setting | Remarks |
|-------------------------------------|---|--|
| Command code | 0x08 | |
| PICC identifier | PICC identifier acquired by REQ command described in Section 4.2.6.1 | |
| No. of service file identifiers (k) | Number of service files Setting range: 0x01(1) to 0x0B(11) | When the range other than the range on the left column is set, the RFID responds with an error. |
| List of service file identifiers | Don't care (Setting example: 0x0900) | When specifying multiple services, the RFID responds with an error if all service files are not set to the same value. |
| No. of blocks (m) | Number of blocks specified in block list Setting range: · No. of service files is 1 to 8: 0x01(1) to 0x0C(12) · No. of service files is 9 to 11: 0x01(1) to 0x0B(11) | When the range other than the range on the left column is set, the RFID responds with an error. |
| Block list | Block list of data to be written For information about how to set, see the following: · 4.2.5.6 Block · 4.2.5.7 Block list | |
| Block data | See 4.2.5.7 Block list | |

■ Response message

● Format

| Response code | PICC identifier | Status flag 1 | Status flag 2 |
|---------------|-----------------|---------------|---------------|
| 1 byte | 8 bytes | 1 byte | 1 byte |

● Data field

| Field | Output value | Remarks |
|-----------------|--|---------|
| Response code | 0x09 | |
| PICC identifier | See 4.2.5.2 PICC (Proximity IC Card) Identifier. | |
| Status flag 1 | See 4.2.5.8 Status Flag. | |
| Status flag 2 | See 4.2.5.8 Status Flag. | |

4.2.7 NDEF

This RFID is based on Type3 Tag and Type4B Tag of NFC Forum and supports data exchange of a NDEF format.

This section explains Type3 Tag.

In addition, 4.3.10 NDEF explains Type4B Tag of NFC Forum.

Data exchange of NDEF can be performed by performing a predetermined setup to the user area of non-volatile memory.

Please refer to the applicable written standards of NFC Forum for the details of NDEF.

4.2.7.1 MEMORY MAP

The memory map at the time of NDEF use is shown in Fig. 4-13

Attribute Information Block is arranged to Block0.

NDEF file is arranged from Block1 to Block23.

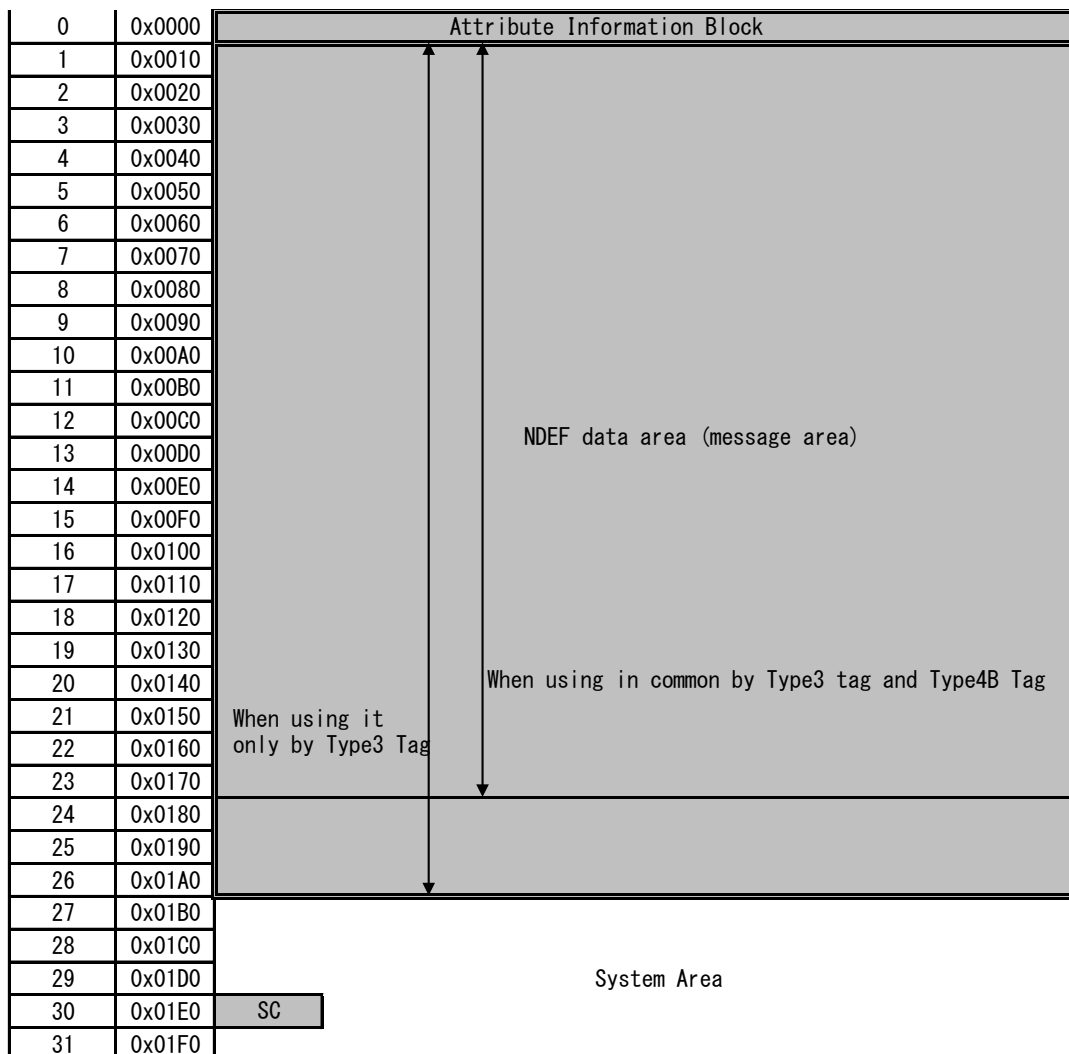

Fig 4-13 The memory map at the time of NDEF use. (NFC Forum Type3 Tag)

4.2.7.2 Setup of System Code (SC)

In order to use NDEF of Type3 Tag, It is necessary to set value "0x12FC." on a system code(SC)

4.2.7.3 Setup of Attribute Information Block

Attribute Information Block(AIB) is arranged to Block0.

Explanation and the example of a setting of Attribute Information Block (AIB) are shown in Table 4-10.

Table 4-10 The example of a setting of Attribute Information Block (AIB)

| Physical address | Size | Value | Contents | Supplement |
|-------------------|-------|------------|--|--|
| 0x0000 | 1Byte | 0x10 | Mapping Version | Please set up according to the NDEF standard version to apply. |
| 0x0001 | 1Byte | 0x0F | Nbr (The number of the maximum block of one read command) | Please set up 0x0F in this RFID. |
| 0x0002 | 1Byte | 0x0B | Nbw (The number of the maximum block of one write command) | Please set up 0x0B in this RFID. |
| 0x0003 ~0x0004 | 2Byte | 0x0017 | Nmaxb (The number of maximum block of NDEF data which can handle this RFID) | (Note:) |
| 0x0005 ~0x0008 | 4Byte | 0x00000000 | Intact area | Please set 4 bytes of 0x00 to all. |
| 0x0009 | 1Byte | 0x00 | WriteF 0x00 : Write-in completion 0x0F : Under a write-in advance | Please set "0x0F" before the writing of a NDEF message, and Please set "0x00" after all the writing of a NDEF message completed, |
| 0x000A | 1Byte | 0x01 | RW-Flag 0x00 : AIB is read-only. 0x01 : Read and write are possible for AIB. | |
| 0x000B ~0x000D | 3Byte | 0x000003 | Ln (NDEF message length) | 0x000003 = 3Byte (The value to a setting example of a setting of Table 4-11) |
| 0x000E ~0x000F | 2Byte | 0x0046 | CheckSum | The sum of data level to address 0x0000 - 0x000D |

Note: When sharing a NDEF message by Type3 Tag and Type4B Tag, the maximum of Nmaxb is 0x0017.

When using it only by Type3 Tag, the maximum of Nmaxb is 0x001A.

However, the maximum of Nmaxb may be set to 0x0018 depending on the directions for encryption communication. Refer to the administrator manual for the details of encryption communication.

4.2.7.4 NDEF FILE

An empty NDEF file is shown in Table 4-11 as an example of a setting of a NDEF file.

Table 4-11 The example of a setting of a NDEF file (An empty NDEF file)

| Physical address | Size | Value | Contents | Supplement |
|-------------------|-------|----------|--------------|--|
| 0x0010 ~0x0012 | 3Byte | 0xD00000 | NDEF Message | A mentioned value is a value which shows an empty message. |

4.3 ISO/IEC14443 TypeB Specification

This section describes the ISO/IEC14443 TypeB specification.

4.3.1 Communication Specification

Table 4-12 provides the communication specifications of this RFID based on ISO/IEC14443 TypeB.

Table 4-12 ISO/IEC14443 TypeB Communication Specification

| | | |
|--------------------------------|----------|---|
| Carrier frequency | | 13.56 MHz |
| Modulation mode, Bit coding | R/W→RFID | ASK10%, NRZ coding |
| | RFID→R/W | Load modulation, BPSK coding (848 kHz subcarrier) |
| Data rate | | 106 kbps / 212 kbps |
| Character transmission | | <ul style="list-style-type: none"> • LSB-first • Data (8 bits) • Start bit (1 bit) • Stop bit (1 bit) |

4.3.2 Frame Format

Figure 4-14 illustrates the ISO/IEC14443 TypeB frame format. SOF(Start Of Frame) and EOF(End Of Frame) are added to a data field. The maximum size of data field is 256 bytes in this RFID.

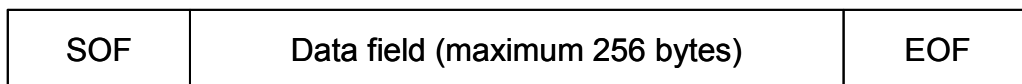

Figure 4-14 ISO/IEC14443 TypeB Frame Format

Additionally, the ISO/IEC14443-4 block format shown in Figure 4-15 is applied to the data field shown in Figure 4-14. This RFID does not support CID and NAD of the first field, so adding them is prohibited.

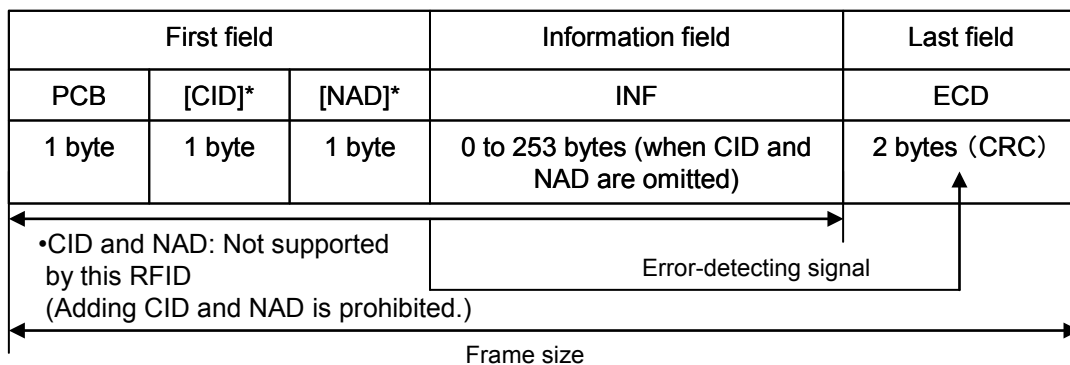

Figure 4-15 ISO/IEC14443-4 Block Format

Table 4-13 ISO/IEC14443-4 Field Definition

| Field name | Byte length | Definition |
|------------|-------------|--|
| PCB | 1 | Protocol Control Byte. See 4.3.3 Protocol Control |
| CID | 1 | Card Identifier (optional) Used to identify RFID. (Not supported by this RFID; not added.) |
| NAD | 1 | Node Address (optional). Used to establish a logical channel. (Not supported by this RFID; not added.) |
| INF | n | Command message or response message |
| ECD | 2 | See CRC_B ISO/IEC14443-3. |

4.3.3 Protocol Control

PCB (Protocol Control Byte) shown in Figure 4-15 and Table 4-13 is provided for ISO/IEC14443-4 protocol control, and used to send information necessary for data transmission control. This protocol has 3 block types. Table 4-14 lists the definition of block type. This RFID's protocol control specification is given in Table 4-15.

Figure 4-16, Figure 4-17, and Figure 4-18 illustrate I-block, R-block, and S-block codings, respectively.

Table 4-14 Block Type

| Block name | Definition |
|------------|---|
| I-block | Used to send the information of application layer. |
| R-block | Used to send ACK (Acknowledge) or NAK (NegativeAcknowledge). R-block does not include INF field. An R-block corresponding to the last reception block will be sent. |
| S-block | Used to send a control information. The following 2 types are provided: 1. Wait time extension request (WTX) 2. DESELECT command |

Table 4-15 Protocol Control Specification

| Item | Description | By this RFID |
|-----------------------|--|--|
| CID (Card Identifier) | First field parameter of ISO/IEC14443-4 frame (optional). Used to identify RFID. | Not supported |
| NAD (Node Address) | First field parameter of ISO/IEC14443-4 frame (optional). Used to establish a logical channel. | Not supported |
| Chaining | Used to transmit/receive divided data | Supported (however, the size of divisible frame size is 64 bytes or more.) |
| ACK/NCK response | Used to send ACK (Acknowledge) or NAK (NegativeAcknowledge). | Supported |
| WTX | Used to extend the wait time for response from RFID | Not supported |
| DESELECT command | Used to deselect the RFID. | Supported |

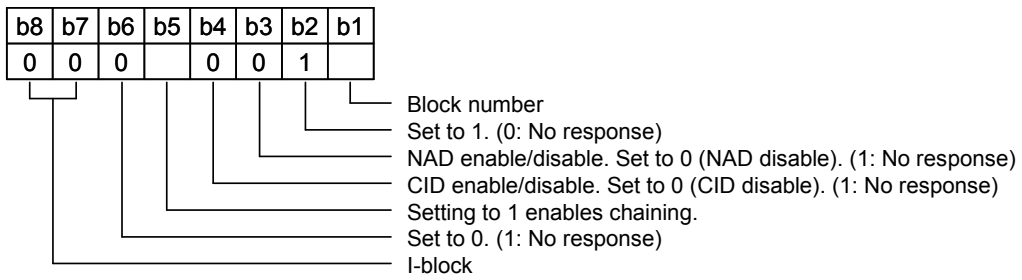

Figure 4-16 I-block Coding

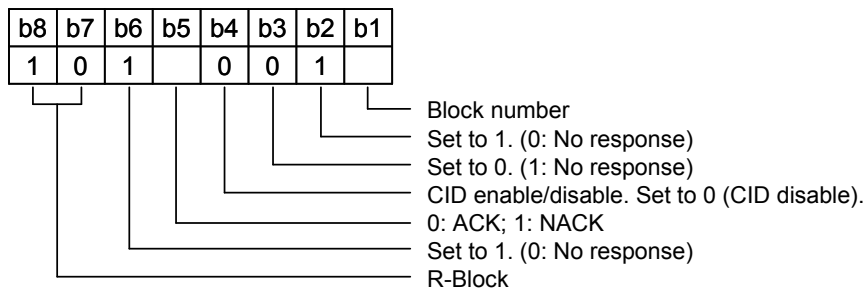

Figure 4-17 R-block Coding

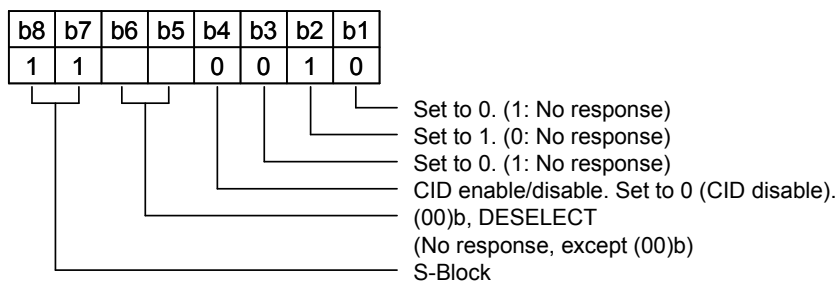

Figure 4-18 S-block Coding

4.3.4 Block Control

The block number rule for ISO/IEC14443-4 I-block is given in Table 4-16. The block control rule and whether to be supported by this RFID are shown in Table 4-17.

Table 4-16 Block Number Rule

| Applied to | No. | Rule |
|-------------------|-------|--|
| Reader/ Writer | RuleA | Set the initial value of reader/writer block number to 0 whenever activating RFID. |
| | RuleB | When I-block or R(ACK) block whose block number is equal to the current one is received, toggle the current block number before sending the block number to RFID. |
| RFID | RuleC | Set the initial value of RFID block number to 1 whenever activating RFID. |
| | RuleD | When I-block is received, toggle the current block number before sending the block. |
| | RuleE | When R(ACK) block whose block number is not equal to the current one is received, RFID toggles the current block number before sending the block. When R(NAK) is received, do not toggle the block number. |

Table 4-17 Block Control Rule

| Applied to | No. | Rule | By this RFID |
|-------------------------------|--------|--|-------------------------|
| Reader/ Writer and RFID | Rule1 | Send the first block from reader/writer. | Supported |
| | Rule2 | When I-block indicating chaining is received, send an affirmative response to the block, with R(ACK) block. | Supported |
| | Rule3 | S-block is used only for pair. Send a response to S(...)block whenever S(...)block is requested. | Only DESELECT supported |
| Reader/ Writer | Rule4 | When an illegal block is received or FWT timeout occurs, send R(NAK) block (except while RFID is in chaining or when S(DESELECT) is executed). | - |
| | Rule5 | When an illegal block is received or FWT timeout occurs while RFID is in chaining, send R(ACK) block. | - |
| | Rule6 | When R(ACK) block is received and its block number is not equal to the block number of reader/writer, re-send the last I-block. | - |
| | Rule7 | When R(ACK) block is received and its block number is equal to the block number of reader/writer, continue chaining. | - |
| | Rule8 | When a response to S(DESELECT) is not sent with no error, re-send S(DESELECT) or ignore the RFID. | - |
| RFID | Rule9 | RFID can send S(WTX) block, instead of I-block or R(ACK) block. | Not supported |
| | Rule10 | When I-block not indicating chaining is not received, send an affirmative response. | Supported |
| | Rule11 | When R(ACK) or R(NAK) block is received and its block number is equal to the block number of RFID, re-send the last I-block. | Supported |
| | Rule12 | When R(NAK) block is received and its block number is not equal to the block number of RFID, send R(ACK). | Supported |
| | Rule13 | When R(ACK) block is received and its block number is not equal to the block number of RFID and RFID is in chaining, continue chaining. | Supported |

4.3.5 Upper Command Format

The upper commands (SELECT, READ, WRITE) are compliant with the APDU (Application Protocol Data Unit) format of ISO/IEC7816-4.

Figure 4-19 shows the command APDU format. Table 4-18 shows the command APDU field definition. Figure 4-20 gives the response APDU format. Table 4-19 gives the response APDU field definition.

The command APDU format shown in Figure 4-19 and the response APDU format shown in Figure 4-20 are configured in the information field INF of the ISO/IEC14443-4 block format shown in Figure 4-15.

| CLA | INS | P1 | P2 | Lc | Data | Le |
|------------|------------------|------------|------------|----------|----------------------|----------|
| Class byte | Instruction byte | Param byte | Param byte | Lc field | Data byte (Lc bytes) | Le field |

Figure 4-19 Command APDU Format

Table 4-18 Command APDU Field Definition

| Field name | Byte length | Definition |
|------------------|-------------|--|
| Class byte | 1 | Fixed to 0x00 |
| Instruction byte | 1 | Instruction code |
| Param byte 1 | 1 | Command parameter |
| Param byte 2 | 1 | Command parameter |
| Lc field | 1 | If a data byte exists in the command APDU, set the byte length of n; if not, omit the data byte. |
| Data byte | n | Data block (can be omitted) |
| Le field | 1 | If a data byte exists in the response APDU, set the byte length; if not, omit the data byte. |

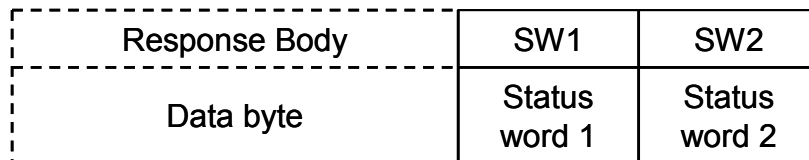

Figure 4-20 Response APDU Format

Table 4-19 Response APDU Field Definition

| Field name | Byte length | Definition |
|---------------|-------------|-----------------------------|
| Data byte | n | Data block (can be omitted) |
| Status word 1 | 1 | Status information |
| Status word 2 | 1 | Status information |

4.3.6 State Transition Diagram

Figure 4-21 provides the state transition diagram for this RFID's operation based on ISO/IEC14443 TypeB.

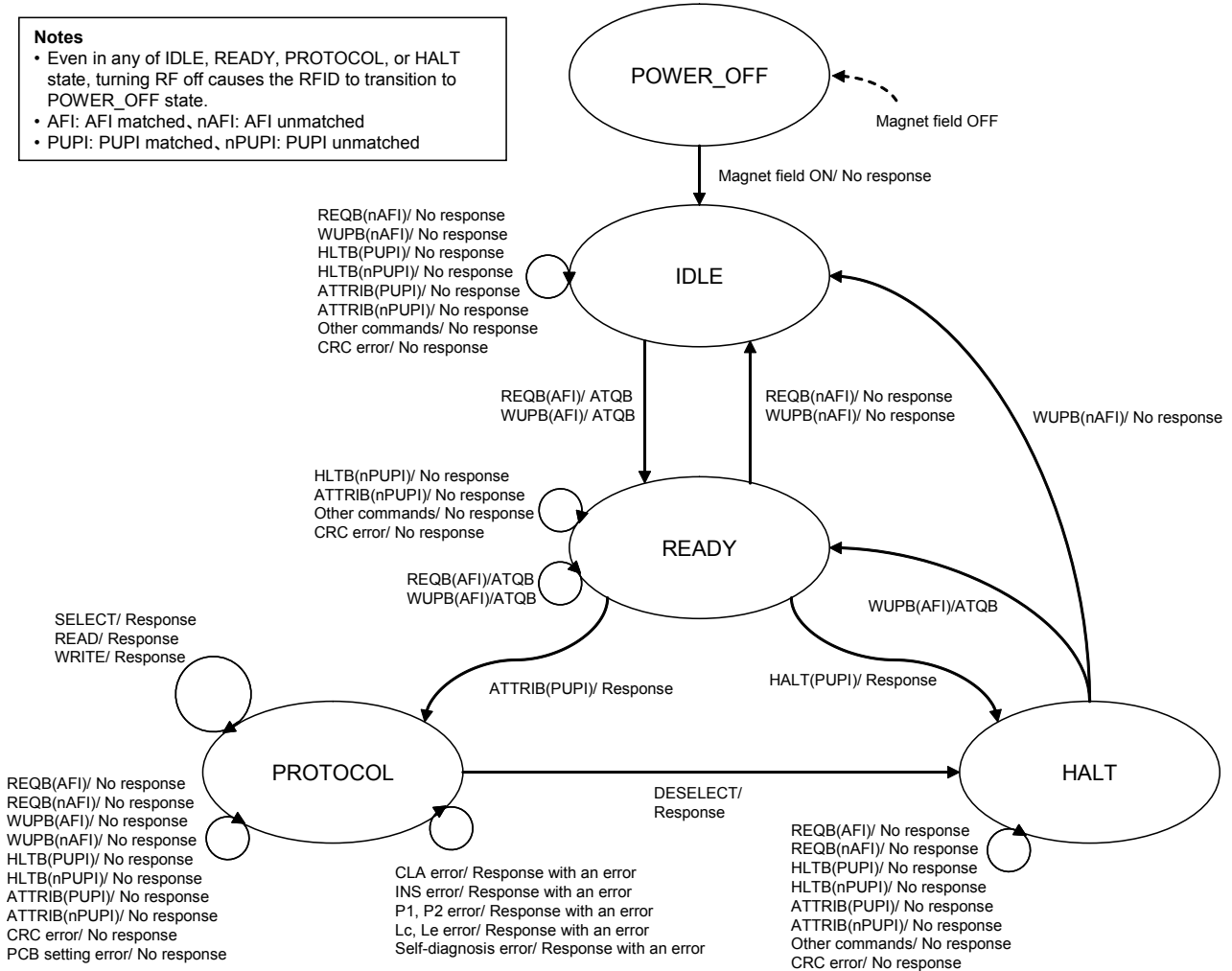

Figure 4-21 State Transition Diagram for Operation Based on ISO/IEC14443 TypeB

4.3.7 Flow Chart

Figure 4-22 illustrates the flow chart for this RFID's command processing based on ISO/IEC14443 TypeB.

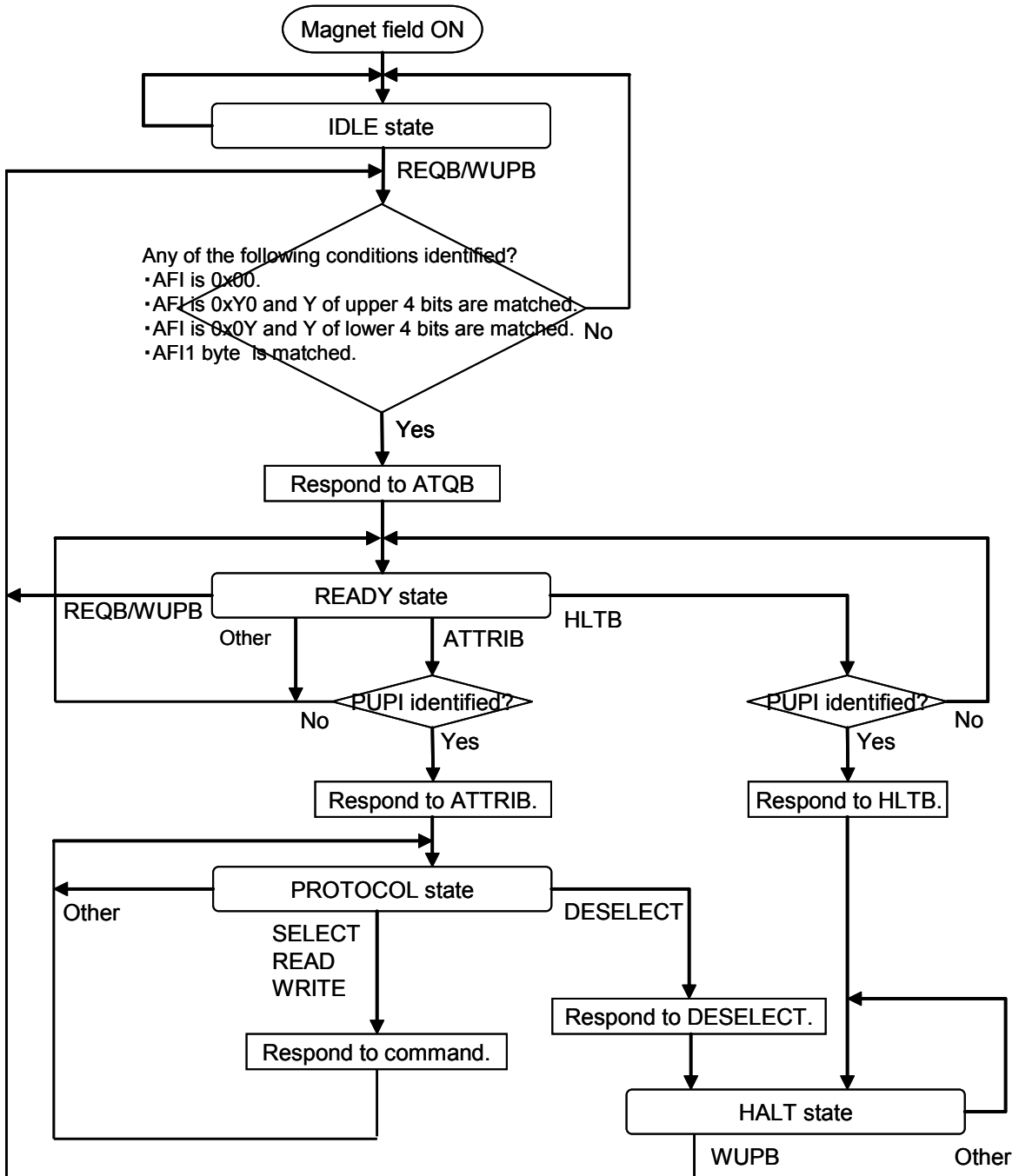

Figure 4-22 Flow Chart of Command Processing Based on ISO/IEC14443 TypeB

4.3.8 Various Settings

This section describes the parameter settings and operation specifications based on ISO/IEC14443 TypeB for this RFID.

4.3.8.1 AFI (Application Family Identifier)

Figure 4-23 shows the format of AFI (Application Family Identifier). The value of AFI is set in the system area AFI.

AFI is a parameter specified by the REQB command. The response operation to REQB command in this RFID is shown in Table 4-20. For information about the setting values for AFI, see ISO/IEC14443-3.



Figure 4-23 AFI Format

Table 4-20 REQB Command Response Operation

| REQB command AFI setting value | RFID's response to REQB command |
|-----------------------------------|--|
| 0x00 | Responds regardless of the system area AFI setting. |
| 0xY0 | Responds when the value Y of the upper 4 bits of the REQB command's AFI is matched. |
| 0x0Y | Responds when the value Y of the lower 4 bits of the REQB command's AFI is matched. |
| Other | Responds only when the setting value of the REQB command's AFI matches the value specified in the system area AFI. |

4.3.8.2 PUPI (Pseudo-Unique PICC Identifier)

Figure 4-24 shows the format of PUPI (Pseudo-Unique PICC Identifier). PUPI is an identifier of PICC (Proximity IC Card). The value of PUPI is set in the lower 4 bytes of the system area IDM.

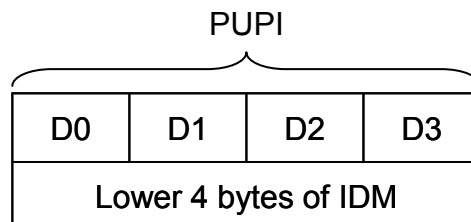

Figure 4-24 PUPI Format

4.3.8.3 FWI (Frame Waiting Time Integer)

Figure 4-25 shows the format of FWI (Frame Waiting time Integer). FWI is used to specify the maximum wait time until the PICC sends a response after receiving a command.

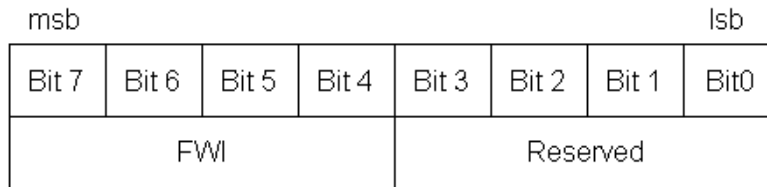

Figure 4-25 FWI Format

The maximum wait time is calculated by the following formula:

$$\text{Maximum wait time} = T \times 2^{\text{FWI}}$$

$$T: 256 \times 16 / f_c \text{ (} f_c = 13.56 \text{ MHz, approx. } 0.302 \text{ ms)}$$

$$\text{FWI: } 0 \text{ to } 14 \text{ (integer)}$$

The maximum wait time ranges from approximately 0.302 ms (min.; FWI = 0) to approximately 4.949 s (max; FWI = 14).

4.3.8.4 File System

This RFID is compliant with the command specification of ISO/IEC7816-4 standards, but does not implement the file system functionality of the standards. However, in order to ensure the compatibility with communication to reader/writer, the SELECT command to select files is set to "Normal response" when specifying the given parameters. For information about how to set the parameters of the SELECT command, see 4.3.9.4 SELECT.

4.3.8.5 Address

In ISO/IEC14443 TypeB (command is compliant with ISO/IEC7816-4), the addresses of READ and WRITE commands are specified by bytes P1 and P2 of the command APDU. (See Section 4.3.5 Upper Command Format)

Figure 4-26 shows the address specification format. Set bit 7 of byte P1 to 0; setting to 1 causes an error.

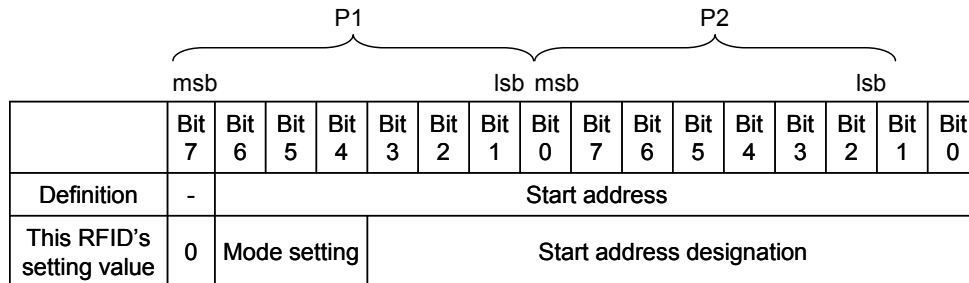

Figure 4-26 Address Specification

This RFID uses address to specify encrypted communication. Table 4-21 shows mode settings including encrypted communication with bits 6 to 4 of byte P1.

Table 4-21 Mode Settings

| Byte P1 | | | Meaning | |
|---------|-------|-------|--|---------------------------------------|
| Bit 6 | Bit 5 | Bit 4 | Communication mode | Encrypted communication |
| - | - | - | RF communication mode | Plaintext (unencrypted) communication |
| 0 | 0 | 0 | | Encrypted communication (private key) |
| 0 | 1 | 0 | | Encrypted communication (family key) |
| 0 | 1 | 1 | Reserved (Setting this field causes an error.) | |
| 0 | 0 | 1 | | |
| 1 | 0 | 0 | | |
| 1 | 1 | 0 | | |
| 1 | 1 | 1 | Reserved (Setting this field causes an error.) | |
| 1 | 0 | 1 | | |

In addition, Table 4-22 shows the setting unit for address by communication mode.

Table 4-22 Setting Unit for Address

| Communication mode | Setting unit for address (n: integer) |
|-------------------------|---------------------------------------|
| Plaintext (unencrypted) | 1×n bytes |
| Encrypted | 16×n bytes |

Note: Setting the address to a value other than 16 × n bytes in encrypted communication causes the RFID to respond with an error.

4.3.8.6 Data

For encrypted communication, the structure of data block for READ and WRITE commands is slightly different from the ISO/IEC7816-4 command specification. Figure 4-27 shows the data block structure.

(1) Plaintext (unencrypted) communication treats all block data as actual data.

(2) In encrypted communication, the first 16 bytes of data is IV (Initial Vector) used for encryption, following $16 \times n$ bytes of data is actual data, and the last 16 bytes is MAC value for Message Authentication Code (MAC).

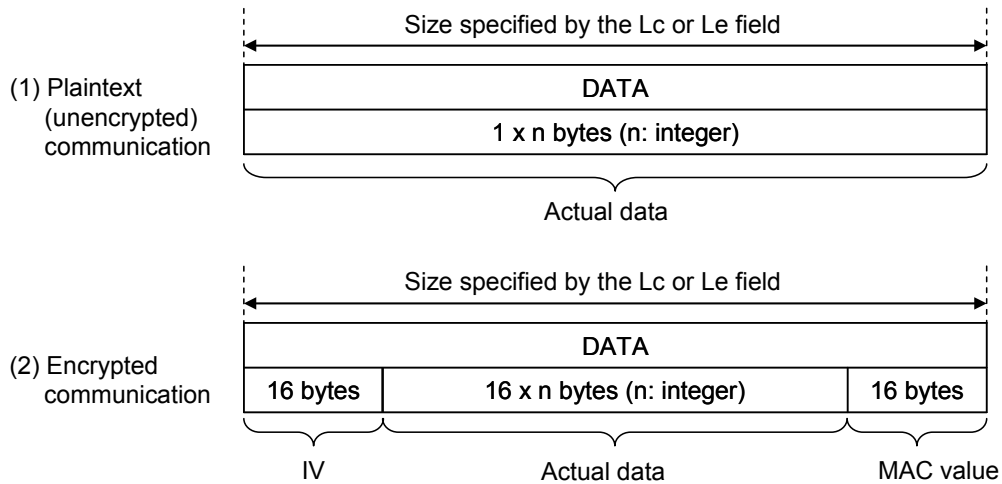

Figure 4-27 Data Block Structure

Note: Setting the data length to a value other than $16 \times n$ bytes in encrypted communication causes the RFID to respond with an error.

4.3.8.7 Status Word

Table 4-23 lists the meaning of statuses.

Table 4-23 Status Word

| SW1 | SW2 | Meaning | Description |
|------|------|--------------------------------|--|
| 0x90 | 0x00 | Normal end | Terminated normally. |
| 0x50 | 0x00 | unmounted mode | mode is un-mounting. |
| 0x51 | 0x00 | unmounted mode | mode is un-mounting. |
| 0x67 | 0x00 | Lc/Le specification error (*1) | <ul style="list-style-type: none"> • Lc and Le were out of the specification. • In encrypted communication, Lc and Le were not 16×n bytes. |
| 0x6A | 0x86 | P1-P2 specification error | <ul style="list-style-type: none"> • Bit 7 of P1 was not 0. (*2) • Illegal mode setting (RFU setting) • Specified outside non-volatile memory. • In encrypted communication, the address was not specified in 16×n byte units. |
| 0x6D | 0x00 | INS specification error | Illegal INS setting (Specified an unimplemented command) |
| 0x6E | 0x00 | CLA specification error | Illegal CLA setting (except 0x00) |
| 0x6F | 0x00 | Self-diagnosis error (*1) | <ul style="list-style-type: none"> • Write access to non-volatile memory-Read-Only area • Plaintext (unencrypted) command access to Encrypted-communication-enable-only area |

(*1) For more information about these errors, see the Administrator's Manual.

(*2) In the case of SELECT command, it may become "Lc, Le error 0x6700" depending on the combination of values of P1,P2.

4.3.9 Command

The commands based on ISO/IEC14443 TypeB supported by this RFID fall into two types:

Commands defined in ISO/IEC14443-3, and APDU commands defined in ISO/IEC7816-4 to be sent in the ISO/IEC14443-4 format.

These commands are shown in Table 4-24 and Table 4-25.

For information about the command format, see Section 4.3.2 Frame Format and Section 4.3.5 Upper Command Format.

Additionally, protocol control such as chaining, ACK/NAK response (R-Block), and DESELECT (S-Block) are also supported. For its detail, see Section 4.3.3 Protocol Control.

Subsequent sections describe each command in detail.

Table 4-24 ISO/IEC14443-3 TypeB Command List

| Name | Code | Description |
|-----------|------|--|
| REQB/WUPB | 0x05 | Identifies the RFID. Used by reader/writer. |
| ATTRIB | 0x1D | Exchanges protocol signal information between reader/writer and RFID, and causes the RFID to transition to the state in which command processing is enabled. |
| HLTB | 0x50 | Transitions the RFID to a HALT state. Used by reader/writer. |

Table 4-25 APDU Command List

| Name | INS | Description |
|--------|------|--|
| SELECT | 0xA4 | Selects the file. (No processing is performed in this RFID.) |
| READ | 0xB0 | Reads the data of RFID from reader/writer. |
| WRITE | 0xD6 | Writes a data to RFID from reader/writer. |

4.3.9.1 REQB/WUPB

■ Purpose

Identifies the RFID. Used by reader/writer

- REQB is used when the RFID is in IDLE state.
- WUPB is used when the RFID is in HALT state. (It can be also used in IDLE state.)

■ Command message

● Format

| Command code | AFI | PARAM | CRC_B |
|--------------|--------|--------|---------|
| 1 byte | 1 byte | 1 byte | 2 bytes |

● Data field

| Field | Setting | Remarks |
|--------------|---|---|
| Command code | 0x05 | |
| AFI | 0x00: Identifies all RFIDs. 0xY0: RFID whose upper 4 bits are identified responds. 0x0Y: RFID whose lower 4 bits are identified responds. Other than 0x00: RFID corresponding to the specified system code responds. | See 4.3.8.1 AFI (Application Family Identifier). |
| PARAM | 0x00: REQB 0x08: WUPB | This RFID always operates as follows: · Ignores the setting of bits 7-5. · Recognizes the number N of Slots is 1 (always responds with ATQB) even when bits 2-0 are set to any of the values (including PFU). |
| | Bits 7-5 RFU (Set to 000b.) | |
| | Bit 4 0: Extension ATQB not supported 1: Extension ATQB supported | |
| | Bit 3 0: REQB 1: WUPB | |
| | Bits 2-0 000b: Slot count N = 1 001b: Slot count N = 2 010b: Slot count N = 4 011b: Slot count N = 8 100b: Slot count N = 16 101b: RFU 110b: RFU | |
| CRC_B | See CRC_B ISO/IEC14443-3. | |

■ Response message

● Format

| | | | | |
|---------------|---------|------------------|---------------|---------|
| Response code | PUPI | Application data | Protocol info | CRC_B |
| 1 byte | 4 bytes | 4 bytes | 3 bytes | 2 bytes |

● Data field

| Field | Output value | Remarks | |
|------------------|--|--|---|
| response code | 0x50 (ATQB) | | |
| PUPI | See 4.2.5.2 PICC (Proximity IC Card) Identifier. | | |
| Application Data | 0x00000000 | Reserved (treated as proprietary data.) | |
| Protocol Info | 1st byte: 0x91 | For more information about parameters, see ISO/IEC14443-3. | |
| | Bits 7-0 | | Data rate setting: 0x91 <ul style="list-style-type: none"> • R/W→RFID: 106K, 212K bps • RFID→R/W: 106K, 212K bps • R/W→RFID, RFID→R/W (same data rate) |
| | 2nd byte: 0x81 | | |
| | Bits 7-4 | | Maximum frame size of RFID 1000b: 256 bytes |
| | Bits 3-0 | | Protocol type: 0001b <ul style="list-style-type: none"> • RFID is ISO/IEC14443-4 compliant • Minimum reader/writer command wait time (TR2) after RFID responds: 10etu + 32/fs (fs = 848 kHz) |
| | 3rd byte: 0xX0 (X is a value of FWI.) | | |
| | Bits 7-4 | | FWI (Frame Waiting time Integer) See 4.3.8.3 FWI (Frame Waiting Time Integer). |
| | Bits 3-2 | | ADC (Application Data Coding) 00b: Proprietary Application Data |
| Bits 1-0 | FO (Frame Option) 00b: NAD, CID not supported | | |
| CRC_B | See CRC_B ISO/IEC14443-3. | | |

4.3.9.2 ATTRIB

■ Purpose

Exchanges protocol signal information between reader/writer and RFID, and causes the RFID to transition to the state in which command processing is enabled.

■ Command message

● Format

| Command code | Identifier | Param1 | Param2 | Param3 | Param4 | CRC_B |
|--------------|------------|--------|--------|--------|--------|---------|
| 1 byte | 4 bytes | 1 byte | 1 byte | 1 byte | 1 byte | 2 bytes |

● Data field

| Field | Setting | | Remarks |
|--------------|--|---|--|
| Command code | 0x1D | | |
| Identifier | Sets PUPI for ATQB response. | | |
| Param1 | 0x00 | | This RFID operates with: • bits 1-0 ignored • bits 7-6 set to 00b (when these bits are set to 11b) • bits 5-4 set to 00b (when these bits are set to 11b) This RFID operates with: • Minimum TR0: 64/fs • Minimum TR1: 80/fs • EOF not omitted • SOF not omitted |
| | Bits 7-6 | Minimum value of RFID response time to reader/writer command (TR0): (fs = 848 kHz) 00b: 64/fs (106 Kbps), 64/fs (212 Kbps) 01b: 48/fs (106 Kbps), 32/fs (212 Kbps) 10b: 16/fs (106 Kbps), 8/fs (212 Kbps) 11b: RFU | |
| | Bits 5-4 | Minimum value of the time (TR1) until RFID starts data transmission after subcarrier is generated: (fs = 848 kHz) 00b: 80/fs (106 Kbps), 80/fs (212 Kbps) 01b: 64/fs (106 Kbps), 32/fs (212 Kbps) 10b: 16/fs (106 Kbps), 8/fs (212K bps) 11b: RFU | |
| | Bit 3 | 0: Do not omit EOF. 1: Omit EOF. | |
| | Bit 2 | 0: Do not omit SOF. 1: Omit SOF. | |
| | Bits 1-0 | RFU (Set to 00b.) | |
| Param2 | 0xXX (For XX, see the settings below.) | | • If parameters other than those on the left (communication settings or reader/writer frame size which the RFID does not support) are set, the RFID will generate no response. • If the data rate setting differs between RFID→PCD and PCD→RFID, the RFID will generate no response. |
| | Bits 7-6 | RFID→PCD data rate 00b: 106 Kbps 01b: 212 Kbps | |
| | Bits 5-4 | PCD→PICC data rate 00b: 106 Kbps 01b: 212 Kbps | |
| | Bits 3-0 | Maximum receptive frame size of reader/writer 1000b: 256 bytes 0111b: 128 bytes 0110b: 96 bytes 0101b: 64 bytes | |

| | | | |
|--------|---------------------------|---|--|
| Param3 | 0x01 | | If parameters other than those on the left are set, the RFID will generate no response. |
| | Bits 7-4 | RFU (Set to 0000b.) | |
| | Bits 3-0 | Set to the same value as that for the protocol type (4 bits) of the ATQB parameter's second byte. | |
| Param4 | 0x00 | | The RFID operates with: · bits 7-4 ignored · no response generated except when bits 3-0 are set to 0000b |
| | Bits 7-4 | RFU (Set to 0000b.) | |
| | Bits 3-0 | 0000b: RFID does not support CID. | |
| CRC_B | See CRC_B ISO/IEC14443-3. | | |

■ Response message

● Format

| | |
|---------------|---------|
| Response code | CRC_B |
| 1 byte | 2 bytes |

● Data field

| Field | Output value | | Remarks |
|---------------|---------------------------|--|--|
| response code | 1st byte: 0x10 | | For more information about parameters, see ISO/IEC14443-3. |
| | Bits 7-4 | MBLI (Maximum Buffer Length Integer) 0001b: 1x of RFID frame size (256 bytes) | |
| | Bits 3-0 | 0000b: RFID does not support CID. | |
| CRC_B | See CRC_B ISO/IEC14443-3. | | |

4.3.9.3 HLTB

- Purpose

Causes the RFID to transition to a HALT state. Used by reader/writer.

- Command message

- Format

| | | |
|--------------|------------|---------|
| Command code | Identifier | CRC_B |
| 1 byte | 4 bytes | 2 bytes |

- Data field

| Field | Setting | Remarks |
|--------------|--|---------|
| Command code | 0x50 | |
| Identifier | Sets the PUPI of the RFID to be set to a HALT state. | |
| CRC_B | See CRC_B ISO/IEC14443-3. | |

- Response message

- Format

| | |
|---------------|---------|
| Response code | CRC_B |
| 1 byte | 2 bytes |

- Data field

| Field | Output value | Remarks |
|---------------|---------------------------|---------|
| Response code | 0x00 | |
| CRC_B | See CRC_B ISO/IEC14443-3. | |

4.3.9.4 SELECT

■ Purpose

Selects the file.

This RFID conforms to the NDEF Ver. 2.0 of NFC forum Type 4B tag and therefore is capable of performing the following selections: EF file, NDEF application, CC file, or NDEF file.

For operations at CC or NDEF file selections, see Section 4.3.10.3 CC File and Section 4.3.10.4 NDEF File.

■ Command message

● Format

| CLA | INS | P1 | P2 | Lc | Data | Le |
|--------|--------|--------|--------|--------|---------|--------|
| 1 byte | 1 byte | 1 byte | 1 byte | 1 byte | n bytes | 1 byte |

● Data field

| Field | Setting | Remarks |
|-------|--|---|
| CLA | 0x00 | Responds with an error, except 0x00. |
| INS | 0xA4 | |
| P1 | 0x00: Selection by a file identifier 0x02: EF file selection 0x04: Selection by DF name (Selection by an application identifier) | A combination except follows is an error reply P1,P2=0x020C : EF file choice |
| P2 | 0x00: Designate the corresponding file. 0x0C: FCI generates no response. | P1,P2=0x0400 : NDEF tag application choice P1,P2=0x000C : EF file, CC file or NDEF file choice |
| Lc | Sets the byte length of the Data block. · Setting range: NDEF tag application selection (when P1, P2 = x0400): 0x07(7) Other than the above: 0x02(2) | Responds with an error, except the setting range on the left column. |
| Data | NDEF tag application selection (when P1, P2 = x0400): 0xD2760000850101 CC file selection (when P1, P2 = 000C): 0xE103 NDEF file selection (when P1, P2 = 000C): 0x0103 EF file selection (when P1, P2 = 020C): Don't care (This field is set by EF-ID.) | Responds with an error, except the settings on the left column. |
| Le | Sets the byte length of the Data block for response. · Setting range: 0x00 (with field only for NDEF tag application selection) | Responds with an error, except the setting range on the left column. |

- Setting examples

- EF file selection

| CLA | INS | P1 | P2 | Lc | Data |
|------|------|------|------|------|--------|
| 0x00 | 0xA4 | 0x02 | 0x0C | 0x02 | 0XXXXX |

In case of the P1,P2=0x020C setting, any value of Data(EF-ID) is settable.

| CLA | INS | P1 | P2 | Lc | Data |
|------|------|------|------|------|--------|
| 0x00 | 0xA4 | 0x02 | 0x0C | 0x02 | 0XXXXX |

In case of the P1,P2=0x000C setting, please set Data(EF-ID) any place other than 0xE103 and 0x0103.

- NDEF tag application selection

| CLA | INS | P1 | P2 | Lc | Data | Le |
|------|------|------|------|------|------------------|------|
| 0x00 | 0xA4 | 0x04 | 0x00 | 0x07 | 0xD2760000850101 | 0x00 |

In case of the NDEF tag application choice, only the value mentioned above is settable.

- CC file selection

| CLA | INS | P1 | P2 | Lc | Data |
|------|------|------|------|------|--------|
| 0x00 | 0xA4 | 0x00 | 0x0C | 0x02 | 0xE103 |

In case of the CC file application choice, only the value mentioned above is settable.

- NDEF file selection

| CLA | INS | P1 | P2 | Lc | Data |
|------|------|------|------|------|--------|
| 0x00 | 0xA4 | 0x00 | 0x0C | 0x02 | 0x0103 |

In case of the NDEF file application choice, only the value mentioned above is settable.

ID(File ID) of the NDEF file in this RFID is 0x0103 fixation.

- Response message

- Format

| SW1 | SW2 |
|--------|--------|
| 1 byte | 1 byte |

- Data field

| Field | Output value | Remarks |
|-------|--------------------------|---------|
| SW1 | See 4.3.8.7 Status Word. | |
| SW2 | See 4.3.8.7 Status Word. | |

4.3.9.5 READ

■ Purpose

Reads the data of RFID from reader/writer.

■ Command message

● Format

| CLA | INS | P1 | P2 | Le |
|--------|--------|--------|--------|--------|
| 1 byte | 1 byte | 1 byte | 1 byte | 1 byte |

● Data field

| Field | Setting | Remarks |
|-------|---|---|
| CLA | 0x00 | Responds with an error, except 0x00. |
| INS | 0xB0 | |
| P1 | Sets the start address to be read. · See 4.3.8.5 Address. | |
| P2 | Sets the start address to be read. · See 4.3.8.5 Address | |
| Le | Sets the byte length of data to be read. · Setting range: 0x01(1) to 0xFB(251) · Sets to 16×n (n: integer) for encrypted communication. | Maximum value of n is 15 for encrypted communication. |

■ Response message

● Format

| Data | SW1 | SW2 |
|----------------|--------|--------|
| 1 to 251 bytes | 1 byte | 1 byte |

● Data field

| Field | Output value | Remarks |
|-------|--|--|
| Data | Sets the data to be read. · See 4.3.8.6 Data. | Omitted except when status word ends normally. |
| SW1 | See 4.3.8.7 Status Word. | |
| SW2 | See 4.3.8.7 Status Word. | |

4.3.9.6 WRITE

■ Purpose

Writes a data to RFID from reader/writer.

■ Command message

● Format

| CLA | INS | P1 | P2 | Lc | Data |
|--------|--------|--------|--------|--------|----------------|
| 1 byte | 1 byte | 1 byte | 1 byte | 1 byte | 1 to 248 bytes |

● Data field

| Field | Setting | Remarks |
|-------|--|---|
| CLA | 0x00 | Responds with an error, except 0x00. |
| INS | 0xD6 | |
| P1 | Sets the start address of data to be written. · See 4.3.8.5 Address | |
| P2 | Sets the start address of data to be written. · See 4.3.8.5 Address | |
| Lc | Sets the byte length of the Data block. · Setting range: 0x01(1) to 0xF8(248) · Sets to 16×n (n: integer) for encrypted communication. | Maximum value of n is 15 for encrypted communication. |
| Data | Sets the data to be written. · See 4.3.8.6 Data. | |

■ Response message

● Format

| SW1 | SW2 |
|--------|--------|
| 1 byte | 1 byte |

● Data field

| Field | Output value | Remarks |
|-------|--------------------------|---------|
| SW1 | See 4.3.8.7 Status Word. | |
| SW2 | See 4.3.8.7 Status Word. | |

4.3.10 NDEF

This RFID is based on Type3 Tag and Type4B Tag of NFC Forum and supports data exchange of a NDEF format

This section explains Type4B Tag.

In addition, 4.2.7 NDEF explains Type3 Tag of NFC Forum.

Data exchange of NDEF can be performed by performing a predetermined setup to the user area of non-volatile memory. Please refer to the applicable written standards of NFC Forum for the details of NDEF.

4.3.10.1 Memory Map

Fig 4-28 shows the memory map in NDEF format.

CC file is assigned to Block 24. NDEF file is assigned to part of Block 0, and Blocks 1 to 23.

| Block | Address | 0x0 | 0x1 | 0x2 | 0x3 | 0x4 | 0x5 | 0x6 | 0x7 | 0x8 | 0x9 | 0xA | 0xB | 0xC | 0xD | 0xE | 0xF |
|-------|---------|--------------------------|-----|-----|-----|-----|-----|-----|-----|-----|-----|-----|-----|-----|-----|-----|-----|
| 0 | 0x0000 | | | | | | | | | | | | | | | | |
| 1 | 0x0010 | NDEF Data Area (Message) | | | | | | | | | | | | | | | |
| 2 | 0x0020 | | | | | | | | | | | | | | | | |
| 3 | 0x0030 | | | | | | | | | | | | | | | | |
| 4 | 0x0040 | | | | | | | | | | | | | | | | |
| 5 | 0x0050 | | | | | | | | | | | | | | | | |
| 6 | 0x0060 | | | | | | | | | | | | | | | | |
| 7 | 0x0070 | | | | | | | | | | | | | | | | |
| 8 | 0x0080 | | | | | | | | | | | | | | | | |
| 9 | 0x0090 | | | | | | | | | | | | | | | | |
| 10 | 0x00A0 | | | | | | | | | | | | | | | | |
| 11 | 0x00B0 | | | | | | | | | | | | | | | | |
| 12 | 0x00C0 | | | | | | | | | | | | | | | | |
| 13 | 0x00D0 | | | | | | | | | | | | | | | | |
| 14 | 0x00E0 | | | | | | | | | | | | | | | | |
| 15 | 0x00F0 | | | | | | | | | | | | | | | | |
| 16 | 0x0100 | | | | | | | | | | | | | | | | |
| 17 | 0x0110 | | | | | | | | | | | | | | | | |
| 18 | 0x0120 | | | | | | | | | | | | | | | | |
| 19 | 0x0130 | | | | | | | | | | | | | | | | |
| 20 | 0x0140 | | | | | | | | | | | | | | | | |
| 21 | 0x0150 | | | | | | | | | | | | | | | | |
| 22 | 0x0160 | | | | | | | | | | | | | | | | |
| 23 | 0x0170 | | | | | | | | | | | | | | | | |
| 24 | 0x0180 | CC File Area | | | | | | | | | | | | | | | |
| 25 | 0x0190 | User Area | | | | | | | | | | | | | | | |
| 26 | 0x01A0 | User Area | | | | | | | | | | | | | | | |
| 27 | 0x01B0 | System Area | | | | | | | | | | | | | | | |
| 28 | 0x01C0 | | | | | | | | | | | | | | | | |
| 29 | 0x01D0 | | | | | | | | | | | | | | | | |
| 30 | 0x01E0 | | | | | | | | | | | | | | | | |
| 31 | 0x01F0 | | | | | | | | | | | | | | | | |

Fig 4-28 Memory map when NDEF is used

4.3.10.2 NDEF Tag Application Selection

This selection requires a SELECT command.

4.3.10.3 CC File

This selection requires a SELECT command.

While in CC file selection, CC file starts from the beginning of Block 24 (physical address 0x0180).

See Table 4-26 shows a setting example of the CC file.

Table 4-26 Example of the CC file

| Select address | Physical address | Size | Value | Contents | Remarks |
|-------------------|-------------------|-------|--------|--|---|
| 0x0000 ~0x0001 | 0x0180 ~0x0181 | 2Byte | 0x000F | CCLen (Length of CC file) | |
| 0x0002 | 0x0182 | 1Byte | 0x20 | Mapping Version | Please set 0x20 in this RFID. |
| 0x0003 ~0x0004 | 0x0183 ~0x0184 | 2Byte | 0x003B | MLe (The biggest response length of the Read command) | |
| 0x0005 ~0x0006 | 0x0185 ~0x0186 | 2Byte | 0x0034 | Mlc (The biggest response length of the Write command) | |
| 0x0007 | 0x0187 | 1Byte | 0x04 | T field of the NDEF File Control TLV | |
| 0x0008 | 0x0188 | 1Byte | 0x06 | L field of the NDEF File Control TLV | |
| 0x0009 ~0x000A | 0x0189 ~0x018A | 6Byte | 0x0103 | V field of the NDEF File Control TLV | File ID Please set 0x 0103 in this RFID. |
| 0x000B ~0x000C | 0x018B ~0x018C | | 0x0032 | | The biggest NDEF size |
| 0x000D | 0x018D | | 0x00 | | Read access condition |
| 0x000E | 0x018E | | 0x00 | | Write access condition |

4.3.10.4 NDEF File

This selection requires a SELECT command.

Table 4-27 shows empty NDEF file as a setting example of the NDEF file.

Table 4-27 Setting example of the NDEF file(when NDEF file is empty)

| Select address | Physical address | Size | Value | Contents | Remarks |
|-------------------|-------------------|-------|----------|----------------------------|-------------------------------------|
| 0x0000 ~0x0001 | 0x000C ~0x000D | 2Byte | 0x0003 | NLEN (NDEF message length) | The size of NLEN is 2Byte fixation. |
| 0x0002 ~0x0004 | 0x0010 ~0x0012 | 3Byte | 0xD00000 | NDEF message | The value shows an empty message |

The access to the NDEF file in the NDEF file choice state, I link NLEN and NDEF message and, only other than only NLEN or NDEF message, can access it by 1 command.

In the NDEF file choice state, physical address 0x000C of Block0 the NDEF file top, the top (physical address 0x0010) becomes address 0x0002 of the NDEF file.) of Block1. In other words, the NLEN field of the NDEF file is placed in 0x000C – 0x000D of the physical address, and the NDEF message field is placed by 0x0010 of the physical address.

Chapter 5 Interrupt Generation Function

5.1 Interrupt Source

This tag module is not NIRQ terminal is output to the external. Interrupt function is not supported.

Chapter 6 Electrical characteristics



| | |
|--|--|
| | |
| | |

Electrical characteristics

| | |
|------------------------|---|
| PART No. : MN63Y3212N4 | |
| PACKAGE CODE No. | TAG3-DIA30-A (Contactless Coin-tag module) |

| | | | |
|--|----------------------------|--|--|
| | Electrical characteristics | | |
| | | | |
| | | | |

Attention

The technical information described in this document is intended only to show the main characteristics and application circuit examples of the product. No license is granted in and to any intellectual property right or other right owned by Panasonic Corporation or any other company. Therefore, no responsibility is assumed by our company as to the infringement upon any such right owned by any other company which may arise as a result of the use of technical information described in this document.



| | | |
|--|----------------------------|--|
| | Electrical characteristics | |
| | | |
| | | |

| | |
|-------------|--|
| Structure | RF Tag Module with CMOS Type LSI / 4Kbit Non-volatile memory |
| Application | Digital AV devices, Home Appliances, Portable devices, etc. |
| Function | Dual interface RFID |

A. Absolute Maximum Ratings Note 1)

$V_{SS} = 0\text{ V}$

| Item | Symbol | Rating | Unit |
|--|-----------|---------------|------|
| A1 Power supply <small>Note 2)</small> | V_{DDA} | - 0.3 ~ + 4.6 | V |
| A2 Voltage antenna terminals swing (VB Peak to peak) <small>Note3)</small> | V_{CBA} | 30 | V |
| A3 Storage temperature <small>Note 4)</small> | T_{stg} | -25 ~ 80 | °C |
| A4 Operating ambient temperature | T_{opr} | -20 ~ 80 | °C |

Note 1) Absolute Maximum Ratings are limit values not to destroy LSI mounted on the tag module and are not to guarantee operation.

Note 2) V_{DDA} is not a terminal for external supply. This is the power supply voltage generated in the LSI by RF communication.

Note 3) Definition of Voltage antenna terminals swing (V_{CBA})

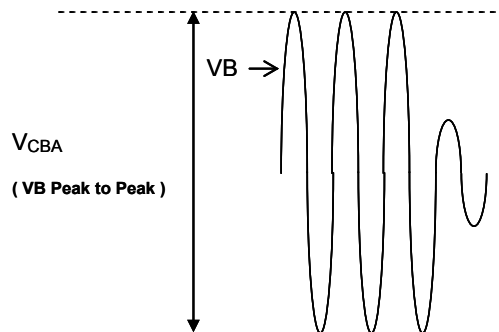

Note 4) It is recommended that a data write to Non-volatile memory be performed after reflow soldering (Otherwise, due to very high temperature in reflow soldering, Non-volatile memory data retention is not guaranteed.)

| |
|--|
| |
|--|

| | | | |
|--|----------------------------|--|--|
| | Electrical characteristics | | |
| | | | |
| | | | |

B. Operating Conditions

- 1) Communication method : Dielectric wireless communication method
- 2) RF Interface :
 - Compliant with JIS X6319-4 (212kbps/424kbps)
 - Compliant with ISO/IEC 14443 TypeB (106kbps/212kbps)
- 3) Operating frequency : 13.56MHz
- 4) Storage temperature : -25 ~ 75 °C
- 5) Operating ambient temperature : -20 ~ 55 °C

| | | |
|--|----------------------------|--|
| | Electrical characteristics | |
| | | |
| | | |

C. AC characteristics

RF interface

Ta = -20 °C ~ 55 °C, V_{SS} = 0 V

| Item | Symbol | Condition | Limits | | | Unit | |
|------|-----------------------------|-----------|--|-----|-----|------|---|
| | | | Min | Typ | Max | | |
| C1 | Modulation index of command | m | JISX6319-4 RF interface specification Communication rate of 212kbps | 4.0 | - | 14 | % |
| | | | ISO/IEC14443 RF interface specification Communication rate of 106kbps | 8 | - | 14 | % |

Note 5) See each standard For more information about the RF interface.

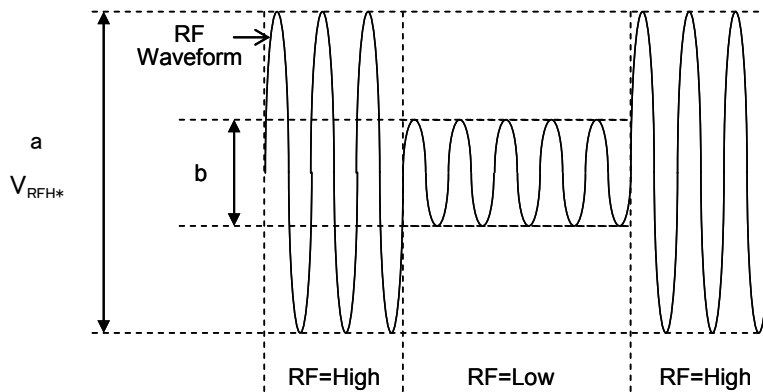

Modulation Factor $m = \frac{a-b}{a+b}$

The RF waveform is measured with a calibration coil specified in ISO/IEC 10373-6.

Fig. 1

Revision History

Revision History of MN63Y3212N4 user's manual is shown below

Revised on Jan 29, 2015

| Purpose | Version 1.0 | | | Version x.x | | |
|---------|-------------|---------|---------------------|-------------|---------|----------|
| | Page | Section | Comments | Page | Section | Comments |
| | | | Provisional version | - | - | - |

Request for your special attention and precautions in using the technical information and semiconductors described in this book

- (1) If any of the products or technical information described in this book is to be exported or provided to non-residents, the laws and regulations of the exporting country, especially, those with regard to security export control, must be observed.
- (2) The technical information described in this book is intended only to show the main characteristics and application circuit examples of the products. No license is granted in and to any intellectual property right or other right owned by Panasonic Corporation or any other company. Therefore, no responsibility is assumed by our company as to the infringement upon any such right owned by any other company which may arise as a result of the use of technical information described in this book.
- (3) The products described in this book are intended to be used for general applications (such as office equipment, communications equipment, measuring instruments and household appliances), or for specific applications as expressly stated in this book.
Consult our sales staff in advance for information on the following applications:
 - Special applications (such as for airplanes, aerospace, automotive equipment, traffic signaling equipment, combustion equipment, life support systems and safety devices) in which exceptional quality and reliability are required, or if the failure or malfunction of the products may directly jeopardize life or harm the human body.It is to be understood that our company shall not be held responsible for any damage incurred as a result of or in connection with your using the products described in this book for any special application, unless our company agrees to your using the products in this book for any special application.
- (4) The products and product specifications described in this book are subject to change without notice for modification and/or improvement. At the final stage of your design, purchasing, or use of the products, therefore, ask for the most up-to-date Product Standards in advance to make sure that the latest specifications satisfy your requirements.
- (5) When designing your equipment, comply with the range of absolute maximum rating and the guaranteed operating conditions (operating power supply voltage and operating environment etc.). Especially, please be careful not to exceed the range of absolute maximum rating on the transient state, such as power-on, power-off and mode-switching. Otherwise, we will not be liable for any defect which may arise later in your equipment.
Even when the products are used within the guaranteed values, take into the consideration of incidence of break down and failure mode, possible to occur to semiconductor products. Measures on the systems such as redundant design, arresting the spread of fire or preventing glitch are recommended in order to prevent physical injury, fire, social damages, for example, by using the products.
- (6) Comply with the instructions for use in order to prevent breakdown and characteristics change due to external factors (ESD, EOS, thermal stress and mechanical stress) at the time of handling, mounting or at customer's process. When using products for which damp-proof packing is required, satisfy the conditions, such as shelf life and the elapsed time since first opening the packages.
- (7) This book may be not reprinted or reproduced whether wholly or partially, without the prior written permission of our company.

Mouser Electronics

Authorized Distributor

Click to View Pricing, Inventory, Delivery & Lifecycle Information:

[Panasonic:](#)

[MN63Y3212N4](#)