

# Z0103MN, Z0107MN, Z0109MN

## Sensitive Gate Triac Series

### Silicon Bidirectional Thyristors

Designed for use in solid state relays, MPU interface, TTL logic and other light industrial or consumer applications. Supplied in surface mount package for use in automated manufacturing.

#### Features

- Sensitive Gate Trigger Current in Four Trigger Modes
- Blocking Voltage to 600 V
- Glass Passivated Surface for Reliability and Uniformity
- Surface Mount Package
- These are Pb-Free Devices

#### MAXIMUM RATINGS (T<sub>J</sub> = 25°C unless otherwise noted)

Rating	Symbol	Value	Unit
Peak Repetitive Off-State Voltage (Note 1) (Sine Wave, 50 to 60 Hz, Gate Open, T <sub>J</sub> = -40 to +125°C)	V <sub>DRM</sub> , V <sub>RRM</sub>	600	V
On-State Current RMS (T <sub>C</sub> = 80°C) (Full Sine Wave 50 to 60 Hz)	I <sub>T(RMS)</sub>	1.0	A
Peak Non-repetitive Surge Current (One Full Cycle Sine Wave, 60 Hz, T <sub>C</sub> = 25°C)	I <sub>TSM</sub>	8.0	A
Circuit Fusing Considerations (Pulse Width = 8.3 ms)	I <sup>2</sup> t	0.4	A <sup>2</sup> s
Average Gate Power (T <sub>C</sub> = 80°C, t ≤ 8.3 ms)	P <sub>G(AV)</sub>	1.0	W
Peak Gate Current (t ≤ 20 μs, T <sub>J</sub> = +125°C)	I <sub>GM</sub>	1.0	A
Operating Junction Temperature Range	T <sub>J</sub>	-40 to +125	°C
Storage Temperature Range	T <sub>stg</sub>	-40 to +150	°C

Stresses exceeding Maximum Ratings may damage the device. Maximum Ratings are stress ratings only. Functional operation above the Recommended Operating Conditions is not implied. Extended exposure to stresses above the Recommended Operating Conditions may affect device reliability.

1. V<sub>DRM</sub> and V<sub>RRM</sub> for all types can be applied on a continuous basis. Blocking voltages shall not be tested with a constant current source such that the voltage ratings of the devices are exceeded.

#### THERMAL CHARACTERISTICS

Characteristic	Symbol	Max	Unit
Thermal Resistance, Junction-to-Ambient PCB Mounted per Figure 1	R <sub>θJA</sub>	156	°C/W
Thermal Resistance, Junction-to-Tab Meas- ured on MT2 Tab Adjacent to Epoxy	R <sub>θJT</sub>	25	°C/W
Maximum Device Temperature for Soldering Purposes for 10 Secs Maximum	T <sub>L</sub>	260	°C



ON Semiconductor®

<http://onsemi.com>

**TRIAC**  
**1.0 AMPERE RMS**  
**600 VOLTS**

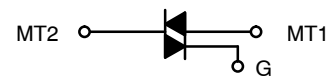

#### MARKING DIAGRAM

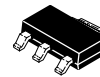

**SOT-223**  
**CASE 318E**  
**STYLE 11**

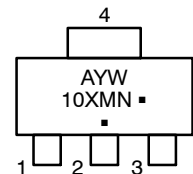

A = Assembly Location  
Y = Year  
W = Work Week  
10XMN = Device Code  
x = 3, 7, 9  
▪ = Pb-Free Package  
(Note: Microdot may be in either location)

#### PIN ASSIGNMENT

Pin	Assignment
1	Main Terminal 1
2	Main Terminal 2
3	Gate
4	Main Terminal 2

#### ORDERING INFORMATION

Device	Package	Shipping†
Z0103MNT1G	SOT-223 (Pb-Free)	1000/Tape & Reel
Z0107MNT1G	SOT-223 (Pb-Free)	1000/Tape & Reel
Z0109MNT1G	SOT-223 (Pb-Free)	1000/Tape & Reel

†For information on tape and reel specifications, including part orientation and tape sizes, please refer to our Tape and Reel Packaging Specification Brochure, BRD8011/D.

# Z0103MN, Z0107MN, Z0109MN

## ELECTRICAL CHARACTERISTICS (T<sub>C</sub> = 25°C unless otherwise noted; Electricals apply in both directions)

Characteristic	Symbol	Min	Typ	Max	Unit
----------------	--------	-----	-----	-----	------

### OFF CHARACTERISTICS

Peak Repetitive Blocking Current (V <sub>D</sub> = Rated V <sub>DRM</sub> , V <sub>RRM</sub> ; Gate Open)	T <sub>J</sub> = 25°C T <sub>J</sub> = +125°C	I <sub>DRM</sub> , I <sub>RRM</sub>	-	-	5.0 500	μA μA
--	--	-------------------------------------	---	---	------------	----------

### ON CHARACTERISTICS

Peak On-State Voltage (I <sub>TM</sub> = ± 1.4 A Peak; Pulse Width ≤ 2.0 ms, Duty Cycle ≤ 2.0%)		V <sub>TM</sub>	-	-	1.56	V
Gate Trigger Current (Continuous dc) (V <sub>D</sub> = 12 Vdc, R <sub>L</sub> = 30 Ohms) MT2(+), G(+) MT2(+), G(-) MT2(-), G(-) MT2(-), G(+)	Z0103MN	I <sub>GT</sub>	0.15 0.15 0.15 0.25	- - - -	3.0 3.0 3.0 5.0	mA
Gate Trigger Current (Continuous dc) (V <sub>D</sub> = 12 Vdc, R <sub>L</sub> = 30 Ohms) MT2(+), G(+) MT2(+), G(-) MT2(-), G(-) MT2(-), G(+)	Z0107MN	I <sub>GT</sub>	0.15 0.15 0.15 0.25	- - - -	5.0 5.0 5.0 7.0	mA
Gate Trigger Current (Continuous dc) (V <sub>D</sub> = 12 Vdc, R <sub>L</sub> = 30 Ohms) MT2(+), G(+) MT2(+), G(-) MT2(-), G(-) MT2(-), G(+)	Z0109MN	I <sub>GT</sub>	0.15 0.15 0.15 0.25	- - - -	10 10 10 10	mA
Latching Current (V <sub>D</sub> = 12 V, I <sub>G</sub> = 1.2 x I <sub>GT</sub> ) MT2(+), G(+) MT2(+), G(-) MT2(-), G(-) MT2(-), G(+)	Z0103MN	I <sub>L</sub>	- - - -	- - - -	7.0 15 7.0 7.0	mA
Latching Current (V <sub>D</sub> = 12 V, I <sub>G</sub> = 1.2 x I <sub>GT</sub> ) MT2(+), G(+) MT2(+), G(-) MT2(-), G(-) MT2(-), G(+)	Z0107MN	I <sub>L</sub>	- - - -	- - - -	10 20 10 10	mA
Latching Current (V <sub>D</sub> = 12 V, I <sub>G</sub> = 1.2 x I <sub>GT</sub> ) MT2(+), G(+) MT2(+), G(-) MT2(-), G(-) MT2(-), G(+)	Z0109MN	I <sub>L</sub>	- - - -	- - - -	15 25 15 15	mA
Gate Trigger Voltage (Continuous dc) (V <sub>D</sub> = 12 Vdc, R <sub>L</sub> = 30 Ohms)		V <sub>GT</sub>	-	-	1.3	V
Gate Non-Trigger Voltage (V <sub>D</sub> = 12 V, R <sub>L</sub> = 30 Ohms, T <sub>J</sub> = 125°C) All Four Quadrants		V <sub>GD</sub>	0.2	-	-	V
Holding Current (V <sub>D</sub> = 12 Vdc, Initiating Current = 50 mA, Gate Open)	(Z0103MA) (Z0107MA, Z0109MA)	I <sub>H</sub>	- -	- -	7.0 10	mA

### DYNAMIC CHARACTERISTICS

Rate of Change of Commutating Current (V <sub>D</sub> = 400 V, I <sub>TM</sub> = 0.84 A, Commutating dv/dt = 1.5 V/μs, Gate Open, T <sub>J</sub> = 110°C, f = 250 Hz, with Snubber)		di/dt(c)	1.6	-	-	A/ms
Critical Rate of Rise of Off-State Voltage (V <sub>D</sub> = 67% Rated V <sub>DRM</sub> , Exponential Waveform, Gate Open, T <sub>J</sub> = 110°C)	Z0103MN Z0107MN Z0109MN	dv/dt	10 20 50	30 60 75	- - -	V/μs
Repetitive Critical Rate of Rise of On-State Current, T <sub>J</sub> = 125°C Pulse Width = 20 μs, I <sub>PKmax</sub> = 15 A, diG/dt = 1 A/μs, f = 60 Hz		di/dt	-	-	20	A/μs

# Z0103MN, Z0107MN, Z0109MN

## Voltage Current Characteristic of Triacs (Bidirectional Device)

Symbol	Parameter
$V_{DRM}$	Peak Repetitive Forward Off State Voltage
$I_{DRM}$	Peak Forward Blocking Current
$V_{RRM}$	Peak Repetitive Reverse Off State Voltage
$I_{RRM}$	Peak Reverse Blocking Current
$V_{TM}$	Maximum On State Voltage
$I_H$	Holding Current

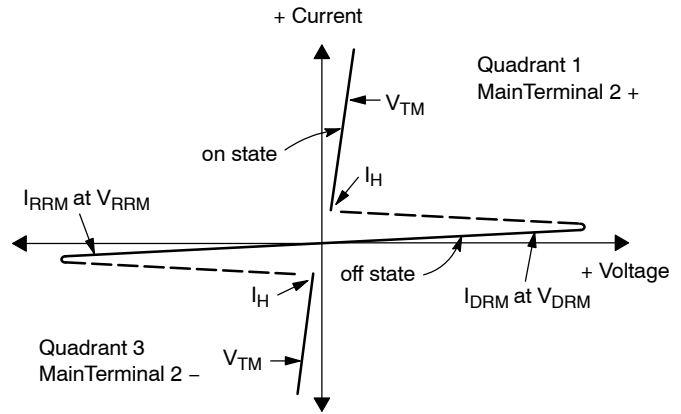

### Quadrant Definitions for a Triac

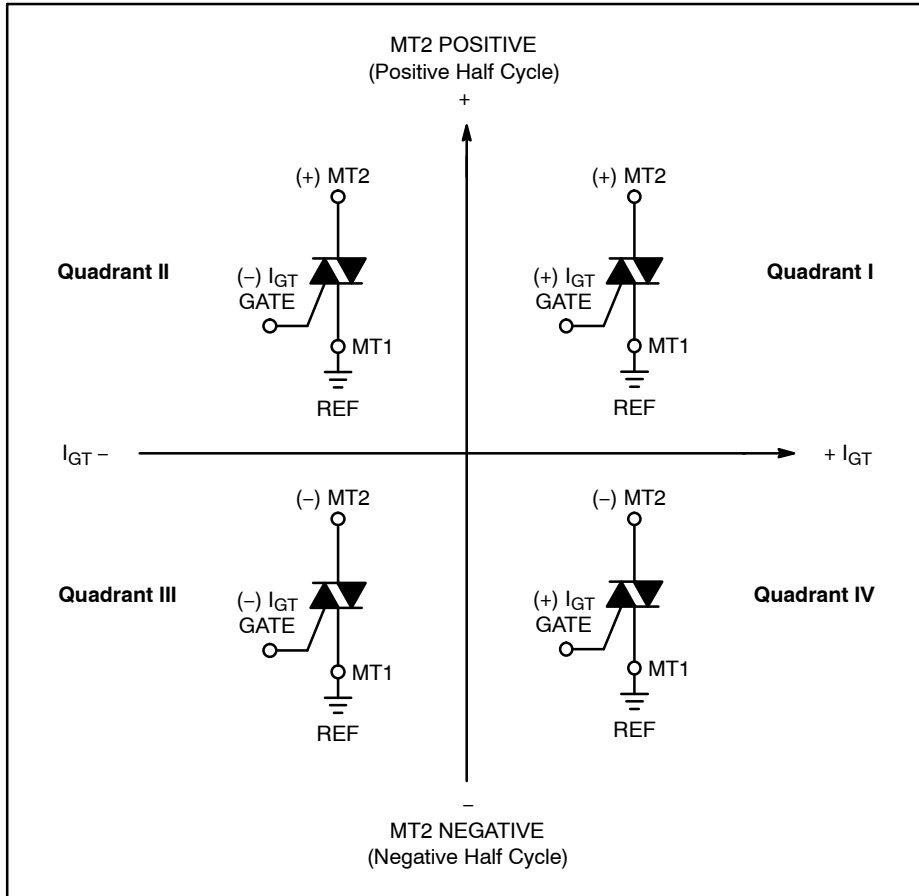

All polarities are referenced to MT1.

With in-phase signals (using standard AC lines) quadrants I and III are used.

**Z0103MN, Z0107MN, Z0109MN**

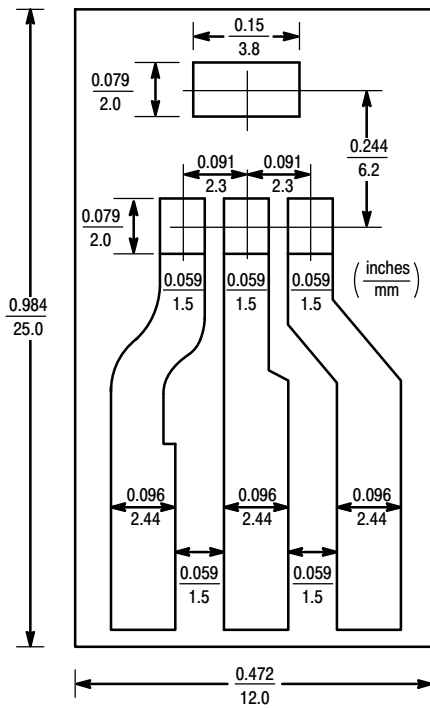

BOARD MOUNTED VERTICALLY IN CINCH 8840 EDGE CONNECTOR.  
 BOARD THICKNESS = 65 MIL, FOIL THICKNESS = 2.5 MIL  
 MATERIAL: G10 FIBERGLASS BASE EPOXY

**Figure 1. PCB for Thermal Impedance and Power Testing of SOT-223**

# Z0103MN, Z0107MN, Z0109MN

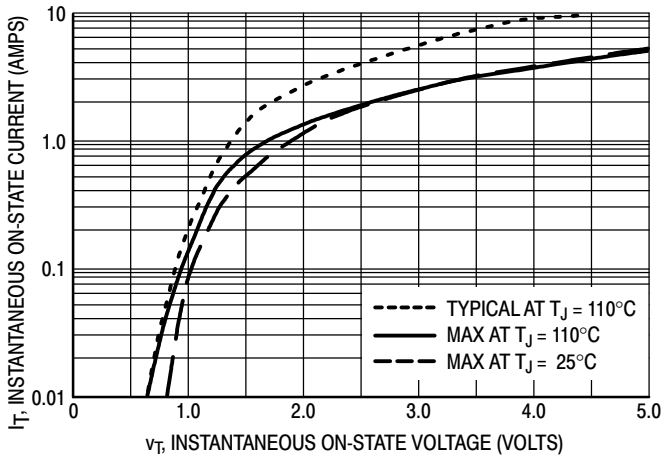

**Figure 2. On-State Characteristics**

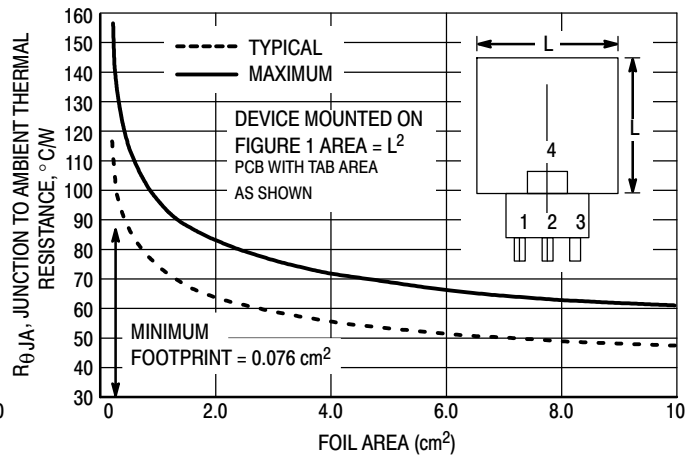

**Figure 3. Junction to Ambient Thermal Resistance versus Copper Tab Area**

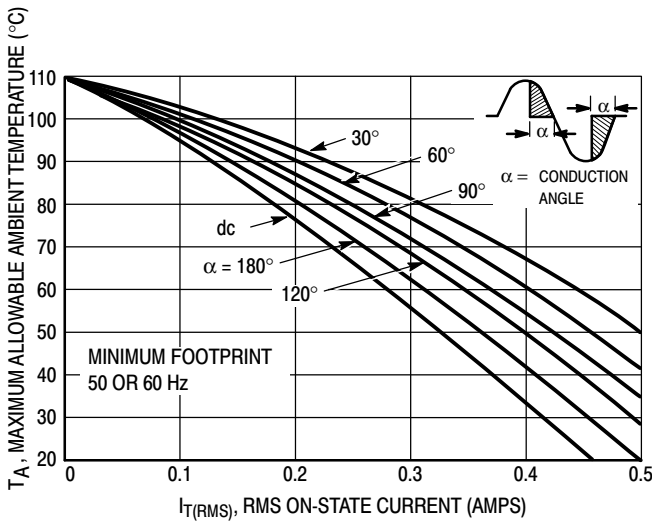

**Figure 4. Current Derating, Minimum Pad Size Reference: Ambient Temperature**

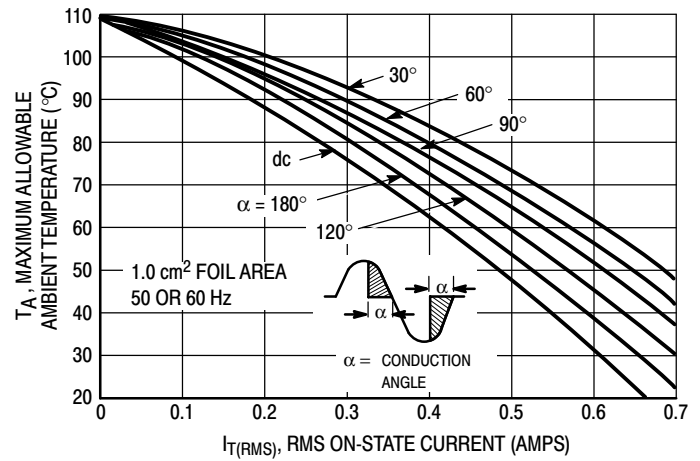

**Figure 5. Current Derating, 1.0 cm Square Pad Reference: Ambient Temperature**

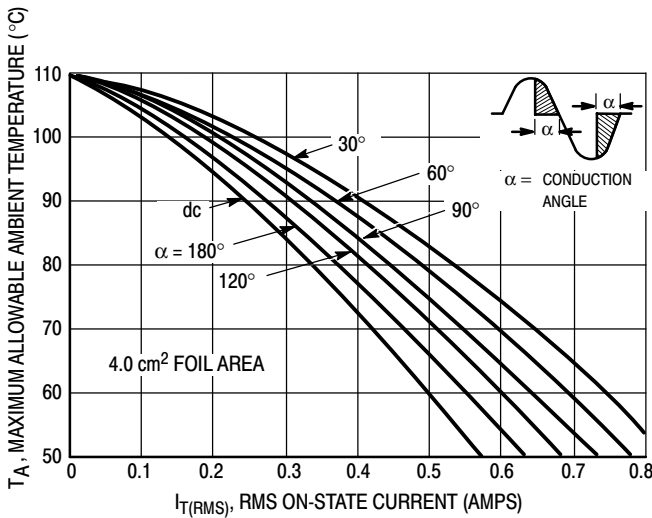

**Figure 6. Current Derating, 2.0 cm Square Pad Reference: Ambient Temperature**

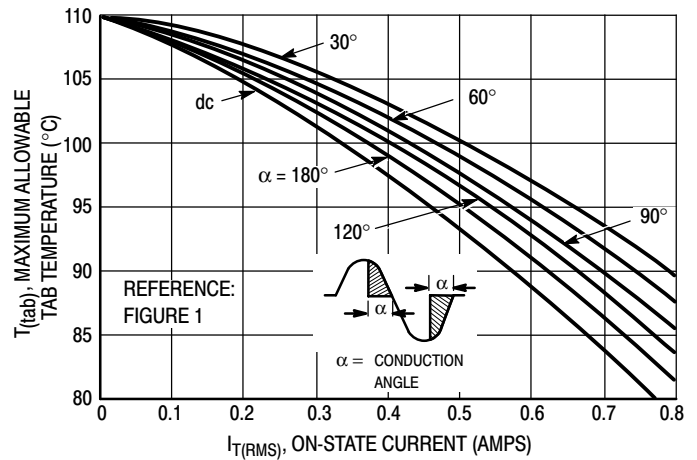

**Figure 7. Current Derating Reference: MT2 Tab**

# Z0103MN, Z0107MN, Z0109MN

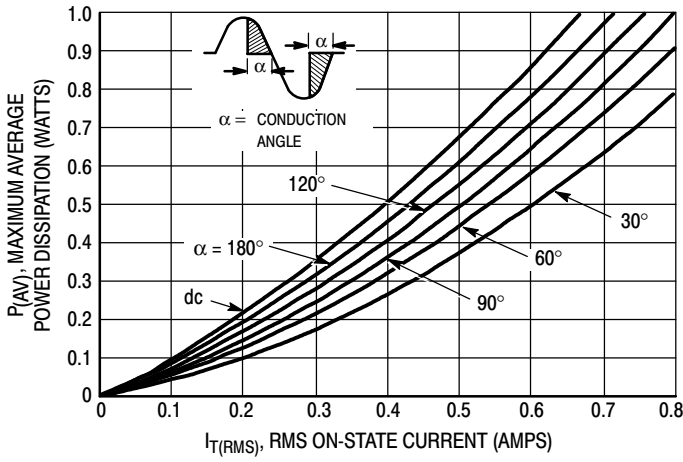

Figure 8. Power Dissipation

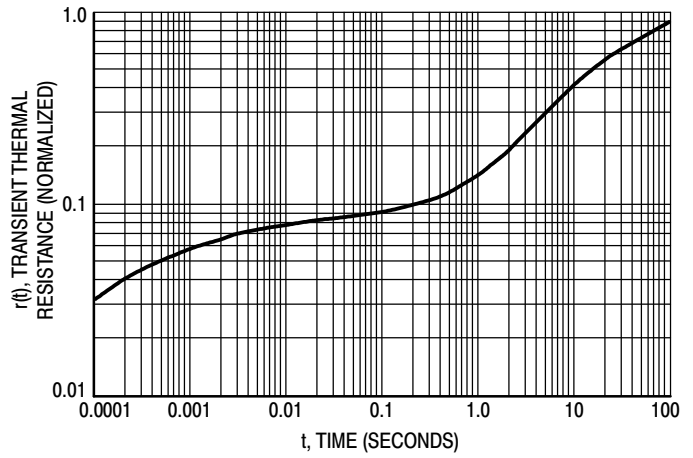
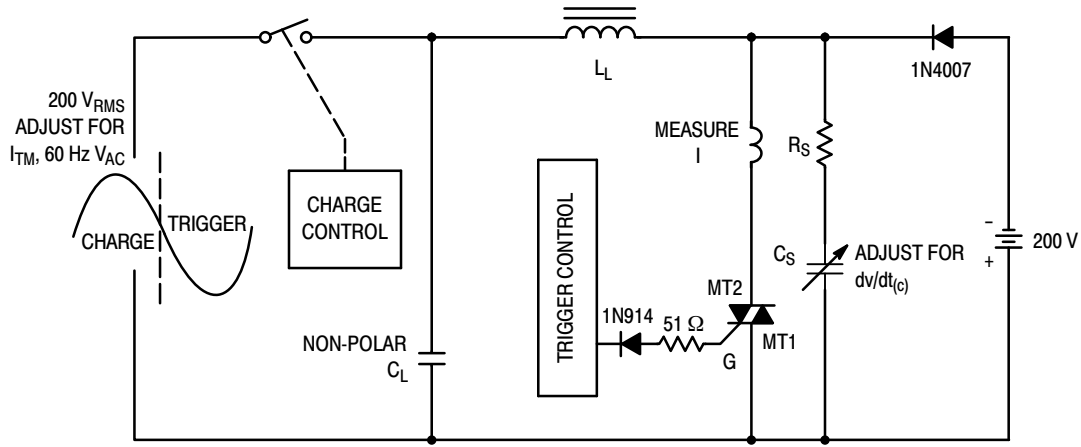

Figure 9. Thermal Response, Device Mounted on Figure 1 Printed Circuit Board



Note: Component values are for verification of rated  $(dv/dt)_c$ . See AN1048 for additional information.

Figure 10. Simplified Test Circuit to Measure the Critical Rate of Rise of Commutating Voltage  $(dv/dt)_c$

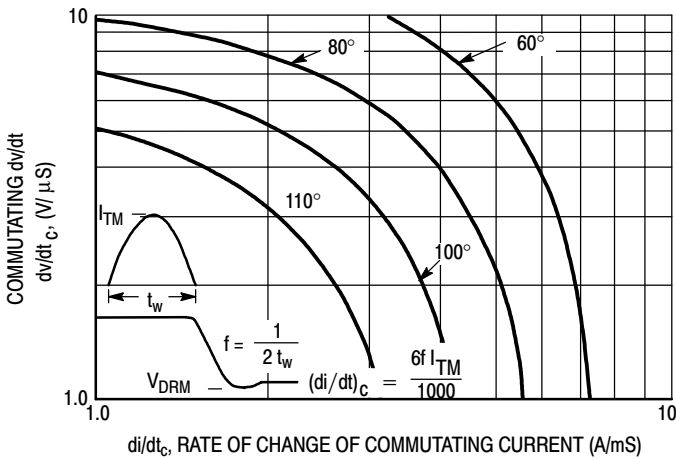

Figure 11. Typical Commutating  $dv/dt$  versus Current Crossing Rate and Junction Temperature

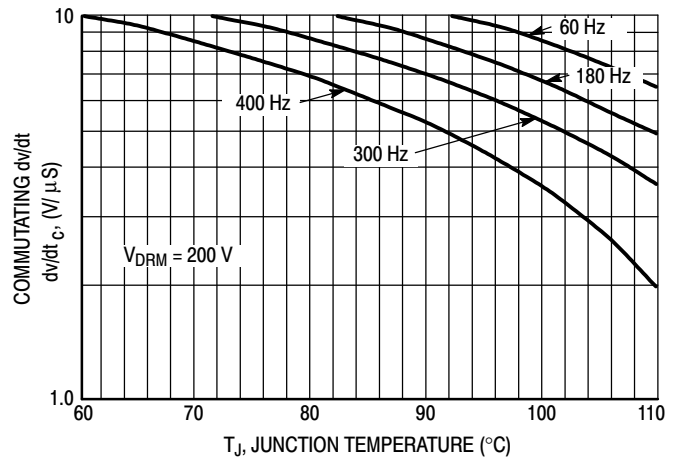

Figure 12. Typical Commutating  $dv/dt$  versus Junction Temperature at 0.8 Amps RMS

Z0103MN, Z0107MN, Z0109MN

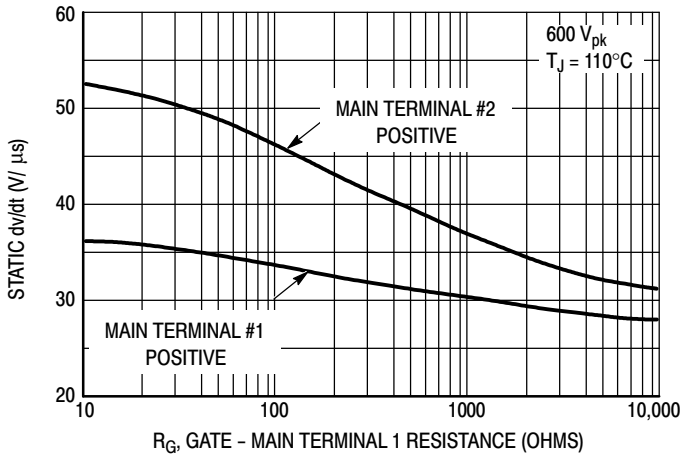

Figure 13. Exponential Static dv/dt versus Gate - Main Terminal 1 Resistance

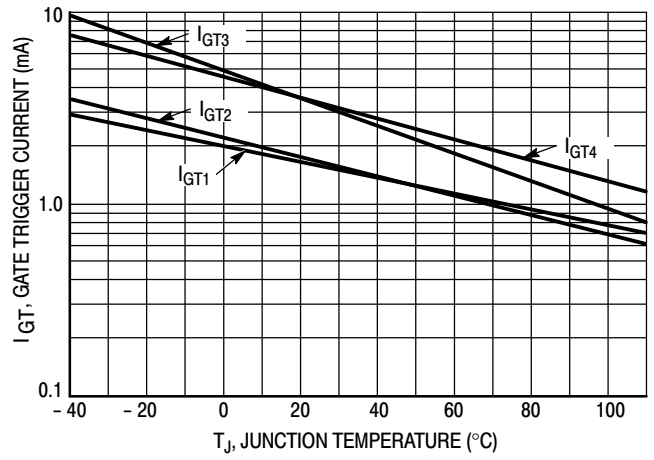

Figure 14. Typical Gate Trigger Current Variation

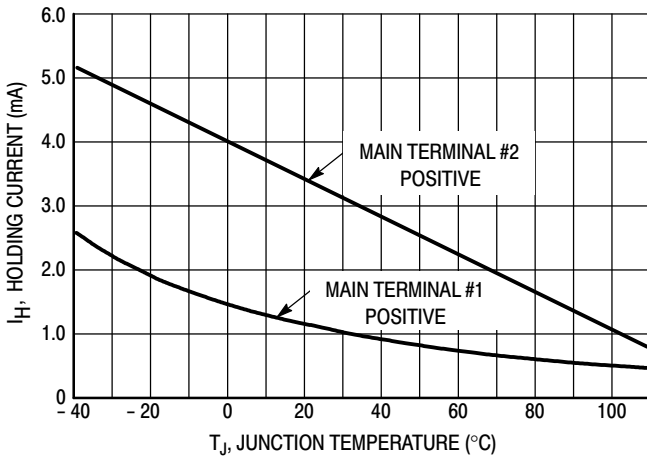

Figure 15. Typical Holding Current Variation

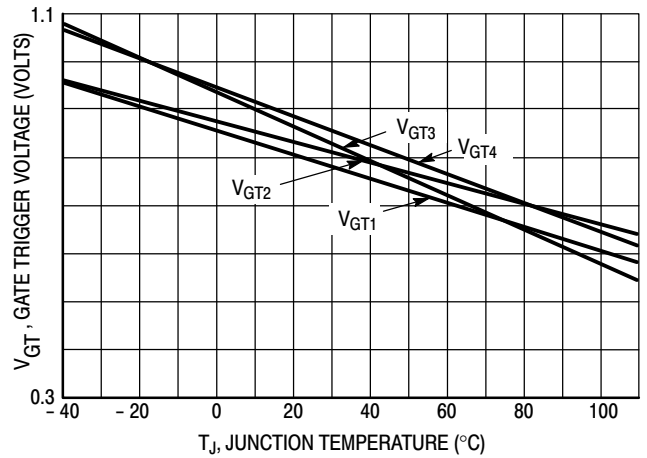
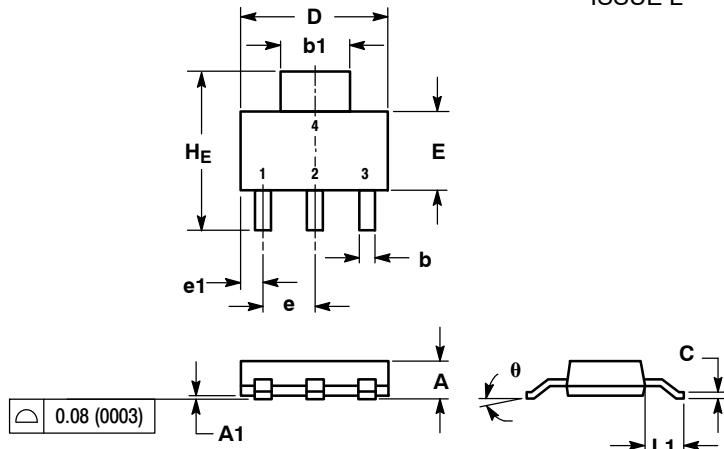

Figure 16. Gate Trigger Voltage Variation

# Z0103MN, Z0107MN, Z0109MN

## PACKAGE DIMENSIONS

SOT-223 (TO-261)  
CASE 318E-04  
ISSUE L



- NOTES:  
1. DIMENSIONING AND TOLERANCING PER ANSI Y14.5M, 1982.  
2. CONTROLLING DIMENSION: INCH.

DIM	MILLIMETERS			INCHES		
	MIN	NOM	MAX	MIN	NOM	MAX
A	1.50	1.63	1.75	0.060	0.064	0.068
A1	0.02	0.06	0.10	0.001	0.002	0.004
b	0.60	0.75	0.89	0.024	0.030	0.035
b1	2.90	3.06	3.20	0.115	0.121	0.126
c	0.24	0.29	0.35	0.009	0.012	0.014
D	6.30	6.50	6.70	0.249	0.256	0.263
E	3.30	3.50	3.70	0.130	0.138	0.145
e	2.20	2.30	2.40	0.087	0.091	0.094
e1	0.85	0.94	1.05	0.033	0.037	0.041
L1	1.50	1.75	2.00	0.060	0.069	0.078
HE	6.70	7.00	7.30	0.264	0.276	0.287
θ	0°	-	10°	0°	-	10°

STYLE 11:  
PIN 1. MT 1  
2. MT 2  
3. GATE  
4. MT 2

## SOLDERING FOOTPRINT\*

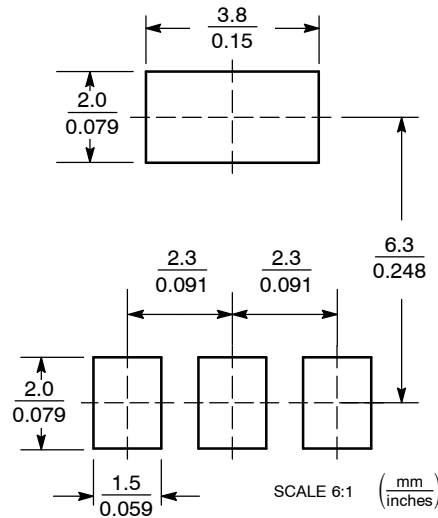

\*For additional information on our Pb-Free strategy and soldering details, please download the ON Semiconductor Soldering and Mounting Techniques Reference Manual, SOLDERRM/D.

ON Semiconductor and are registered trademarks of Semiconductor Components Industries, LLC (SCILLC). SCILLC reserves the right to make changes without further notice to any products herein. SCILLC makes no warranty, representation or guarantee regarding the suitability of its products for any particular purpose, nor does SCILLC assume any liability arising out of the application or use of any product or circuit, and specifically disclaims any and all liability, including without limitation special, consequential or incidental damages. "Typical" parameters which may be provided in SCILLC data sheets and/or specifications can and do vary in different applications and actual performance may vary over time. All operating parameters, including "Typicals" must be validated for each customer application by customer's technical experts. SCILLC does not convey any license under its patent rights nor the rights of others. SCILLC products are not designed, intended, or authorized for use as components in systems intended for surgical implant into the body, or other applications intended to support or sustain life, or for any other application in which the failure of the SCILLC product could create a situation where personal injury or death may occur. Should Buyer purchase or use SCILLC products for any such unintended or unauthorized application, Buyer shall indemnify and hold SCILLC and its officers, employees, subsidiaries, affiliates, and distributors harmless against all claims, costs, damages, and expenses, and reasonable attorney fees arising out of, directly or indirectly, any claim of personal injury or death associated with such unintended or unauthorized use, even if such claim alleges that SCILLC was negligent regarding the design or manufacture of the part. SCILLC is an Equal Opportunity/Affirmative Action Employer. This literature is subject to all applicable copyright laws and is not for resale in any manner.

## PUBLICATION ORDERING INFORMATION

LITERATURE FULFILLMENT:  
Literature Distribution Center for ON Semiconductor  
P.O. Box 5163, Denver, Colorado 80217 USA  
Phone: 303-675-2175 or 800-344-3860 Toll Free USA/Canada  
Fax: 303-675-2176 or 800-344-3867 Toll Free USA/Canada  
Email: orderlit@onsemi.com

N. American Technical Support: 800-282-9855 Toll Free  
USA/Canada  
Europe, Middle East and Africa Technical Support:  
Phone: 421 33 790 2910  
Japan Customer Focus Center  
Phone: 81-3-5773-3850

ON Semiconductor Website: [www.onsemi.com](http://www.onsemi.com)  
Order Literature: <http://www.onsemi.com/orderlit>

For additional information, please contact your local Sales Representative



# Mouser Electronics

Authorized Distributor

Click to View Pricing, Inventory, Delivery & Lifecycle Information:

[ON Semiconductor:](#)

[Z0103MNT1G](#) [Z0107MNT1G](#) [Z0109MNT1G](#)