

NTK3139P

Power MOSFET

-20 V, -780 mA, Single P-Channel with ESD Protection, SOT-723



ON Semiconductor®

<http://onsemi.com>

Features

- P-channel Switch with Low $R_{DS(on)}$
- 44% Smaller Footprint and 38% Thinner than SC-89
- Low Threshold Levels Allowing 1.5 V $R_{DS(on)}$ Rating
- Operated at Low Logic Level Gate Drive
- These Devices are Pb-Free, Halogen Free/BFR Free and are RoHS Compliant

Applications

- Load/Power Switching
- Interfacing, Logic Switching
- Battery Management for Ultra Small Portable Electronics

MAXIMUM RATINGS ($T_J = 25^\circ\text{C}$ unless otherwise stated)

Parameter		Symbol	Value	Unit	
Drain-to-Source Voltage		V_{DSS}	-20	V	
Gate-to-Source Voltage		V_{GS}	± 6	V	
Continuous Drain Current (Note 1)	Steady State	I_D	$T_A = 25^\circ\text{C}$	-780	mA
			$T_A = 85^\circ\text{C}$	-570	
	$t \leq 5 \text{ s}$	$T_A = 25^\circ\text{C}$	-870		
Power Dissipation (Note 1)	Steady State	P_D	$T_A = 25^\circ\text{C}$	450	mW
	$t \leq 5 \text{ s}$		550		
Continuous Drain Current (Note 2)	Steady State	I_D	$T_A = 25^\circ\text{C}$	-660	mA
			$T_A = 85^\circ\text{C}$	-480	
			$T_A = 25^\circ\text{C}$	P_D	
Pulsed Drain Current	$t_p = 10 \mu\text{s}$	I_{DM}	-1.2	A	
Operating Junction and Storage Temperature		T_J, T_{STG}	-55 to 150	$^\circ\text{C}$	
Lead Temperature for Soldering Purposes (1/8" from case for 10 s)		T_L	260	$^\circ\text{C}$	

Stresses exceeding Maximum Ratings may damage the device. Maximum Ratings are stress ratings only. Functional operation above the Recommended Operating Conditions is not implied. Extended exposure to stresses above the Recommended Operating Conditions may affect device reliability.

1. Surface mounted on FR4 board using 1 in sq pad size (Cu area = 1.127 in sq [1 oz] including traces)
2. Surface mounted on FR4 board using the minimum recommended pad size

$V_{(BR)DSS}$	$R_{DS(on)}$ TYP	I_D Max
-20 V	0.38 Ω @ -4.5 V	-780 mA
	0.52 Ω @ -2.5 V	-660 mA
	0.70 Ω @ -1.8 V	-100 mA
	0.95 Ω @ -1.5 V	-100 mA

SOT-723 (3-LEAD)

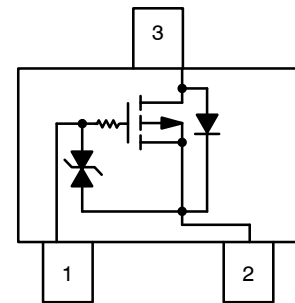

Top View

- 1 - Gate
- 2 - Source
- 3 - Drain

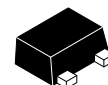

SOT-723
CASE 631AA
STYLE 5

MARKING DIAGRAM

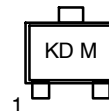

- KD = Specific Device Code
- M = Date Code

ORDERING INFORMATION

Device	Package	Shipping†
NTK3139PT1G	SOT-723 Pb-Free	4000 / Tape & Reel
NTK3139PT1H		
NTK3139PT5G		
NTK3139PT5H	8000 / Tape & Reel	

†For information on tape and reel specifications, including part orientation and tape sizes, please refer to our Tape and Reel Packaging Specification Brochure, BRD8011/D.

NTK3139P

THERMAL RESISTANCE RATINGS

Parameter	Symbol	Max	Unit
Junction-to-Ambient – Steady State (Note 3)	$R_{\theta JA}$	280	°C/W
Junction-to-Ambient – $t = 5$ s (Note 3)	$R_{\theta JA}$	228	
Junction-to-Ambient – Steady State Minimum Pad (Note 4)	$R_{\theta JA}$	400	

3. Surface mounted on FR4 board using 1 in sq pad size (Cu area = 1.127 in sq [1 oz] including traces)
 4. Surface mounted on FR4 board using the minimum recommended pad size

MOSFET ELECTRICAL CHARACTERISTICS ($T_J = 25^\circ\text{C}$ unless otherwise specified)

Parameter	Symbol	Test Condition	Min	Typ	Max	Unit
-----------	--------	----------------	-----	-----	-----	------

OFF CHARACTERISTICS

Drain-to-Source Breakdown Voltage	$V_{(BR)DSS}$	$V_{GS} = 0$ V, $I_D = -250$ μA	-20			V
Drain-to-Source Breakdown Voltage Temperature Coefficient	$V_{(BR)DSS}/T_J$	$I_D = -250$ μA , Reference to 25°C		-16.5		mV/°C
Zero Gate Voltage Drain Current	I_{DSS}	$V_{GS} = 0$ V, $V_{DS} = -16$ V	$T_J = 25^\circ\text{C}$		-1.0	μA
			$T_J = 125^\circ\text{C}$		-2.0	
Gate-to-Source Leakage Current	I_{GSS}	$V_{DS} = 0$ V, $V_{GS} = \pm 4.5$ V			± 2.0	μA

ON CHARACTERISTICS (Note 5)

Gate Threshold Voltage	$V_{GS(TH)}$	$V_{GS} = V_{DS}$, $I_D = -250$ μA	-0.45		-1.2	V
Negative Threshold Temperature Coefficient	$V_{GS(TH)}/T_J$			2.4		mV/°C
Drain-to-Source On Resistance	$R_{DS(on)}$	$V_{GS} = -4.5$ V, $I_D = -780$ mA		0.38	0.48	Ω
				0.52	0.67	
				0.70	0.95	
				0.95	2.20	
Forward Transconductance	g_{FS}	$V_{DS} = -10$ V, $I_D = -540$ mA		1.2		S

CHARGES, CAPACITANCES AND GATE RESISTANCE

Input Capacitance	C_{ISS}	$V_{GS} = 0$ V, $f = 1$ MHz, $V_{DS} = -16$ V		113	170	pF
Output Capacitance	C_{OSS}			15	25	
Reverse Transfer Capacitance	C_{RSS}			9.0	15	

SWITCHING CHARACTERISTICS, $V_{GS} = 4.5$ V (Note 6)

Turn On Delay Time	$t_{d(ON)}$	$V_{GS} = -4.5$ V, $V_{DS} = -10$ V, $I_D = -200$ mA, $R_G = 10$ Ω		9.0		ns
Rise Time	t_r			5.8		
TurnOff Delay Time	$t_{d(OFF)}$			32.7		
Fall Time	t_f			20.3		

DRAIN SOURCE DIODE CHARACTERISTICS

Forward Diode Voltage	V_{SD}	$V_{GS} = 0$ V, $I_S = -350$ mA	$T_J = 25^\circ\text{C}$		-0.8	-1.2	V
Reverse Recovery Time	t_{RR}	$V_{GS} = 0$ V, $dI_{SD}/dt = 100$ A/ μs , $I_S = -1.0$ A, $V_{DD} = -20$ V			13.2		ns
Charge Time	t_a				11.8		
Discharge Time	t_b				1.4		
Reverse Recovery Charge	Q_{RR}				5.0		nC

5. Pulse Test: pulse width = 300 μs , duty cycle = 2%
 6. Switching characteristics are independent of operating junction temperatures

TYPICAL CHARACTERISTICS

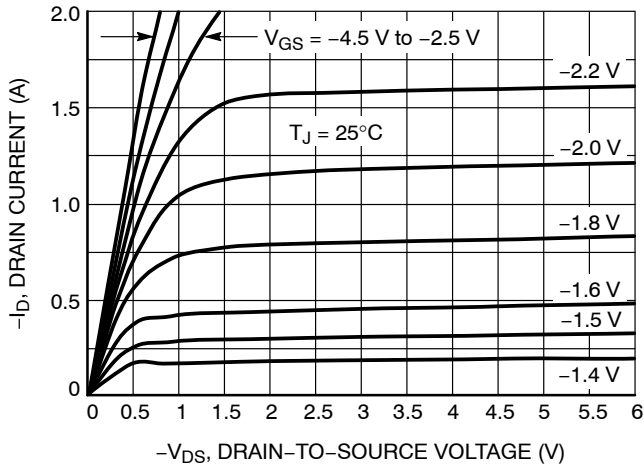

Figure 1. On-Region Characteristics

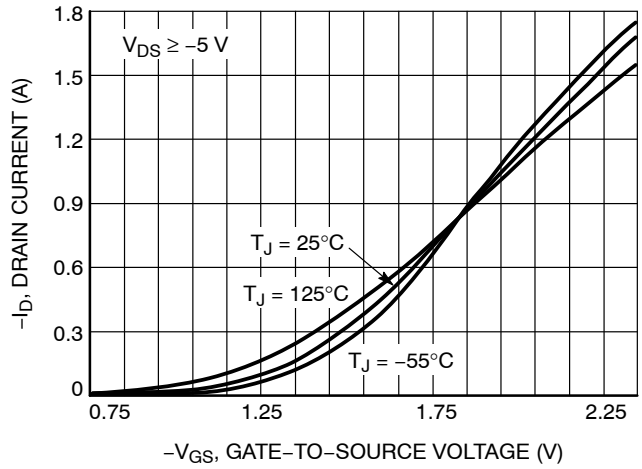

Figure 2. Transfer Characteristics

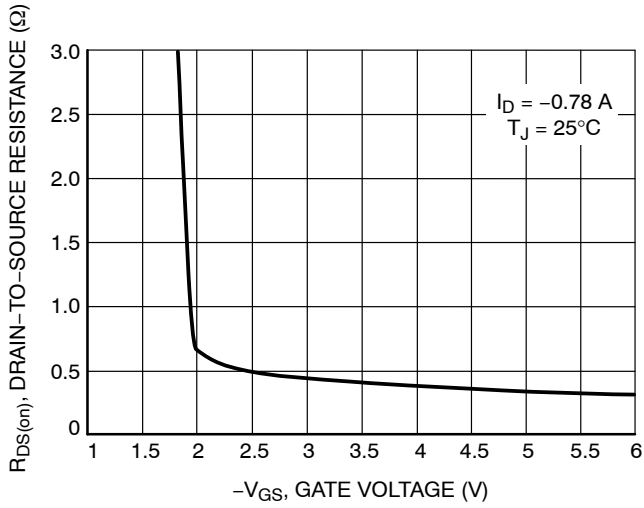

Figure 3. On-Resistance vs. Gate-to-Source Voltage

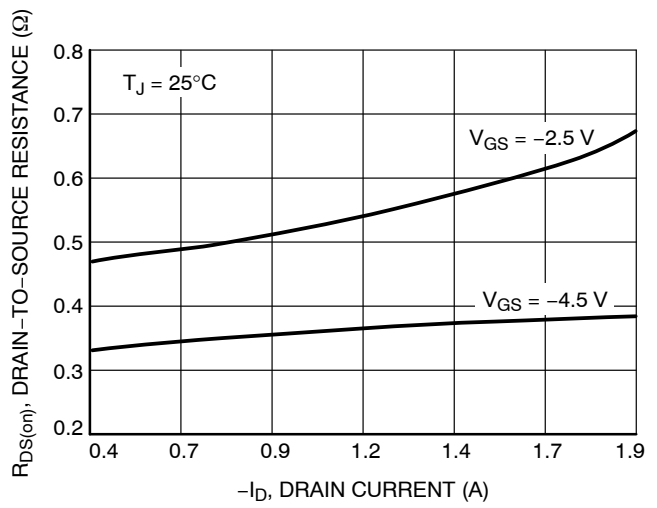

Figure 4. On-Resistance vs. Drain Current and Gate Voltage

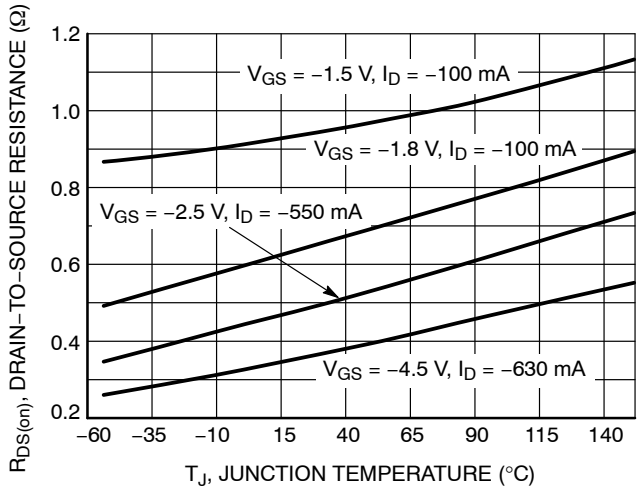

Figure 5. On-Resistance Variation with Temperature

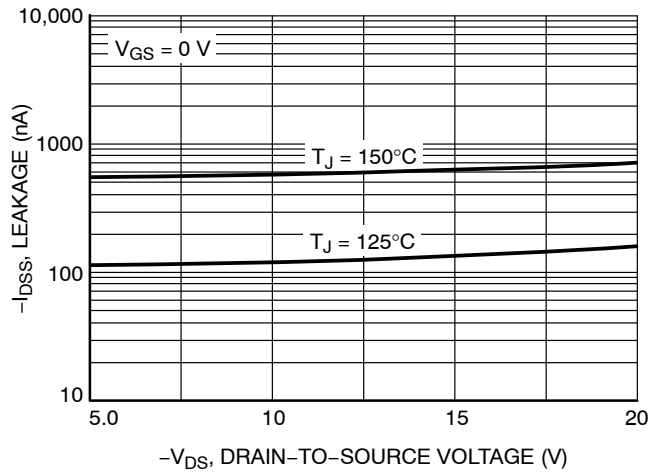

Figure 6. Drain-to-Source Leakage Current vs. Voltage

TYPICAL CHARACTERISTICS

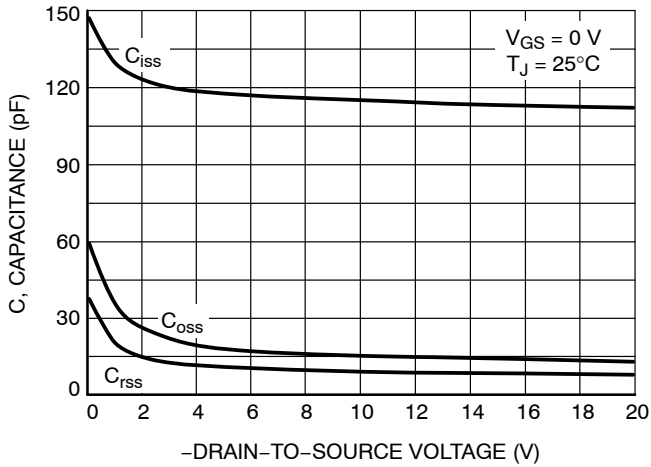

Figure 7. Capacitance Variation

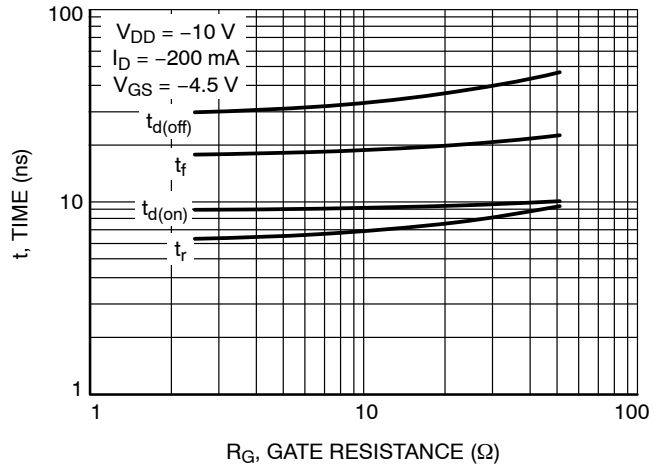

Figure 8. Resistive Switching Time Variation vs. Gate Resistance

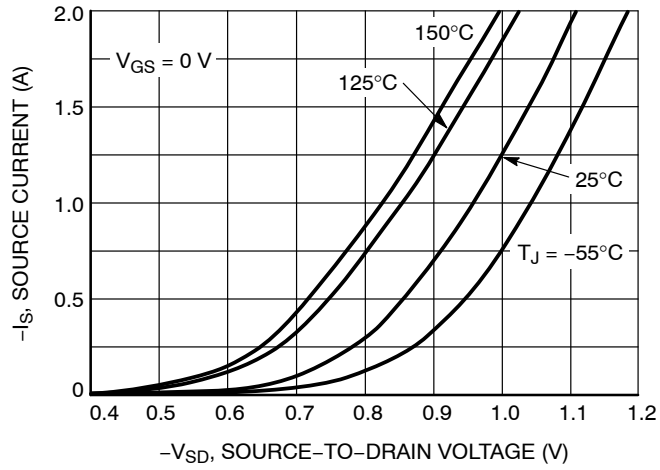
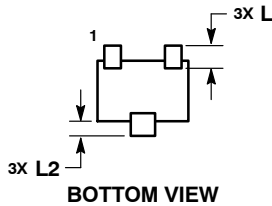
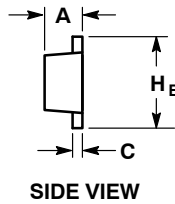
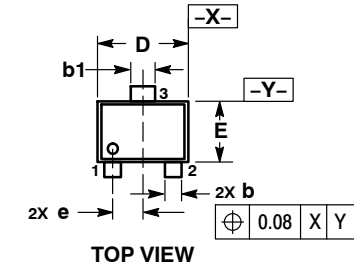

Figure 9. Diode Forward Voltage vs. Current

NTK3139P

PACKAGE DIMENSIONS

SOT-723 CASE 631AA ISSUE D



NOTES:

1. DIMENSIONING AND TOLERANCING PER ASME Y14.5M, 1994.
2. CONTROLLING DIMENSION: MILLIMETERS.
3. MAXIMUM LEAD THICKNESS INCLUDES LEAD FINISH. MINIMUM LEAD THICKNESS IS THE MINIMUM THICKNESS OF BASE MATERIAL.
4. DIMENSIONS D AND E DO NOT INCLUDE MOLD FLASH, PROTRUSIONS OR GATE BURRS.

DIM	MILLIMETERS		
	MIN	NOM	MAX
A	0.45	0.50	0.55
b	0.15	0.21	0.27
b1	0.25	0.31	0.37
C	0.07	0.12	0.17
D	1.15	1.20	1.25
E	0.75	0.80	0.85
e	0.40 BSC		
H E	1.15	1.20	1.25
L	0.29 REF		
L2	0.15	0.20	0.25

STYLE 5:

1. GATE
2. SOURCE
3. DRAIN

RECOMMENDED SOLDERING FOOTPRINT*

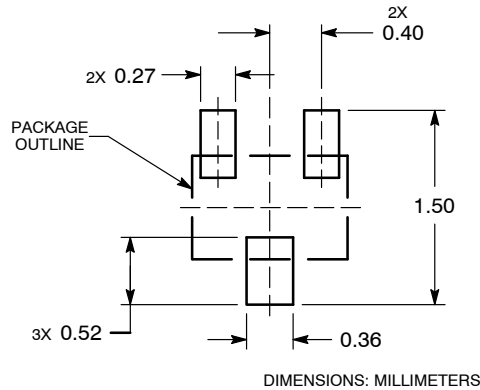

*For additional information on our Pb-Free strategy and soldering details, please download the ON Semiconductor Soldering and Mounting Techniques Reference Manual, SOLDERRM/D.

ON Semiconductor and  are registered trademarks of Semiconductor Components Industries, LLC (SCILLC). SCILLC owns the rights to a number of patents, trademarks, copyrights, trade secrets, and other intellectual property. A listing of SCILLC's product/patent coverage may be accessed at www.onsemi.com/site/pdf/Patent-Marking.pdf. SCILLC reserves the right to make changes without further notice to any products herein. SCILLC makes no warranty, representation or guarantee regarding the suitability of its products for any particular purpose, nor does SCILLC assume any liability arising out of the application or use of any product or circuit, and specifically disclaims any and all liability, including without limitation special, consequential or incidental damages. "Typical" parameters which may be provided in SCILLC data sheets and/or specifications can and do vary in different applications and actual performance may vary over time. All operating parameters, including "Typicals" must be validated for each customer application by customer's technical experts. SCILLC does not convey any license under its patent rights nor the rights of others. SCILLC products are not designed, intended, or authorized for use as components in systems intended for surgical implant into the body, or other applications intended to support or sustain life, or for any other application in which the failure of the SCILLC product could create a situation where personal injury or death may occur. Should Buyer purchase or use SCILLC products for any such unintended or unauthorized application, Buyer shall indemnify and hold SCILLC and its officers, employees, subsidiaries, affiliates, and distributors harmless against all claims, costs, damages, and expenses, and reasonable attorney fees arising out of, directly or indirectly, any claim of personal injury or death associated with such unintended or unauthorized use, even if such claim alleges that SCILLC was negligent regarding the design or manufacture of the part. SCILLC is an Equal Opportunity/Affirmative Action Employer. This literature is subject to all applicable copyright laws and is not for resale in any manner.

PUBLICATION ORDERING INFORMATION

LITERATURE FULFILLMENT:

Literature Distribution Center for ON Semiconductor
P.O. Box 5163, Denver, Colorado 80217 USA
Phone: 303-675-2175 or 800-344-3860 Toll Free USA/Canada
Fax: 303-675-2176 or 800-344-3867 Toll Free USA/Canada
Email: orderlit@onsemi.com

N. American Technical Support: 800-282-9855 Toll Free
USA/Canada
Europe, Middle East and Africa Technical Support:
Phone: 421 33 790 2910
Japan Customer Focus Center
Phone: 81-3-5817-1050

ON Semiconductor Website: www.onsemi.com

Order Literature: <http://www.onsemi.com/orderlit>

For additional information, please contact your local Sales Representative

Mouser Electronics

Authorized Distributor

Click to View Pricing, Inventory, Delivery & Lifecycle Information:

[ON Semiconductor:](#)

[NTK3139PT1G](#)