

# MBD110DWT1G, MBD330DWT1G

## Dual Schottky Barrier Diodes

Application circuit designs are moving toward the consolidation of device count and into smaller packages. The new SOT-363 package is a solution which simplifies circuit design, reduces device count, and reduces board space by putting two discrete devices in one small six-lead package. The SOT-363 is ideal for low-power surface mount applications where board space is at a premium, such as portable products.

### Surface Mount Comparisons:

	SOT-363	SOT-23
Area (mm <sup>2</sup> )	4.6	7.6
Max Package P <sub>D</sub> (mW)	120	225
Device Count	2	1

### Space Savings:

Package	1 x SOT-23	2 x SOT-23
SOT-363	40%	70%

The MBD110DW and MBD330DW devices are spin-offs of our popular MMBD101LT1 and MMBD301LT1 SOT-23 devices. They are designed for high-efficiency UHF and VHF detector applications. Readily available to many other fast switching RF and digital applications.

### Features

- Extremely Low Minority Carrier Lifetime
- Very Low Capacitance
- Low Reverse Leakage
- These Devices are Pb-Free, Halogen Free/BFR Free and are RoHS Compliant

### MAXIMUM RATINGS

Rating	Symbol	Value	Unit
Reverse Voltage MBD110DWT1G MBD330DWT1G	V <sub>R</sub>	7.0 30	V
Forward Current (DC)	I <sub>F</sub>	200 Max	mA
Forward Power Dissipation T <sub>A</sub> = 25°C	P <sub>F</sub>	120	mW
Junction Temperature	T <sub>J</sub>	-55 to +125	°C
Storage Temperature Range	T <sub>stg</sub>	-55 to +150	°C

Stresses exceeding Maximum Ratings may damage the device. Maximum Ratings are stress ratings only. Functional operation above the Recommended Operating Conditions is not implied. Extended exposure to stresses above the Recommended Operating Conditions may affect device reliability.



ON Semiconductor®

<http://onsemi.com>

Anode 1 6 Cathode

N/C 2 5 N/C

Cathode 3 4 Anode



1

SC-88 / SOT-363  
CASE 419B  
STYLE 6

### MARKING DIAGRAM

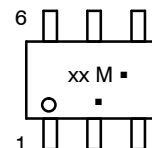

xx = Device Code  
Refer to Ordering Table,  
page 2

M = Date Code  
▪ = Pb-Free Package

(Note: Microdot may be in either location)

### ORDERING INFORMATION

See detailed ordering and shipping information in the package dimensions section on page 2 of this data sheet.

## MBD110DWT1G, MBD330DWT1G

### ELECTRICAL CHARACTERISTICS (T<sub>A</sub> = 25°C unless otherwise noted)

Characteristic		Symbol	Min	Typ	Max	Unit
Reverse Breakdown Voltage (I <sub>R</sub> = 10 μA)	MBD110DWT1G MBD330DWT1G	V <sub>(BR)R</sub>	7.0 30	10 -	- -	V
Diode Capacitance (V <sub>R</sub> = 0, f = 1.0 MHz, Note 1)	MBD110DWT1G	C <sub>D</sub>	-	0.88	1.0	pF
Total Capacitance (V <sub>R</sub> = 15 Volts, f = 1.0 MHz)	MBD330DWT1G	C <sub>T</sub>	-	0.9	1.5	pF
Reverse Leakage (V <sub>R</sub> = 3.0 V) (V <sub>R</sub> = 25 V)	MBD110DWT1G MBD330DWT1G	I <sub>R</sub>	- -	0.02 13	0.25 200	μA nA
Noise Figure (f = 1.0 GHz, Note 2)	MBD110DWT1G	NF	-	6.0	-	dB
Forward Voltage (I <sub>F</sub> = 10 mA) (I <sub>F</sub> = 1.0 mA) (I <sub>F</sub> = 10 mA)	MBD110DWT1G MBD330DWT1G	V <sub>F</sub>	- - -	0.5 0.38 0.52	0.6 0.45 0.6	V

### ORDERING INFORMATION

Device	Marking	Package	Shipping†
MBD110DWT1G	M4	SC-88 / SOT-363 (Pb-Free)	3000 Units / Tape & Reel
MBD330DWT1G	T4		

†For information on tape and reel specifications, including part orientation and tape sizes, please refer to our Tape and Reel Packaging Specifications Brochure, BRD8011/D.

# MBD110DWT1G, MBD330DWT1G

## TYPICAL CHARACTERISTICS MBD110DWT1G

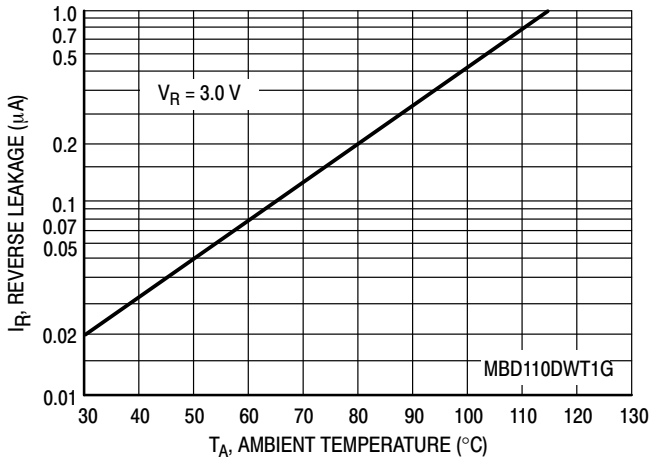

Figure 1. Reverse Leakage

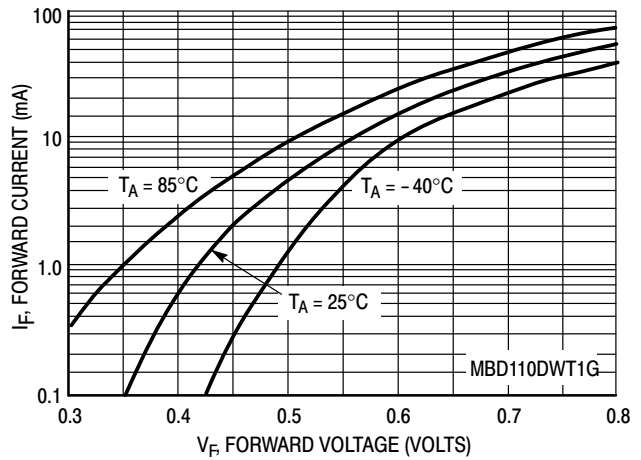

Figure 2. Forward Voltage

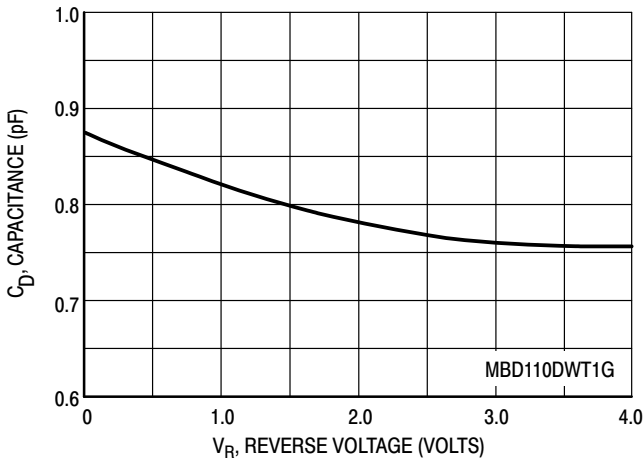

Figure 3. Capacitance

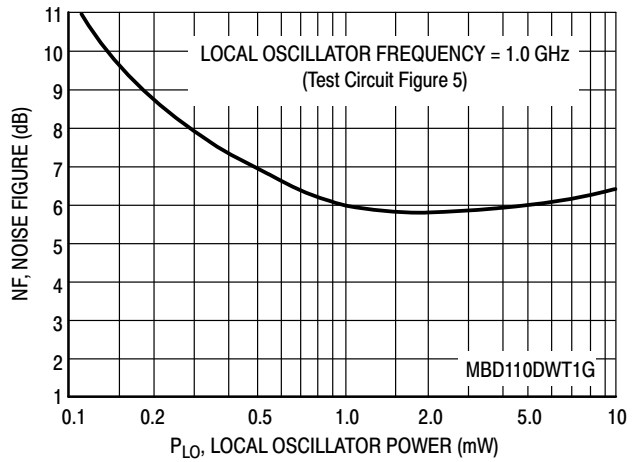

Figure 4. Noise Figure

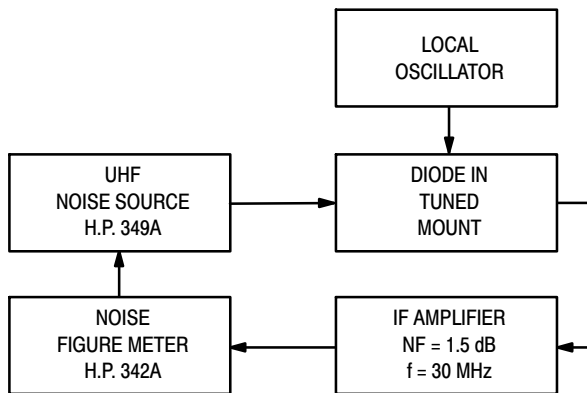

Figure 5. Noise Figure Test Circuit

### NOTES ON TESTING AND SPECIFICATIONS

- Note 1 – C<sub>D</sub> and C<sub>T</sub> are measured using a capacitance bridge (Boonton Electronics Model 75A or equivalent).
- Note 2 – Noise figure measured with diode under test in tuned diode mount using UHF noise source and local oscillator (LO) frequency of 1.0 GHz. The LO power is adjusted for 1.0 mW. IF amplifier NF = 1.5 dB, f = 30 MHz, see Figure 5.
- Note 3 – L<sub>S</sub> is measured on a package having a short instead of a die, using an impedance bridge (Boonton Radio Model 250A RX Meter).

# MBD110DWT1G, MBD330DWT1G

## TYPICAL CHARACTERISTICS MBD330DWT1G

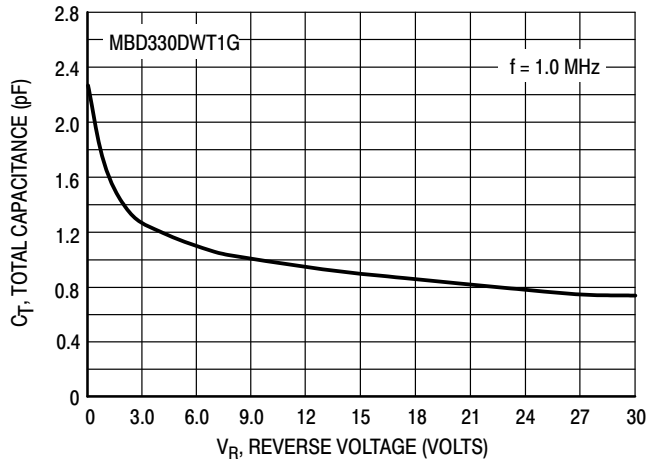

Figure 6. Total Capacitance

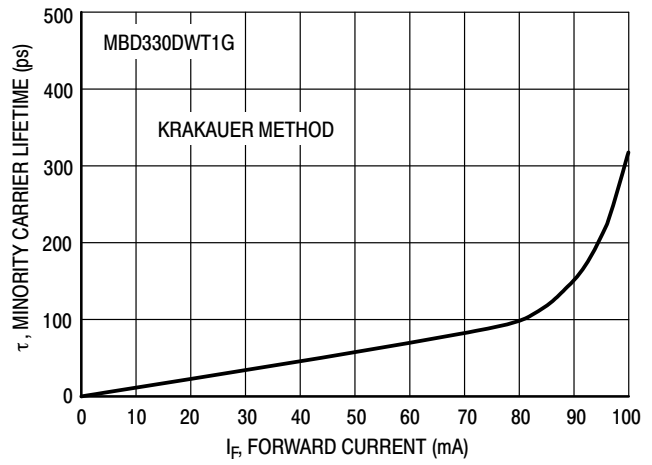

Figure 7. Minority Carrier Lifetime

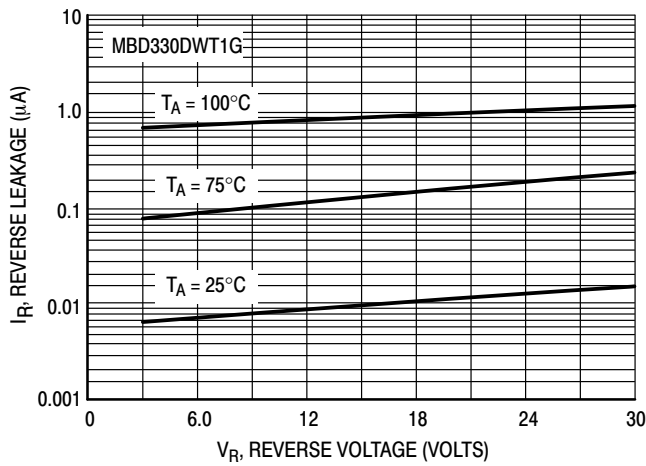

Figure 8. Reverse Leakage

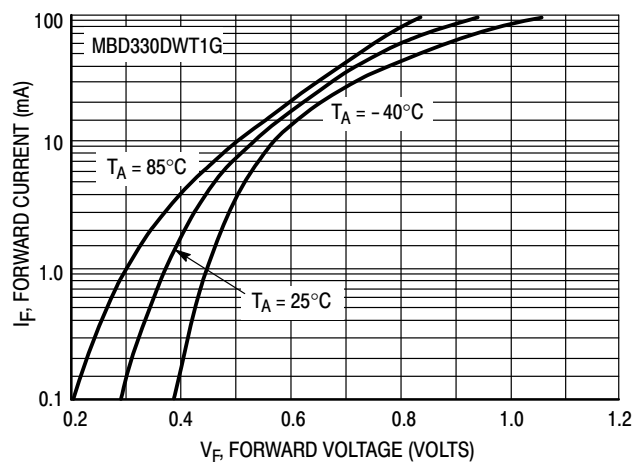
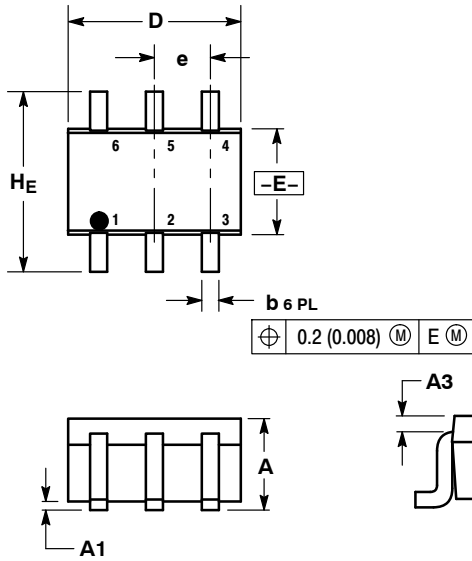

Figure 9. Forward Voltage

# MBD110DWT1G, MBD330DWT1G

## PACKAGE DIMENSIONS

SC-88 / SC-70 / SOT-363  
CASE 419B-02  
ISSUE W



NOTES:

1. DIMENSIONING AND TOLERANCING PER ANSI Y14.5M, 1982.
2. CONTROLLING DIMENSION: INCH.
3. 419B-01 OBSOLETE, NEW STANDARD 419B-02.

DIM	MILLIMETERS			INCHES		
	MIN	NOM	MAX	MIN	NOM	MAX
A	0.80	0.95	1.10	0.031	0.037	0.043
A1	0.00	0.05	0.10	0.000	0.002	0.004
A3	0.20 REF			0.008 REF		
b	0.10	0.21	0.30	0.004	0.008	0.012
C	0.10	0.14	0.25	0.004	0.005	0.010
D	1.80	2.00	2.20	0.070	0.078	0.086
E	1.15	1.25	1.35	0.045	0.049	0.053
e	0.65 BSC			0.026 BSC		
L	0.10	0.20	0.30	0.004	0.008	0.012
HE	2.00	2.10	2.20	0.078	0.082	0.086

STYLE 6:

- PIN 1. ANODE 2
- 2. N/C
- 3. CATHODE 1
- 4. ANODE 1
- 5. N/C
- 6. CATHODE 2

### SOLDERING FOOTPRINT\*

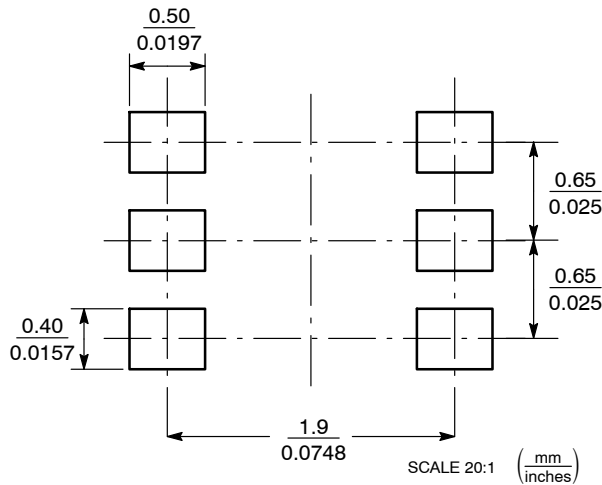

\*For additional information on our Pb-Free strategy and soldering details, please download the ON Semiconductor Soldering and Mounting Techniques Reference Manual, SOLDERRM/D.

ON Semiconductor and are registered trademarks of Semiconductor Components Industries, LLC (SCILLC). SCILLC owns the rights to a number of patents, trademarks, copyrights, trade secrets, and other intellectual property. A listing of SCILLC's product/patent coverage may be accessed at [www.onsemi.com/site/pdf/Patent-Marking.pdf](http://www.onsemi.com/site/pdf/Patent-Marking.pdf). SCILLC reserves the right to make changes without further notice to any products herein. SCILLC makes no warranty, representation or guarantee regarding the suitability of its products for any particular purpose, nor does SCILLC assume any liability arising out of the application or use of any product or circuit, and specifically disclaims any and all liability, including without limitation special, consequential or incidental damages. "Typical" parameters which may be provided in SCILLC data sheets and/or specifications can and do vary in different applications and actual performance may vary over time. All operating parameters, including "Typicals" must be validated for each customer application by customer's technical experts. SCILLC does not convey any license under its patent rights nor the rights of others. SCILLC products are not designed, intended, or authorized for use as components in systems intended for surgical implant into the body, or other applications intended to support or sustain life, or for any other application in which the failure of the SCILLC product could create a situation where personal injury or death may occur. Should Buyer purchase or use SCILLC products for any such unintended or unauthorized application, Buyer shall indemnify and hold SCILLC and its officers, employees, subsidiaries, affiliates, and distributors harmless against all claims, costs, damages, and expenses, and reasonable attorney fees arising out of, directly or indirectly, any claim of personal injury or death associated with such unintended or unauthorized use, even if such claim alleges that SCILLC was negligent regarding the design or manufacture of the part. SCILLC is an Equal Opportunity/Affirmative Action Employer. This literature is subject to all applicable copyright laws and is not for resale in any manner.

### PUBLICATION ORDERING INFORMATION

LITERATURE FULFILLMENT:

Literature Distribution Center for ON Semiconductor  
P.O. Box 5163, Denver, Colorado 80217 USA  
Phone: 303-675-2175 or 800-344-3860 Toll Free USA/Canada  
Fax: 303-675-2176 or 800-344-3867 Toll Free USA/Canada  
Email: [orderlit@onsemi.com](mailto:orderlit@onsemi.com)

N. American Technical Support: 800-282-9855 Toll Free  
USA/Canada  
Europe, Middle East and Africa Technical Support:  
Phone: 421 33 790 2910  
Japan Customer Focus Center  
Phone: 81-3-5817-1050

ON Semiconductor Website: [www.onsemi.com](http://www.onsemi.com)

Order Literature: <http://www.onsemi.com/orderlit>

For additional information, please contact your local Sales Representative

# Mouser Electronics

Authorized Distributor

Click to View Pricing, Inventory, Delivery & Lifecycle Information:

[ON Semiconductor:](#)

[MBD330DWT1G](#) [MBD770DWT1G](#)