



2SK4198FS

N-Channel Power MOSFET 600V, 5A, 2.34Ω, TO-220F-3FS

ON Semiconductor®
<http://onsemi.com>

Features

- ON-resistance $R_{DS(on)}=1.8\Omega$ (typ.)
- 10V drive
- Input capacitance $C_{iss}=360pF$ (typ.)
- Repetitive avalanche guarantee

Specifications

Absolute Maximum Ratings at $T_a=25^\circ C$

Parameter	Symbol	Conditions	Ratings	Unit
Drain-to-Source Voltage	V_{DSS}		600	V
Gate-to-Source Voltage	V_{GSS}		± 30	V
Drain Current (DC)	I_{DC}^*1	Limited only by maximum temperature $T_{ch}=150^\circ C$	5	A
	I_{Dpack}^*2	$T_c=25^\circ C$ (Our ideal heat dissipation condition)*3	4	A
Drain Current (Pulse)	I_{DP}	$PW \leq 10\mu s$, duty cycle $\leq 1\%$	18	A
Allowable Power Dissipation	P_D		2.0	W
		$T_c=25^\circ C$ (Our ideal heat dissipation condition)*3	30	W
Channel Temperature	T_{ch}		150	$^\circ C$
Storage Temperature	T_{stg}		-55 to +150	$^\circ C$
Avalanche Energy (Single Pulse) *4	E_{AS}		55	mJ
Avalanche Current *5	I_{AV}		4.5	A
Avalanche Energy (Repetition)	E_{AR}	Limited only by maximum temperature $T_{ch}=150^\circ C$	3	mJ

Note : *1 Shows chip capability.

*2 Package limited.

*3 Our condition is radiation from backside.

The method is applying silicone grease to the backside of the device and attaching the device to water-cooled radiator made of aluminium.

*4 $V_{DD}=50V$, $L=5mH$, $I_{AV}=4.5A$ (Fig.1)

*5 $L \leq 5mH$, Single pulse

Stresses exceeding Maximum Ratings may damage the device. Maximum Ratings are stress ratings only. Functional operation above the Recommended Operating Conditions is not implied. Extended exposure to stresses above the Recommended Operating Conditions may affect device reliability.

Package Dimensions

unit : mm (typ)

7528-001

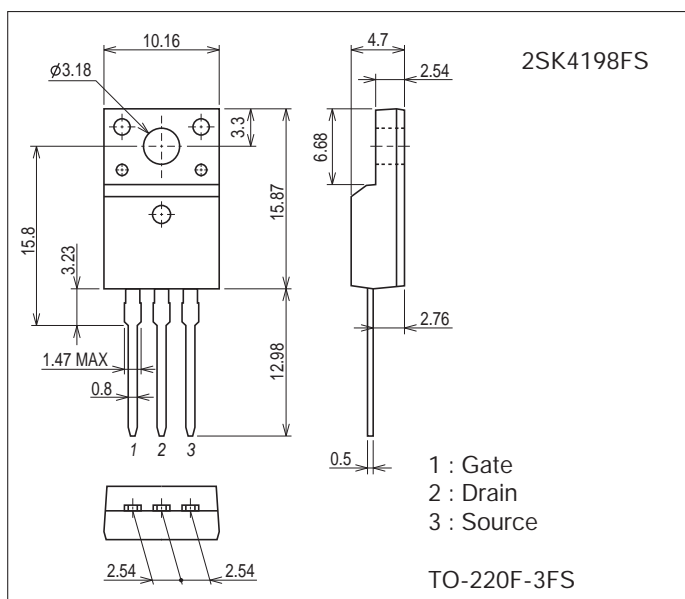

Product & Package Information

- Package : TO-220F-3FS
- JEITA, JEDEC : SC-67
- Minimum Packing Quantity : 50 pcs./magazine

Marking

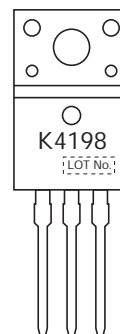

Electrical Connection

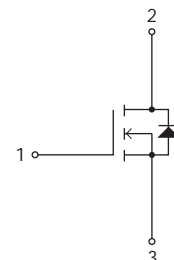

2SK4198FS

Electrical Characteristics at Ta=25°C

Parameter	Symbol	Conditions	Ratings			Unit	
			min	typ	max		
Drain-to-Source Breakdown Voltage	V(BR)DSS	ID=10mA, VGS=0V	600			V	
Zero-Gate Voltage Drain Current	IDSS	VDS=480V, VGS=0V			100	μA	
Gate-to-Source Leakage Current	IGSS	VGS=±30V, VDS=0V			±100	nA	
Cutoff Voltage	VGS(off)	VDS=10V, ID=1mA	3		5	V	
Forward Transfer Admittance	yfs	VDS=10V, ID=2.5A	1.2	2.4		S	
Static Drain-to-Source On-State Resistance	RDS(on)	ID=2.5A, VGS=10V		1.8	2.34	Ω	
Input Capacitance	Ciss	VDS=30V, f=1MHz		360		pF	
Output Capacitance	Coss				69		pF
Reverse Transfer Capacitance	Crss				15		pF
Turn-ON Delay Time	td(on)	See Fig.2		13		ns	
Rise Time	tr			28		ns	
Turn-OFF Delay Time	td(off)			39		ns	
Fall Time	tf			15		ns	
Total Gate Charge	Qg	VDS=200V, VGS=10V, ID=5A		14.3		nC	
Gate-to-Source Charge	Qgs			3.0		nC	
Gate-to-Drain "Miller" Charge	Qgd			8.2		nC	
Diode Forward Voltage	VSD	IS=5A, VGS=0V		0.9	1.2	V	

Fig.1 Unclamped Inductive Switching Test Circuit

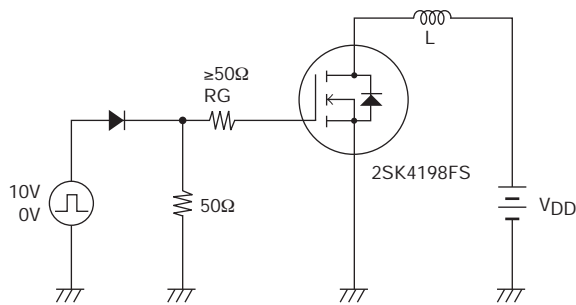
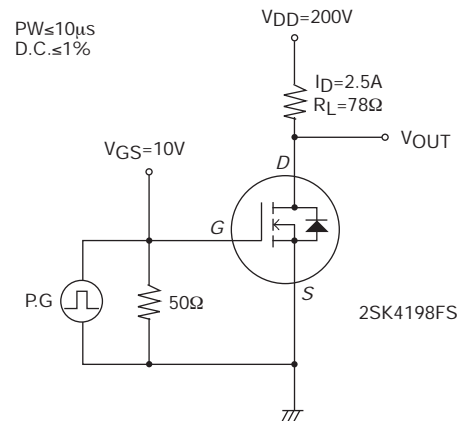

Fig.2 Switching Time Test Circuit



Ordering Information

Device	Package	Shipping	memo
2SK4198FS	TO-220F-3FS	50pcs./magazine	Pb Free

2SK4198FS

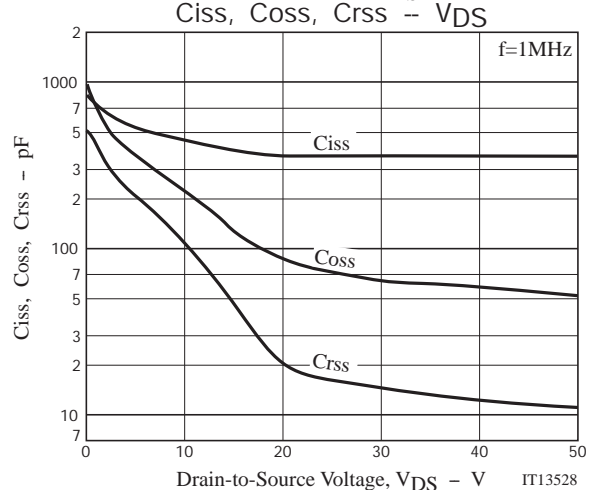
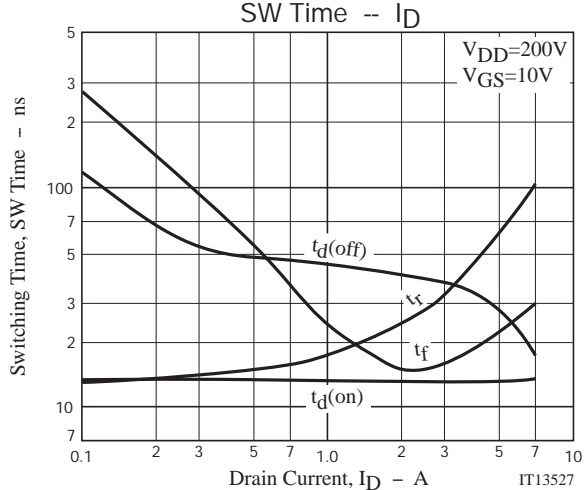
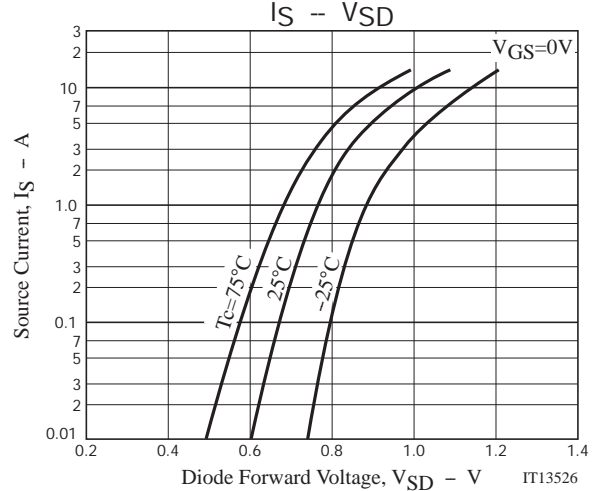
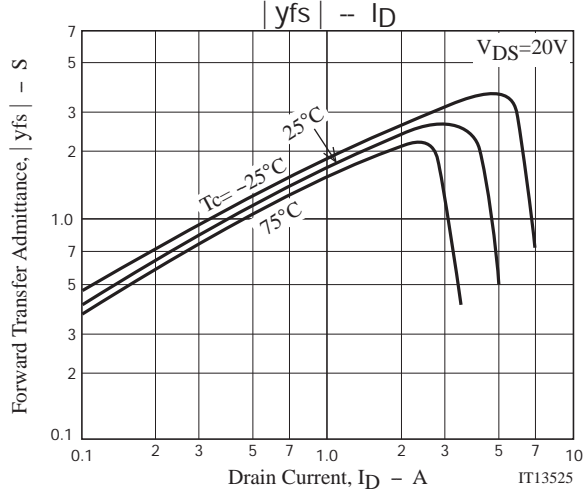
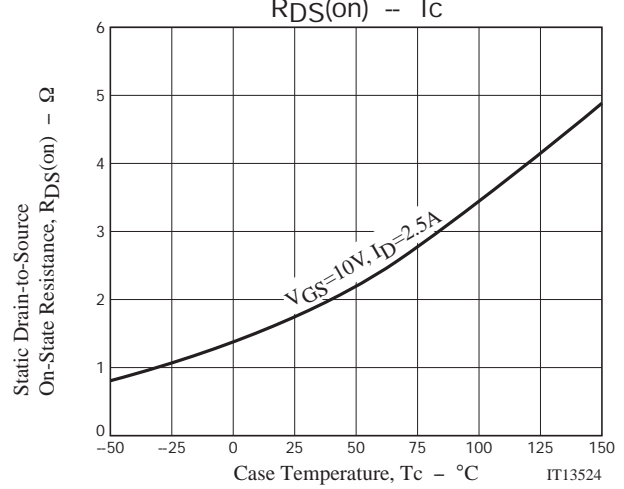
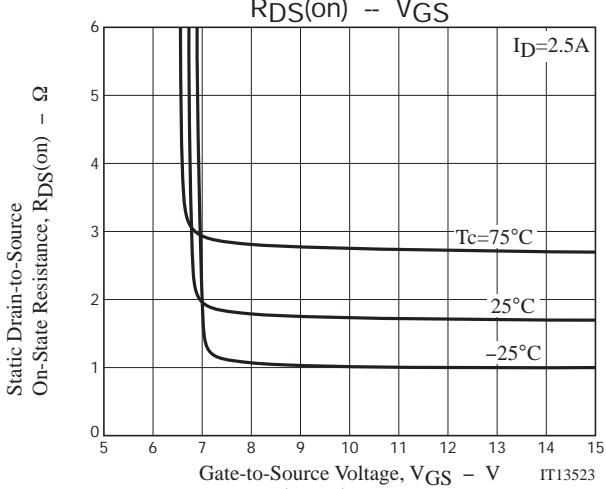
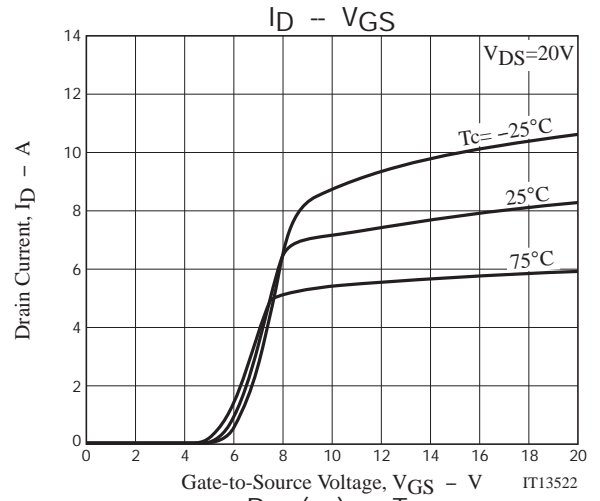
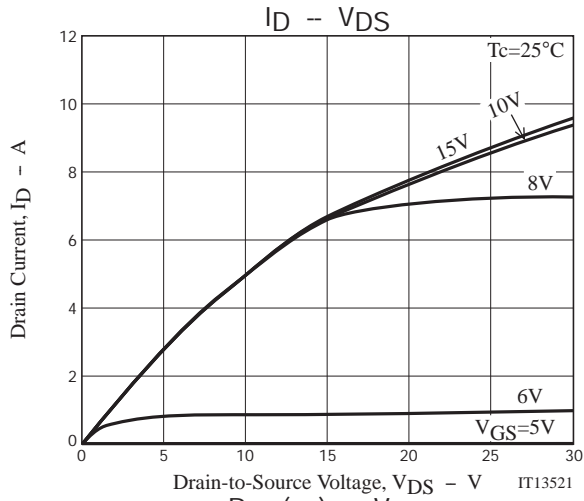

2SK4198FS

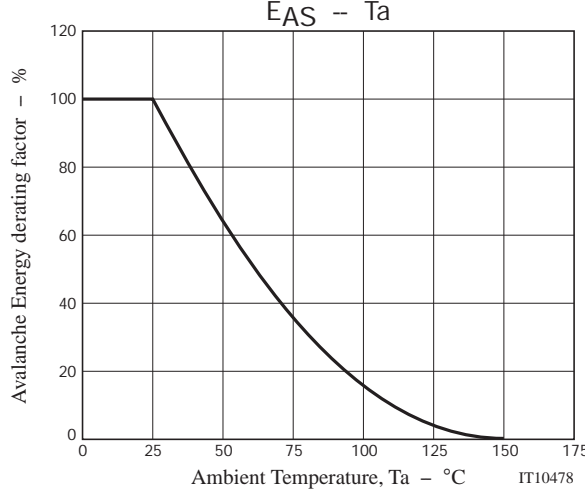
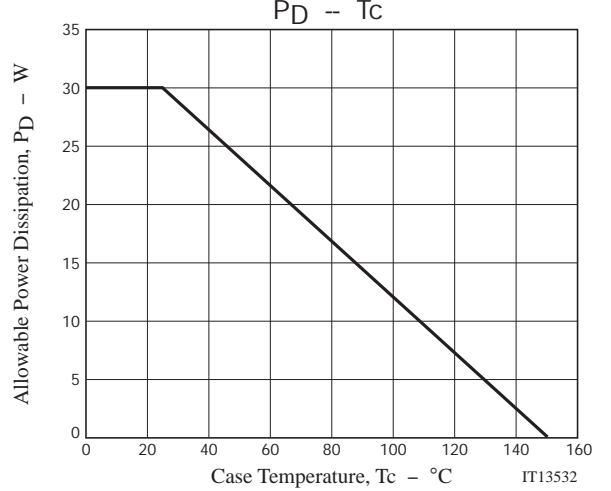
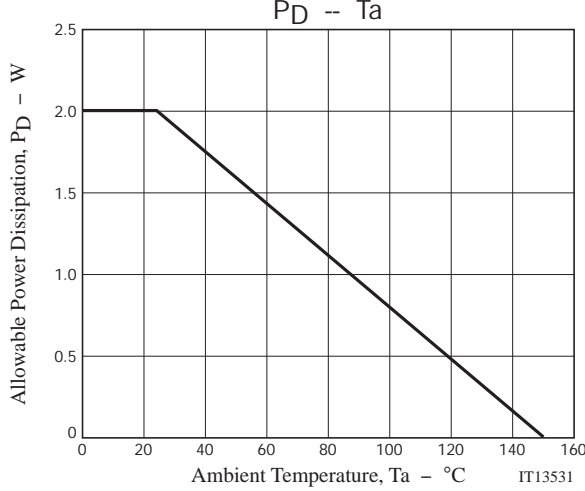
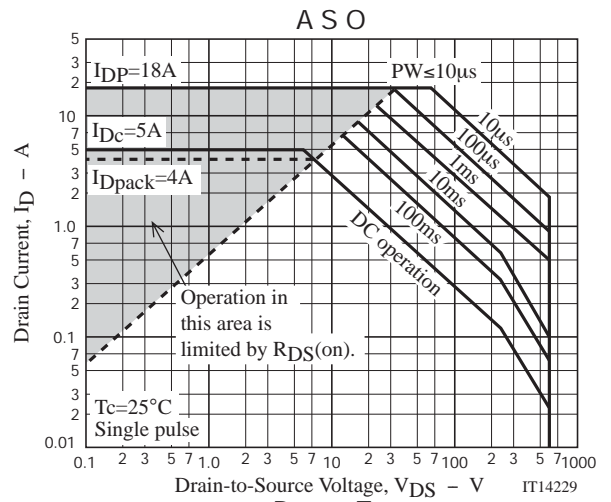
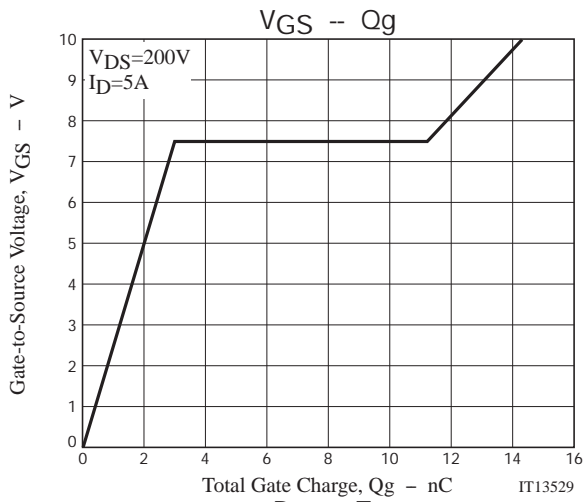

2SK4198FS

Magazine Specification

2SK4198FS

1. Packing Format

Package Name	Magazine Name	Maximum Number of devices contained (pcs)			Packing format	
		Magazine	Inner box	Outer box	Inner BOX	Outer BOX
TO-220F-3FS	TO-220F	50	1,000	4,000	SPD-0V0001 20 magazines contained Dimensions:mm (external) 568×150×55	SPT-081029 4 inner boxes contained Dimensions:mm (external) 590×225×178

2. Magazine dimensions

(unit:mm)

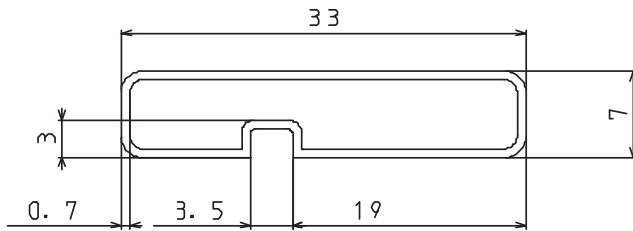

Tolerance=±0.3mm
 Thickness=0.7±0.2mm
 Length =532.5±2mm
 Material =PVC (Antistatic treatment)

3. Storage method to magazine

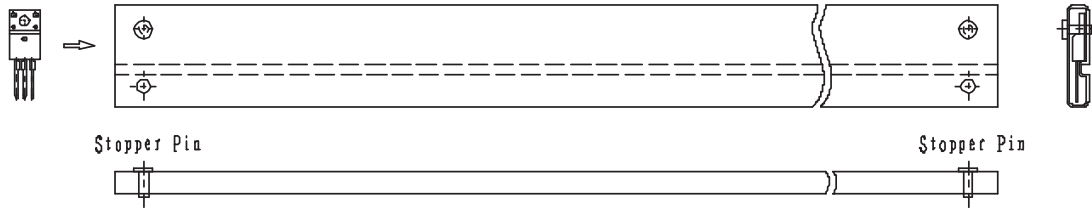

4. Inner box label (unit:mm)

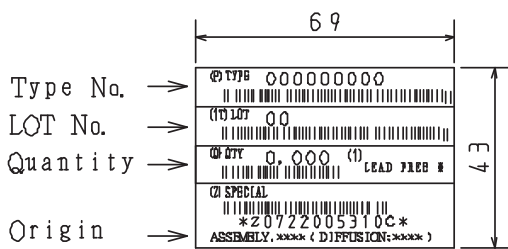

5. Outer box label (unit:mm)

It is a label at the time of factory shipments.
 The form of a label may change in physical
 distribution process.

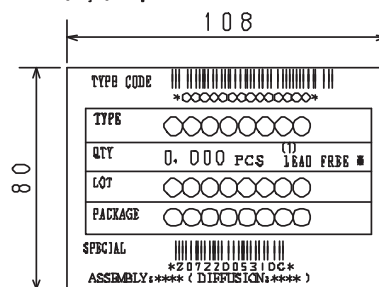

NOTE (1)

The LEAD FREE # description shows that the surface treatment of the terminal is lead free.

Label	JEITA Phase
LEAD FREE 3	JEITA Phase 3A

2SK4198FS

Outline Drawing
2SK4198FS

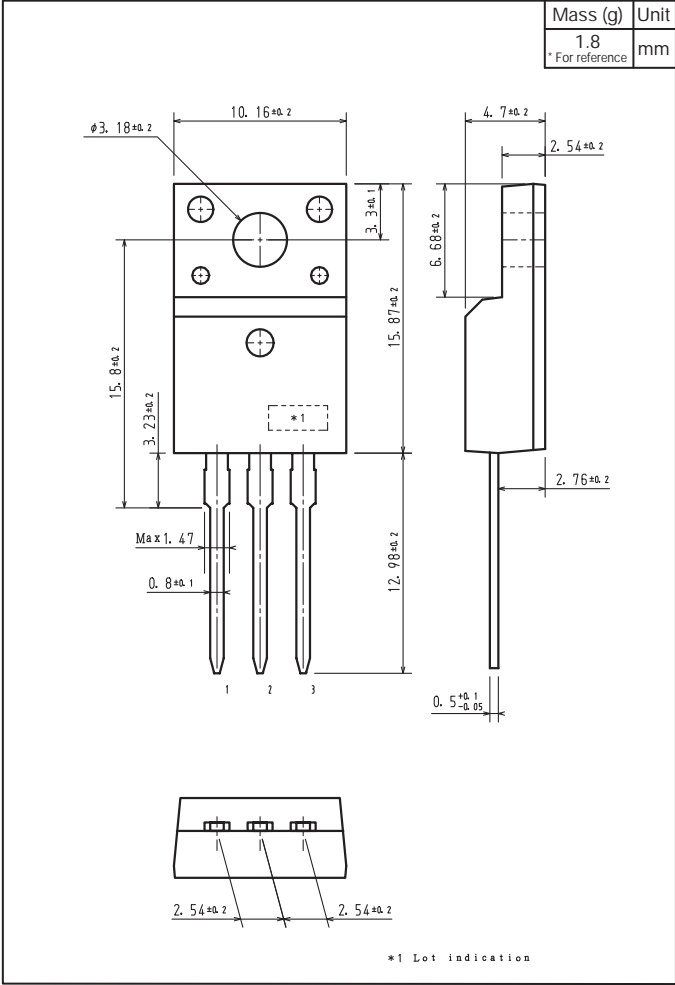

Note on usage : Since the 2SK4198FS is a MOSFET product, please avoid using this device in the vicinity of highly charged objects.

ON Semiconductor and the ON logo are registered trademarks of Semiconductor Components Industries, LLC (SCILLC). SCILLC owns the rights to a number of patents, trademarks, copyrights, trade secrets, and other intellectual property. A listing of SCILLC's product/patent coverage may be accessed at www.onsemi.com/site/pdf/Patent-Marking.pdf. SCILLC reserves the right to make changes without further notice to any products herein. SCILLC makes no warranty, representation or guarantee regarding the suitability of its products for any particular purpose, nor does SCILLC assume any liability arising out of the application or use of any product or circuit, and specifically disclaims any and all liability, including without limitation special, consequential or incidental damages. "Typical" parameters which may be provided in SCILLC data sheets and/or specifications can and do vary in different applications and actual performance may vary over time. All operating parameters, including "Typicals" must be validated for each customer application by customer's technical experts. SCILLC does not convey any license under its patent rights nor the rights of others. SCILLC products are not designed, intended, or authorized for use as components in systems intended for surgical implant into the body, or other applications intended to support or sustain life, or for any other application in which the failure of the SCILLC product could create a situation where personal injury or death may occur. Should Buyer purchase or use SCILLC products for any such unintended or unauthorized application, Buyer shall indemnify and hold SCILLC and its officers, employees, subsidiaries, affiliates, and distributors harmless against all claims, costs, damages, and expenses, and reasonable attorney fees arising out of, directly or indirectly, any claim of personal injury or death associated with such unintended or unauthorized use, even if such claim alleges that SCILLC was negligent regarding the design or manufacture of the part. SCILLC is an Equal Opportunity/Affirmative Action Employer. This literature is subject to all applicable copyright laws and is not for resale in any manner.

Mouser Electronics

Authorized Distributor

Click to View Pricing, Inventory, Delivery & Lifecycle Information:

[ON Semiconductor:](#)

[2SK4198FS](#)