

1SMF5920B

2.5 Watt Zener Diode in Flat Lead Package

This complete new line of 2.5 Watt Zener Diodes are offered in highly efficient micro miniature and space saving surface mount design. Because of its small size, it is ideal for use in cellular phones, portable devices, business machines and many other industrial/consumer applications.

Features

- Zener Breakdown Voltage: 6.2 V
- Low Leakage < 5 μ A
- ESD Rating of Class 3 (> 16 kV) per Human Body Model
- Small Footprint – Footprint Area of 8.45 mm²
- Low Profile – Maximum Height of 1.0 mm
- Supplied in 8 mm Tape and Reel – 3,000 Units per Reel
- Cathode Indicated by Polarity Band
- Lead Orientation in Tape: Cathode Lead to Sprocket Holes
- These Devices are Pb-Free, Halogen Free/BFR Free and are RoHS Compliant

Mechanical Characteristics:

CASE: Void-free, transfer-molded, thermosetting plastic
Epoxy Meets UL 94 V-0

LEAD FINISH: 100% Matte Sn (Tin)

MOUNTING POSITION: Any

QUALIFIED MAX REFLOW TEMPERATURE: 260°C

Device Meets MSL 1 Requirements



ON Semiconductor®

<http://onsemi.com>

PLASTIC SURFACE MOUNT 2.5 WATT ZENER DIODE 6.2 VOLTS

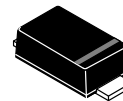
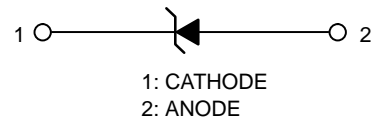

**SOD-123FL
CASE 498**

MARKING DIAGRAM

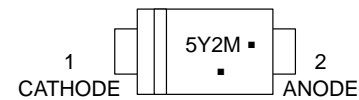

5Y2 = Device Code

M = Date Code

▪ = Pb-Free Package

(Note: Microdot may be in either location)

ORDERING INFORMATION

| Device | Package | Shipping [†] |
|--------------|------------------------|-----------------------|
| 1SMF5920BT1G | SOD-123FL (Pb-Free) | 3000/Tape & Reel |

[†]For information on tape and reel specifications, including part orientation and tape sizes, please refer to our Tape and Reel Packaging Specifications Brochure, BRD8011/D.

1SMF5920B

MAXIMUM RATINGS

| Rating | Symbol | Value | Unit |
|---|-----------------|-------------|----------------------------|
| DC Power Dissipation @ $T_A = 25^\circ\text{C}$ (Note 1) Derate above 25°C | P_D | 350 | mW |
| Thermal Resistance, Junction-to-Ambient | $R_{\theta JA}$ | 2.9 | $\text{mW}/^\circ\text{C}$ |
| Thermal Resistance, Junction-to-Lead | $R_{\theta JL}$ | 350 | $^\circ\text{C}/\text{W}$ |
| Maximum DC Power Dissipation (Notes 1 and 2) | P_D | 30 | $^\circ\text{C}/\text{W}$ |
| Operating and Storage Temperature Range | T_J, T_{stg} | -55 to +150 | $^\circ\text{C}$ |

Stresses exceeding those listed in the Maximum Ratings table may damage the device. If any of these limits are exceeded, device functionality should not be assumed, damage may occur and reliability may be affected.

1. Mounted with recommended minimum pad size, PC board FR-4.
2. At lead temperature 75°C

ELECTRICAL CHARACTERISTICS ($T_A = 25^\circ\text{C}$ unless otherwise noted, $V_F = 1.5\text{ V Max.}$ @ $I_F = 200\text{ mA}$ for all types)

| Symbol | Parameter |
|-----------|---|
| I_{PP} | Maximum Reverse Peak Pulse Current |
| V_C | Clamping Voltage @ I_{PP} |
| V_{RWM} | Working Peak Reverse Voltage |
| I_R | Maximum Reverse Leakage Current @ V_{RWM} |
| V_{BR} | Breakdown Voltage @ I_T |
| I_T | Test Current |
| I_F | Forward Current |
| V_F | Forward Voltage @ I_F |

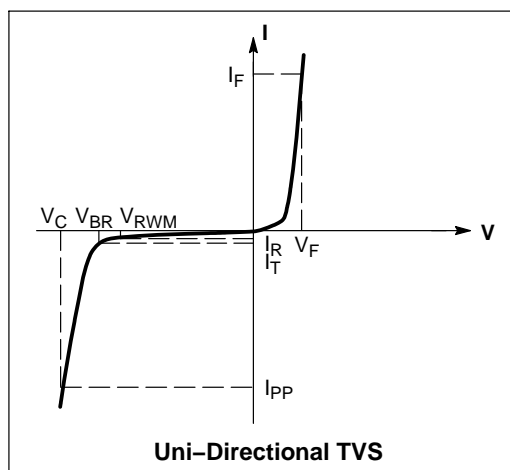

ELECTRICAL CHARACTERISTICS ($T_L = 30^\circ\text{C}$ unless otherwise noted, $V_F = 1.25\text{ Volts}$ @ 200 mA)

| Device | Device Marking | Zener Voltage (Note 3) | | | I_{ZT} (mA) | I_R @ V_R (μA) | V_R (V) | Z_{ZT} @ I_{ZT} (Note 4) (Ω) | Z_{ZK} @ I_{ZK} (Note 4) (Ω) | I_{ZK} (mA) |
|--------------|----------------|--------------------------|-----|------|------------------|------------------------------------|--------------|---|---|------------------|
| | | V_Z @ I_{ZT} (Volts) | | | | | | | | |
| | | Min | Nom | Max | | | | | | |
| 1SMF5920BT1G | 5Y2 | 5.89 | 6.2 | 6.51 | 60.5 | 5.0 | 4.0 | 2.0 | 200 | 1.0 |

Product parametric performance is indicated in the Electrical Characteristics for the listed test conditions, unless otherwise noted. Product performance may not be indicated by the Electrical Characteristics if operated under different conditions.

3. Zener voltage is measured with the device junction in thermal equilibrium with an ambient temperature of 25°C .
4. Zener Impedance Derivation Z_{ZT} and Z_{ZK} are measured by dividing the AC voltage drop across the device by the AC current applied. The specified limits are for $I_{Z(ac)} = 0.1 I_{Z(dc)}$ with the ac frequency = 60 Hz.

1SMF5920B

TYPICAL CHARACTERISTICS

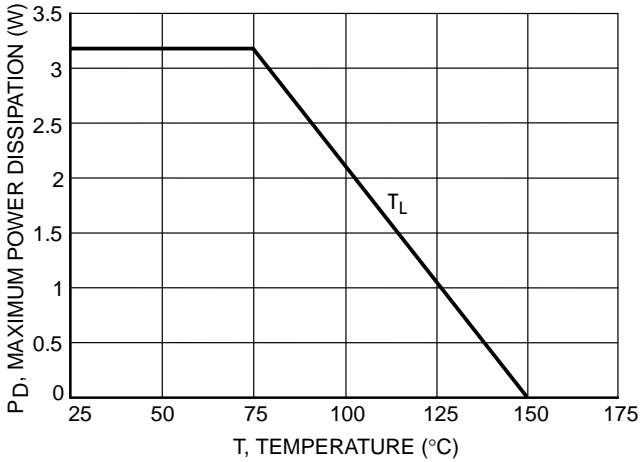

Figure 1. Steady State Power Derating

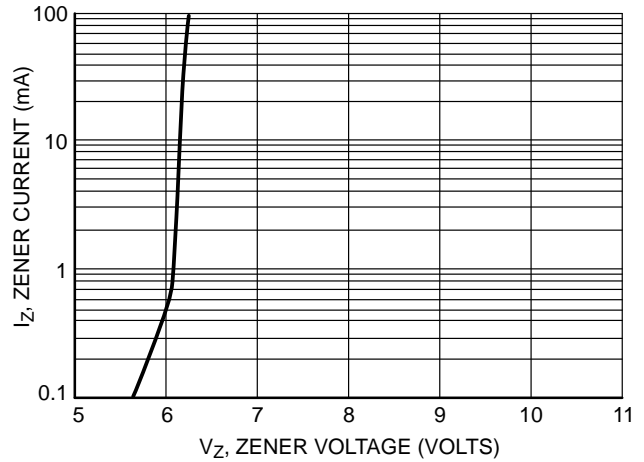

Figure 2. V_Z

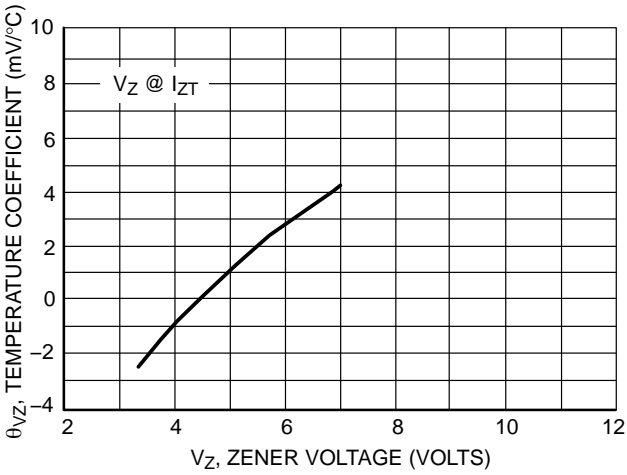

Figure 3. Zener Voltage

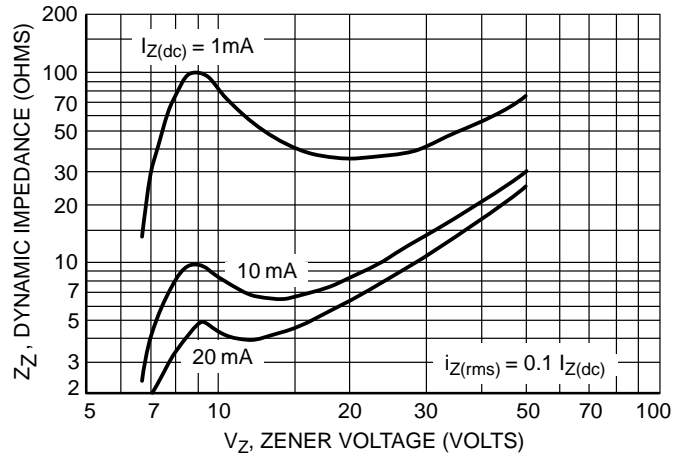

Figure 4. Effect of Zener Voltage

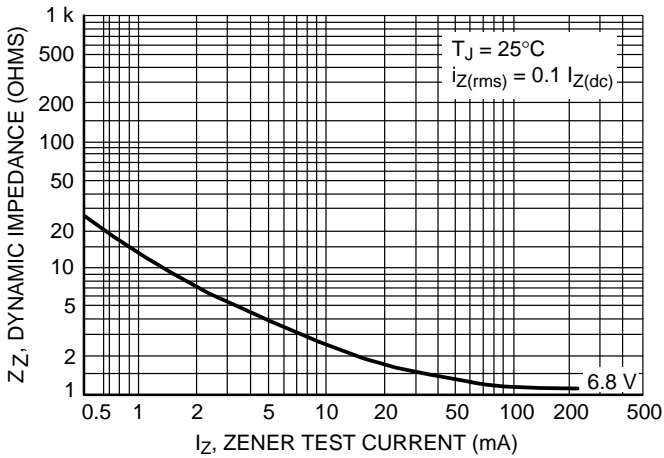

Figure 5. Effect of Zener Current

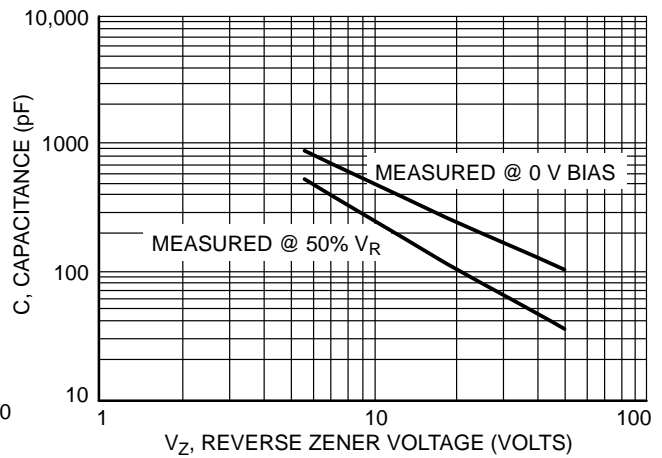
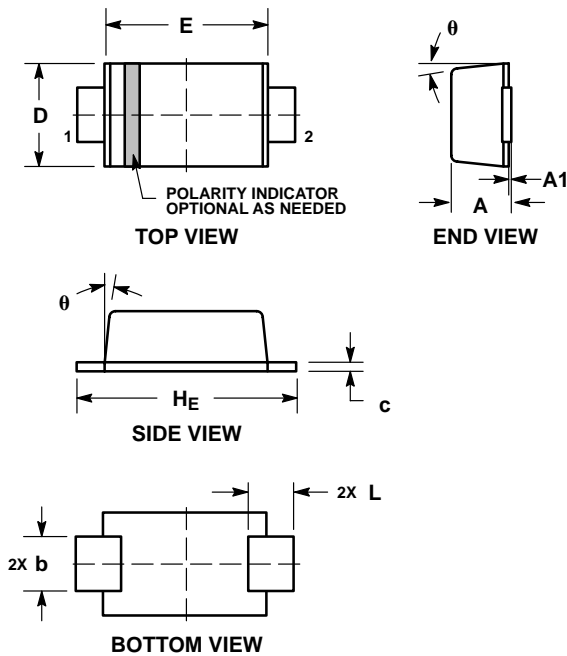

Figure 6. Capacitance versus Reverse Zener Voltage

1SMF5920B

PACKAGE DIMENSIONS

SOD-123FL
CASE 498
ISSUE D



NOTES:

1. DIMENSIONING AND TOLERANCING PER ANSI Y14.5M, 1982.
2. CONTROLLING DIMENSION: MILLIMETER.
3. DIMENSIONS A AND B DO NOT INCLUDE MOLD FLASH.
4. DIMENSIONS D AND J ARE TO BE MEASURED ON FLAT SECTION OF THE LEAD: BETWEEN 0.10 AND 0.25 MM FROM THE LEAD TIP.

| DIM | MILLIMETERS | | | INCHES | | |
|-----|-------------|------|------|--------|-------|-------|
| | MIN | NOM | MAX | MIN | NOM | MAX |
| A | 0.90 | 0.95 | 0.98 | 0.035 | 0.037 | 0.039 |
| A1 | 0.00 | 0.05 | 0.10 | 0.000 | 0.002 | 0.004 |
| b | 0.70 | 0.90 | 1.10 | 0.028 | 0.035 | 0.043 |
| c | 0.10 | 0.15 | 0.20 | 0.004 | 0.006 | 0.008 |
| D | 1.50 | 1.65 | 1.80 | 0.059 | 0.065 | 0.071 |
| E | 2.50 | 2.70 | 2.90 | 0.098 | 0.106 | 0.114 |
| L | 0.55 | 0.75 | 0.95 | 0.022 | 0.030 | 0.037 |
| HE | 3.40 | 3.60 | 3.80 | 0.134 | 0.142 | 0.150 |
| θ | 0° | - | 8° | 0° | - | 8° |

RECOMMENDED SOLDERING FOOTPRINT*

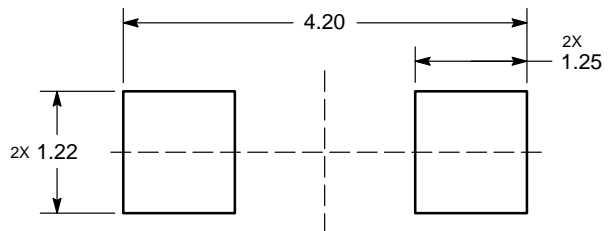

DIMENSIONS: MILLIMETERS

*For additional information on our Pb-Free strategy and soldering details, please download the ON Semiconductor Soldering and Mounting Techniques Reference Manual, SOLDERRM/D.

ON Semiconductor and the are registered trademarks of Semiconductor Components Industries, LLC (SCILLC) or its subsidiaries in the United States and/or other countries. SCILLC owns the rights to a number of patents, trademarks, copyrights, trade secrets, and other intellectual property. A listing of SCILLC's product/patent coverage may be accessed at www.onsemi.com/site/pdf/Patent-Marking.pdf. SCILLC reserves the right to make changes without further notice to any products herein. SCILLC makes no warranty, representation or guarantee regarding the suitability of its products for any particular purpose, nor does SCILLC assume any liability arising out of the application or use of any product or circuit, and specifically disclaims any and all liability, including without limitation special, consequential or incidental damages. "Typical" parameters which may be provided in SCILLC data sheets and/or specifications can and do vary in different applications and actual performance may vary over time. All operating parameters, including "Typicals" must be validated for each customer application by customer's technical experts. SCILLC does not convey any license under its patent rights nor the rights of others. SCILLC products are not designed, intended, or authorized for use as components in systems intended for surgical implant into the body, or other applications intended to support or sustain life, or for any other application in which the failure of the SCILLC product could create a situation where personal injury or death may occur. Should Buyer purchase or use SCILLC products for any such unintended or unauthorized application, Buyer shall indemnify and hold SCILLC and its officers, employees, subsidiaries, affiliates, and distributors harmless against all claims, costs, damages, and expenses, and reasonable attorney fees arising out of, directly or indirectly, any claim of personal injury or death associated with such unintended or unauthorized use, even if such claim alleges that SCILLC was negligent regarding the design or manufacture of the part. SCILLC is an Equal Opportunity/Affirmative Action Employer. This literature is subject to all applicable copyright laws and is not for resale in any manner.

PUBLICATION ORDERING INFORMATION

LITERATURE FULFILLMENT:
Literature Distribution Center for ON Semiconductor
P.O. Box 5163, Denver, Colorado 80217 USA
Phone: 303-675-2175 or 800-344-3860 Toll Free USA/Canada
Fax: 303-675-2176 or 800-344-3867 Toll Free USA/Canada
Email: orderlit@onsemi.com

N. American Technical Support: 800-282-9855 Toll Free
USA/Canada
Europe, Middle East and Africa Technical Support:
Phone: 421 33 790 2910
Japan Customer Focus Center
Phone: 81-3-5817-1050

ON Semiconductor Website: www.onsemi.com
Order Literature: <http://www.onsemi.com/orderlit>
For additional information, please contact your local Sales Representative

Mouser Electronics

Authorized Distributor

Click to View Pricing, Inventory, Delivery & Lifecycle Information:

[ON Semiconductor:](#)

[1SMF5920BT1G](#)