

DATA SHEET

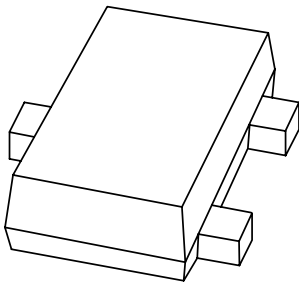

BZB984 series Voltage regulator double diodes

Product data sheet
Supersedes data of 2001 Nov 28

2002 Jun 21

Voltage regulator double diodes

BZB984 series

FEATURES

- Total power dissipation: max. 425 mW
- Approx. 5% V_Z tolerance
- Ultra small flat plastic SMD package
- Working voltage range nom. 2.4 to 15 V (E24 range).

APPLICATIONS

- General regulation functions
- ESD and surge protection.

DESCRIPTION

Low-power voltage regulator diodes in a SOT663 ultra small plastic SMD package.

PINNING

PIN	DESCRIPTION
1	cathode 1
2	cathode 2
3	common anode

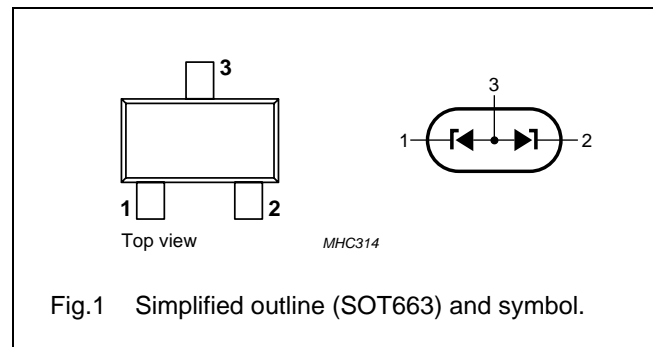

Fig.1 Simplified outline (SOT663) and symbol.

MARKING

TYPE NUMBER	MARKING CODE	TYPE NUMBER	MARKING CODE	TYPE NUMBER	MARKING CODE	TYPE NUMBER	MARKING CODE
BZB984-C2V4	91	BZB984-C3V9	96	BZB984-C6V2	9B	BZB984-C10	9G
BZB984-C2V7	92	BZB984-C4V3	97	BZB984-C6V8	9C	BZB984-C11	9H
BZB984-C3V0	93	BZB984-C4V7	98	BZB984-C7V5	9D	BZB984-C12	9J
BZB984-C3V3	94	BZB984-C5V1	99	BZB984-C8V2	9E	BZB984-C13	9K
BZB984-C3V6	95	BZB984-C5V6	9A	BZB984-C9V1	9F	BZB984-C15	9L

LIMITING VALUES

In accordance with the Absolute Maximum Rating System (IEC 60134).

SYMBOL	PARAMETER	CONDITIONS	MIN.	MAX.	UNIT
I_F	continuous forward current		–	200	mA
I_{ZSM}	non-repetitive peak reverse current	$t_p = 100 \mu s$; square wave; $T_{amb} = 25 \text{ }^\circ\text{C}$; prior to surge	see Table 1		
P_{tot}	total power dissipation	$T_{amb} = 25 \text{ }^\circ\text{C}$; 2 diodes loaded; note 1	–	425	mW
		$T_{amb} = 25 \text{ }^\circ\text{C}$; 1 diode loaded; note 1	–	265	mW
P_{ZSM}	non-repetitive peak reverse dissipation	$t_p = 100 \mu s$; square wave; $T_{amb} = 25 \text{ }^\circ\text{C}$; prior to surge	–	40	W
T_{stg}	storage temperature		–65	+150	$^\circ\text{C}$
T_j	junction temperature		–	150	$^\circ\text{C}$

Note

1. Device mounted on an FR4 printed-circuit board.

Voltage regulator double diodes

BZB984 series

ELECTRICAL CHARACTERISTICS**Total BZB984-C series**

$T_{amb} = 25\text{ °C}$ unless otherwise specified.

SYMBOL	PARAMETER	CONDITIONS	MAX.	UNIT
V_F	forward voltage	$I_F = 10\text{ mA}$; see Fig.2	0.9	V
I_R	reverse current			
	BZB984-C2V4	$V_R = 1\text{ V}$	50	μA
	BZB984-C2V7	$V_R = 1\text{ V}$	20	μA
	BZB984-C3V0	$V_R = 1\text{ V}$	10	μA
	BZB984-C3V3	$V_R = 1\text{ V}$	5	μA
	BZB984-C3V6	$V_R = 1\text{ V}$	5	μA
	BZB984-C3V9	$V_R = 1\text{ V}$	3	μA
	BZB984-C4V3	$V_R = 1\text{ V}$	3	μA
	BZB984-C4V7	$V_R = 2\text{ V}$	3	μA
	BZB984-C5V1	$V_R = 2\text{ V}$	2	μA
	BZB984-C5V6	$V_R = 2\text{ V}$	1	μA
	BZB984-C6V2	$V_R = 4\text{ V}$	3	μA
	BZB984-C6V8	$V_R = 4\text{ V}$	2	μA
	BZB984-C7V5	$V_R = 5\text{ V}$	1	μA
	BZB984-C8V2	$V_R = 5\text{ V}$	700	nA
	BZB984-C9V1	$V_R = 6\text{ V}$	500	nA
	BZB984-C10	$V_R = 7\text{ V}$	200	nA
	BZB984-C11	$V_R = 8\text{ V}$	100	nA
	BZB984-C12	$V_R = 8\text{ V}$	100	nA
	BZB984-C13	$V_R = 8\text{ V}$	100	nA
	BZB984-C15	$V_R = 10.5\text{ V}$	50	nA

Voltage regulator double diodes

BZB984 series

Table 1 Per type BZB984-C2V4 to C15 $T_j = 25\text{ °C}$ unless otherwise specified.

BZB984-Cxxx	WORKING VOLTAGE V_Z (V) at $I_Z = 5\text{ mA}$		DIFFERENTIAL RESISTANCE r_{dif} (Ω)				TEMP. COEFF. S_Z (mV/K) at $I_{Ztest} = 5\text{ mA}$ (see Figs 3 and 4)	DIODE CAP. C_d (pF) at $f = 1\text{ MHz}$; $V_R = 0\text{ V}$	NON-REPETITIVE PEAK REVERSE CURRENT I_{ZSM} (A) at $t_p = 100\text{ }\mu\text{s}$; $T_{amb} = 25\text{ °C}$
	Tol. $\approx 5\%$		at $I_Z = 1\text{ mA}$		at $I_Z = 5\text{ mA}$				
	MIN.	MAX.	TYP.	MAX.	TYP.	MAX.			
2V4	2.2	2.6	275	600	70	100	-1.3	450	6.0
2V7	2.5	2.9	300	600	75	100	-1.4	450	6.0
3V0	2.8	3.2	325	600	80	95	-1.6	450	6.0
3V3	3.1	3.5	350	600	85	95	-1.8	450	6.0
3V6	3.4	3.8	375	600	85	90	-1.9	450	6.0
3V9	3.7	4.1	400	600	85	90	-1.9	450	6.0
4V3	4.0	4.6	410	600	80	90	-1.7	450	6.0
4V7	4.4	5.0	425	500	50	80	-1.2	300	6.0
5V1	4.8	5.4	400	480	40	60	-0.5	300	6.0
5V6	5.2	6.0	80	400	15	40	1.0	300	6.0
6V2	5.8	6.6	40	150	6	10	2.2	200	6.0
6V8	6.4	7.2	30	80	6	15	3.0	200	6.0
7V5	7.0	7.9	30	80	6	15	3.6	150	4.0
8V2	7.7	8.7	40	80	6	15	4.3	150	4.0
9V1	8.5	9.6	40	100	6	15	5.2	150	3.0
10	9.4	10.6	50	150	8	20	6.0	90	3.0
11	10.4	11.6	50	150	10	20	6.9	90	2.5
12	11.4	12.7	50	150	10	25	7.9	85	2.5
13	12.4	14.1	50	170	10	30	8.8	80	2.5
15	13.8	15.6	50	200	10	30	10.7	75	2.0

Voltage regulator double diodes

BZB984 series

THERMAL CHARACTERISTICS

SYMBOL	PARAMETER	CONDITIONS	VALUE	UNIT
R _{th j-s}	thermal resistance from junction to soldering point	2 diodes loaded; note 1	125	K/W
		1 diode loaded; note 1	230	K/W
R _{th j-a}	thermal resistance from junction to ambient	2 diodes loaded; note 2	294	K/W
		1 diode loaded; note 2	472	K/W

Notes

1. Solder points on cathode tabs.
2. Device mounted on an FR4 printed-circuit board.

Soldering

The only recommended soldering method is reflow soldering.

GRAPHICAL DATA

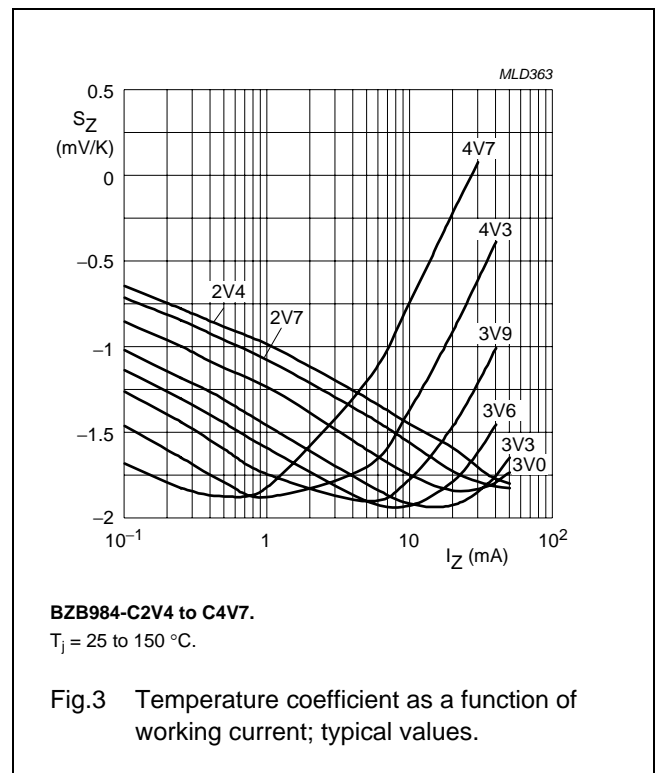
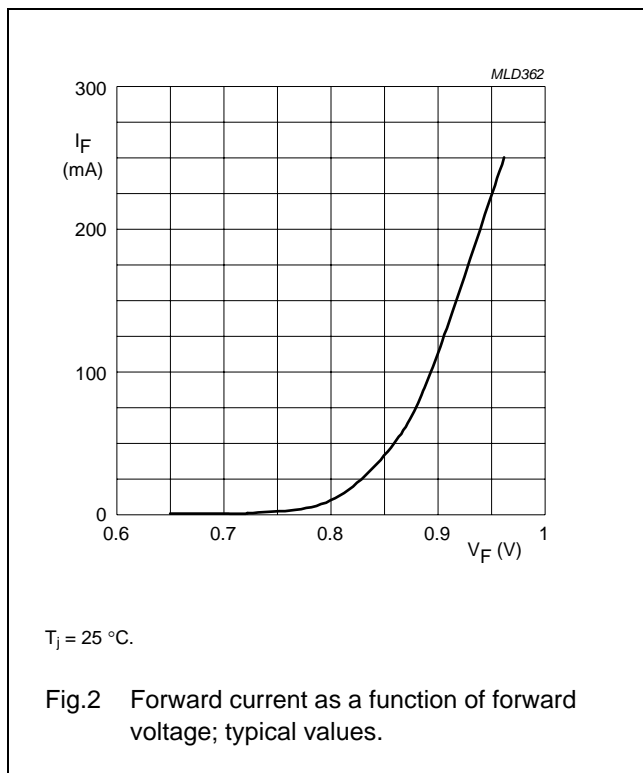

Voltage regulator double diodes

BZB984 series

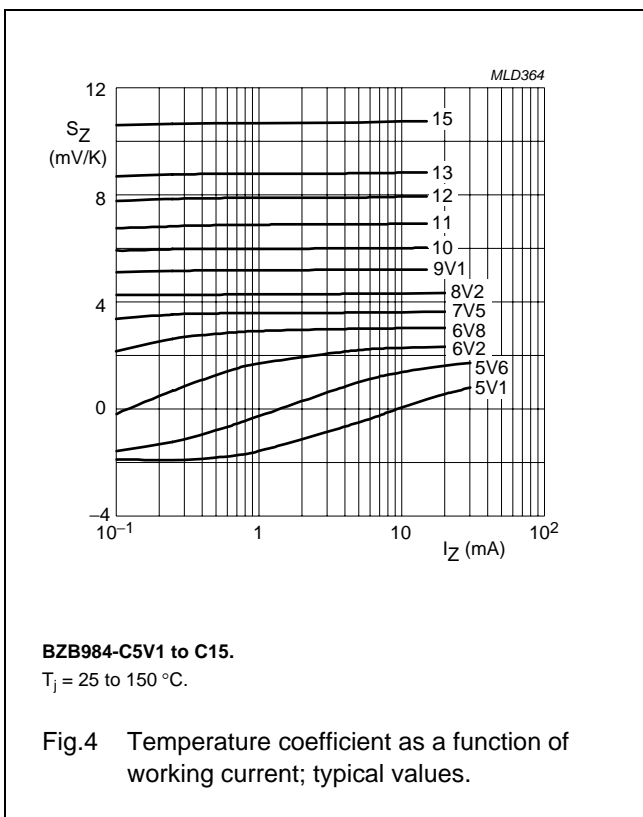

Voltage regulator double diodes

BZB984 series

PACKAGE OUTLINE

Plastic surface mounted package; 3 leads

SOT663

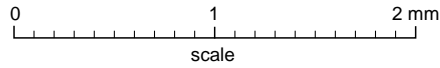
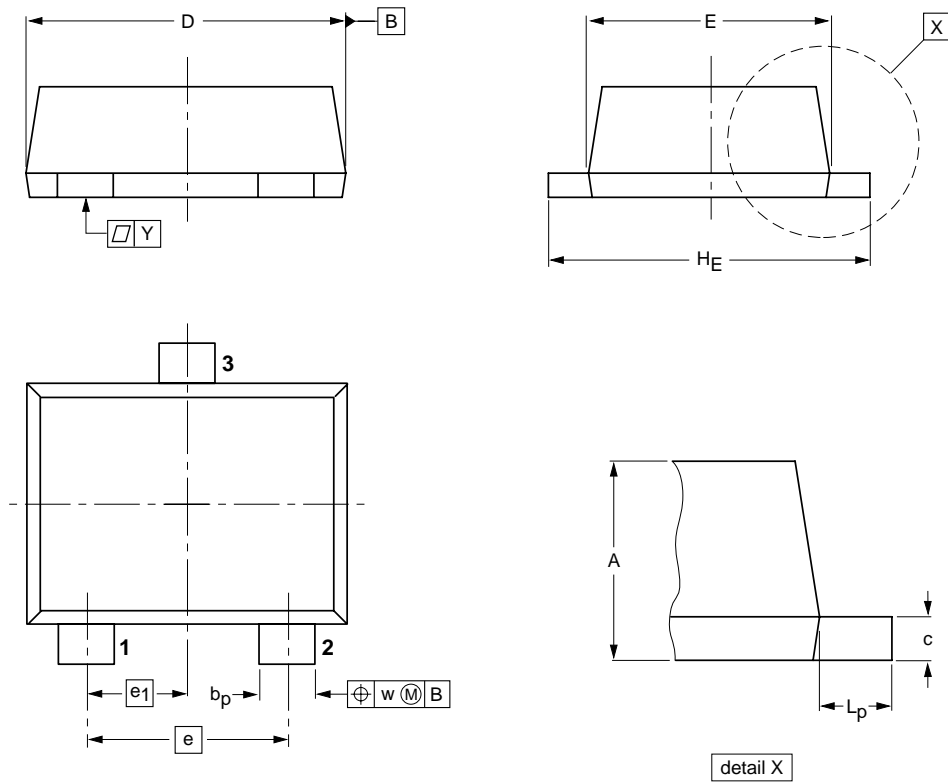

DIMENSIONS (mm are the original dimensions)

UNIT	A	b_p	c	D	E	e	e_1	H_E	L_p	w	y
mm	0.6 0.5	0.33 0.23	0.18 0.08	1.7 1.5	1.3 1.1	1.0	0.5	1.7 1.5	0.3 0.1	0.1	0.1

OUTLINE VERSION	REFERENCES				EUROPEAN PROJECTION	ISSUE DATE
	IEC	JEDEC	JEITA			
SOT663						01-12-04 02-05-21

Voltage regulator double diodes

BZB984 series

DATA SHEET STATUS

DOCUMENT STATUS ⁽¹⁾	PRODUCT STATUS ⁽²⁾	DEFINITION
Objective data sheet	Development	This document contains data from the objective specification for product development.
Preliminary data sheet	Qualification	This document contains data from the preliminary specification.
Product data sheet	Production	This document contains the product specification.

Notes

1. Please consult the most recently issued document before initiating or completing a design.
2. The product status of device(s) described in this document may have changed since this document was published and may differ in case of multiple devices. The latest product status information is available on the Internet at URL <http://www.nxp.com>.

DISCLAIMERS

General — Information in this document is believed to be accurate and reliable. However, NXP Semiconductors does not give any representations or warranties, expressed or implied, as to the accuracy or completeness of such information and shall have no liability for the consequences of use of such information.

Right to make changes — NXP Semiconductors reserves the right to make changes to information published in this document, including without limitation specifications and product descriptions, at any time and without notice. This document supersedes and replaces all information supplied prior to the publication hereof.

Suitability for use — NXP Semiconductors products are not designed, authorized or warranted to be suitable for use in medical, military, aircraft, space or life support equipment, nor in applications where failure or malfunction of an NXP Semiconductors product can reasonably be expected to result in personal injury, death or severe property or environmental damage. NXP Semiconductors accepts no liability for inclusion and/or use of NXP Semiconductors products in such equipment or applications and therefore such inclusion and/or use is at the customer's own risk.

Applications — Applications that are described herein for any of these products are for illustrative purposes only. NXP Semiconductors makes no representation or warranty that such applications will be suitable for the specified use without further testing or modification.

Limiting values — Stress above one or more limiting values (as defined in the Absolute Maximum Ratings System of IEC 60134) may cause permanent damage to the device. Limiting values are stress ratings only and operation of the device at these or any other conditions

above those given in the Characteristics sections of this document is not implied. Exposure to limiting values for extended periods may affect device reliability.

Terms and conditions of sale — NXP Semiconductors products are sold subject to the general terms and conditions of commercial sale, as published at <http://www.nxp.com/profile/terms>, including those pertaining to warranty, intellectual property rights infringement and limitation of liability, unless explicitly otherwise agreed to in writing by NXP Semiconductors. In case of any inconsistency or conflict between information in this document and such terms and conditions, the latter will prevail.

No offer to sell or license — Nothing in this document may be interpreted or construed as an offer to sell products that is open for acceptance or the grant, conveyance or implication of any license under any copyrights, patents or other industrial or intellectual property rights.

Export control — This document as well as the item(s) described herein may be subject to export control regulations. Export might require a prior authorization from national authorities.

Quick reference data — The Quick reference data is an extract of the product data given in the Limiting values and Characteristics sections of this document, and as such is not complete, exhaustive or legally binding.

NXP Semiconductors

Customer notification

This data sheet was changed to reflect the new company name NXP Semiconductors. No changes were made to the content, except for the legal definitions and disclaimers.

Contact information

For additional information please visit: **<http://www.nxp.com>**

For sales offices addresses send e-mail to: **salesaddresses@nxp.com**

© NXP B.V. 2009

All rights are reserved. Reproduction in whole or in part is prohibited without the prior written consent of the copyright owner.

The information presented in this document does not form part of any quotation or contract, is believed to be accurate and reliable and may be changed without notice. No liability will be accepted by the publisher for any consequence of its use. Publication thereof does not convey nor imply any license under patent- or other industrial or intellectual property rights.

Printed in The Netherlands

613514/02/pp9

Date of release: 2002 Jun 21

Document order number: 9397 750 09768



Mouser Electronics

Authorized Distributor

Click to View Pricing, Inventory, Delivery & Lifecycle Information:

NXP:

[BZB984-C10,115](#) [BZB984-C11,115](#) [BZB984-C12,115](#) [BZB984-C13,115](#) [BZB984-C15,115](#) [BZB984-C2V4,115](#)
[BZB984-C2V7,115](#) [BZB984-C3V0,115](#) [BZB984-C3V3,115](#) [BZB984-C3V6,115](#) [BZB984-C3V9,115](#) [BZB984-C4V3,115](#)
[BZB984-C4V7,115](#) [BZB984-C5V1,115](#) [BZB984-C5V6,115](#) [BZB984-C6V2,115](#) [BZB984-C6V8,115](#) [BZB984-](#)
[C7V5,115](#) [BZB984-C8V2,115](#) [BZB984-C9V1,115](#)