

BAV99 series

High-speed switching diodes

Rev. 8 — 18 November 2010

Product data sheet

1. Product profile

1.1 General description

High-speed switching diodes, encapsulated in small Surface-Mounted Device (SMD) plastic packages.

Table 1. Product overview

Type number	Package			Configuration	Package configuration
	NXP	JEITA	JEDEC		
BAV99	SOT23	-	TO-236AB	dual series	small
BAV99S	SOT363	SC-88	-	quadruple; 2 series	very small
BAV99W	SOT323	SC-70	-	dual series	very small

1.2 Features and benefits

- High switching speed: $t_{rr} \leq 4$ ns
- Low leakage current
- Small SMD plastic packages
- Low capacitance: $C_d \leq 1.5$ pF
- Reverse voltage: $V_R \leq 100$ V
- AEC-Q101 qualified

1.3 Applications

- High-speed switching
- General-purpose switching
- Reverse polarity protection

1.4 Quick reference data

Table 2. Quick reference data

Symbol	Parameter	Conditions	Min	Typ	Max	Unit
Per diode						
I_R	reverse current	$V_R = 80$ V	-	-	0.5	μ A
V_R	reverse voltage		-	-	100	V
t_{rr}	reverse recovery time		[1]	-	4	ns

[1] When switched from $I_F = 10$ mA to $I_R = 10$ mA; $R_L = 100$ Ω ; measured at $I_R = 1$ mA.



2. Pinning information

Table 3. Pinning

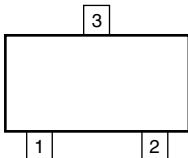
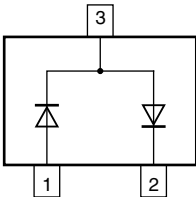
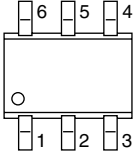
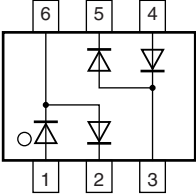
Pin	Description	Simplified outline	Graphic symbol
BAV99; BAV99W			
1	anode (diode 1)	 <p>006aaa144</p>	 <p>006aaa763</p>
2	cathode (diode 2)		
3	cathode (diode 1), anode (diode 2)		
BAV99S			
1	anode (diode 1)		 <p>006aab101</p>
2	cathode (diode 2)		
3	cathode (diode 3), anode (diode 4)		
4	anode (diode 3)		
5	cathode (diode 4)		
6	cathode (diode 1), anode (diode 2)		

3. Ordering information

Table 4. Ordering information

Type number	Package		Version
	Name	Description	
BAV99	-	plastic surface-mounted package; 3 leads	SOT23
BAV99S	SC-88	plastic surface-mounted package; 6 leads	SOT363
BAV99W	SC-70	plastic surface-mounted package; 3 leads	SOT323

4. Marking

Table 5. Marking codes

Type number	Marking code ^[1]
BAV99	A7*
BAV99S	K1*
BAV99W	A7*

[1] * = placeholder for manufacturing site code

5. Limiting values

Table 6. Limiting values

In accordance with the Absolute Maximum Rating System (IEC 60134).

Symbol	Parameter	Conditions	Min	Max	Unit		
Per diode							
V_{RRM}	repetitive peak reverse voltage		-	100	V		
V_R	reverse voltage		-	100	V		
I_F	forward current		[1]	-	215	mA	
			[2]	-	125	mA	
		BAV99S	[1]	-	200	mA	
		BAV99W	[1]	-	150	mA	
			[2]	-	130	mA	
I_{FRM}	repetitive peak forward current		-	500	mA		
I_{FSM}	non-repetitive peak forward current	square wave	[3]				
		$t_p = 1 \mu\text{s}$	-	4	A		
		$t_p = 1 \text{ms}$	-	1	A		
		$t_p = 1 \text{s}$	-	0.5	A		
P_{tot}	total power dissipation		[1][4]				
		BAV99	$T_{amb} \leq 25 \text{ }^\circ\text{C}$	-	250	mW	
		BAV99S	$T_{sp} \leq 85 \text{ }^\circ\text{C}$	[5]	-	250	mW
		BAV99W	$T_{amb} \leq 25 \text{ }^\circ\text{C}$	-	200	mW	
Per device							
T_j	junction temperature		-	150	$^\circ\text{C}$		
T_{amb}	ambient temperature		-65	+150	$^\circ\text{C}$		
T_{stg}	storage temperature		-65	+150	$^\circ\text{C}$		

[1] Single diode loaded.

[2] Double diode loaded.

[3] $T_j = 25 \text{ }^\circ\text{C}$ prior to surge.

[4] Device mounted on an FR4 Printed-Circuit Board (PCB), single-sided copper, tin-plated and standard footprint.

[5] Soldering points at pins 2, 3, 5 and 6.

6. Thermal characteristics

Table 7. Thermal characteristics

Symbol	Parameter	Conditions	Min	Typ	Max	Unit
$R_{th(j-a)}$	thermal resistance from junction to ambient	in free air	[1][2]			
	BAV99		-	-	500	K/W
	BAV99W		-	-	625	K/W
$R_{th(j-sp)}$	thermal resistance from junction to solder point					
	BAV99		-	-	360	K/W
	BAV99S		[3]	-	260	K/W
	BAV99W		-	-	300	K/W

[1] Single diode loaded.

[2] Device mounted on an FR4 PCB, single-sided copper, tin-plated and standard footprint.

[3] Soldering points at pins 2, 3, 5 and 6.

7. Characteristics

Table 8. Characteristics

$T_{amb} = 25\text{ }^{\circ}\text{C}$ unless otherwise specified.

Symbol	Parameter	Conditions	Min	Typ	Max	Unit
Per diode						
V_F	forward voltage	$I_F = 1\text{ mA}$	-	-	715	mV
		$I_F = 10\text{ mA}$	-	-	855	mV
		$I_F = 50\text{ mA}$	-	-	1	V
		$I_F = 150\text{ mA}$	-	-	1.25	V
I_R	reverse current	$V_R = 25\text{ V}$	-	-	30	nA
		$V_R = 80\text{ V}$	-	-	0.5	μA
		$V_R = 25\text{ V}; T_j = 150\text{ }^{\circ}\text{C}$	-	-	30	μA
		$V_R = 80\text{ V}; T_j = 150\text{ }^{\circ}\text{C}$	-	-	50	μA
C_d	diode capacitance	$f = 1\text{ MHz}; V_R = 0\text{ V}$	-	-	1.5	pF
t_{rr}	reverse recovery time		[1]	-	4	ns
V_{FR}	forward recovery voltage		[2]	-	1.75	V

[1] When switched from $I_F = 10\text{ mA}$ to $I_R = 10\text{ mA}$; $R_L = 100\text{ }\Omega$; measured at $I_R = 1\text{ mA}$.

[2] When switched from $I_F = 10\text{ mA}$; $t_r = 20\text{ ns}$.

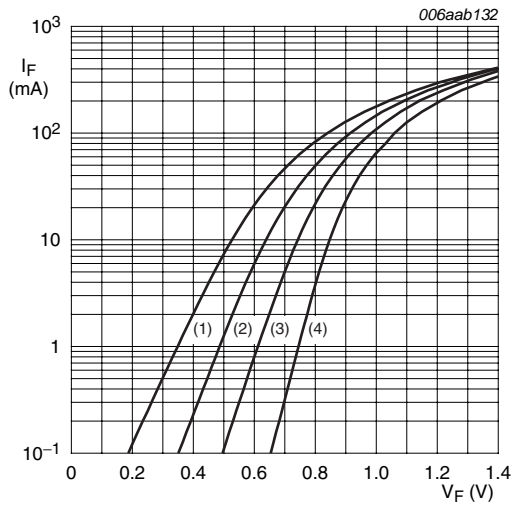

- (1) $T_{amb} = 150\text{ °C}$
- (2) $T_{amb} = 85\text{ °C}$
- (3) $T_{amb} = 25\text{ °C}$
- (4) $T_{amb} = -40\text{ °C}$

Fig 1. Forward current as a function of forward voltage; typical values

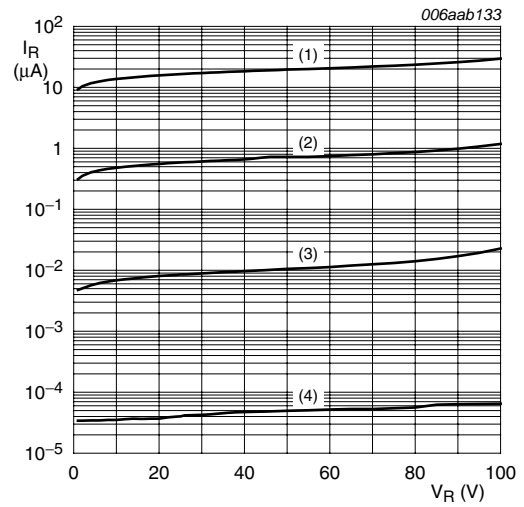

- (1) $T_{amb} = 150\text{ °C}$
- (2) $T_{amb} = 85\text{ °C}$
- (3) $T_{amb} = 25\text{ °C}$
- (4) $T_{amb} = -40\text{ °C}$

Fig 2. Reverse current as a function of reverse voltage; typical values

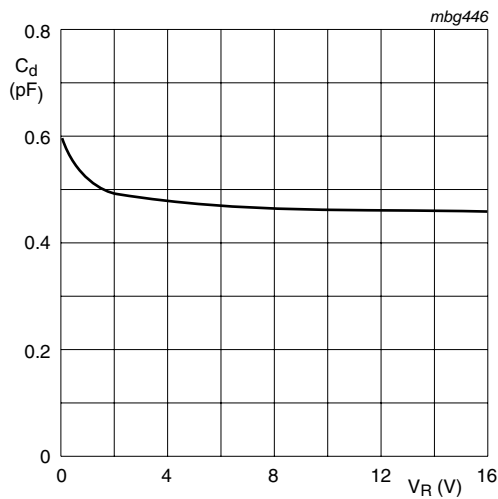

$f = 1\text{ MHz}; T_{amb} = 25\text{ °C}$

Fig 3. Diode capacitance as a function of reverse voltage; typical values

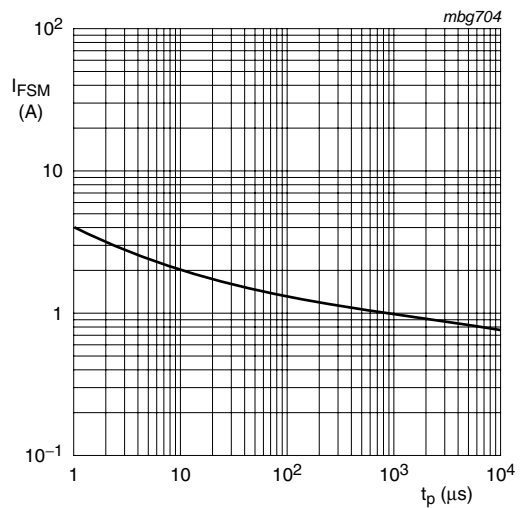

Based on square wave currents.

$T_j = 25\text{ °C};$ prior to surge

Fig 4. Non-repetitive peak forward current as a function of pulse duration; maximum values

8. Test information

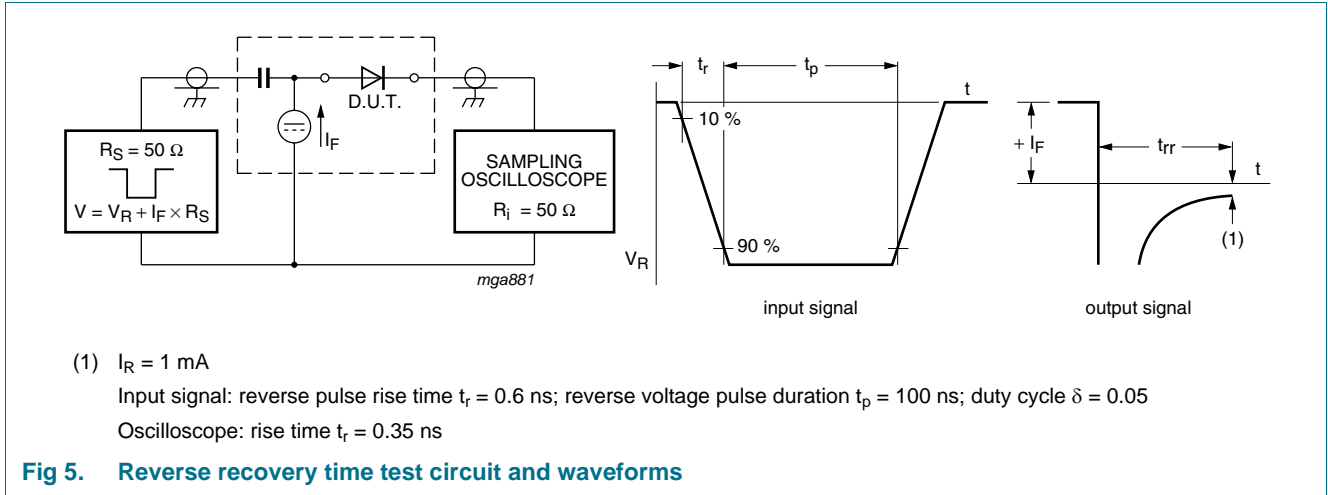

Fig 5. Reverse recovery time test circuit and waveforms

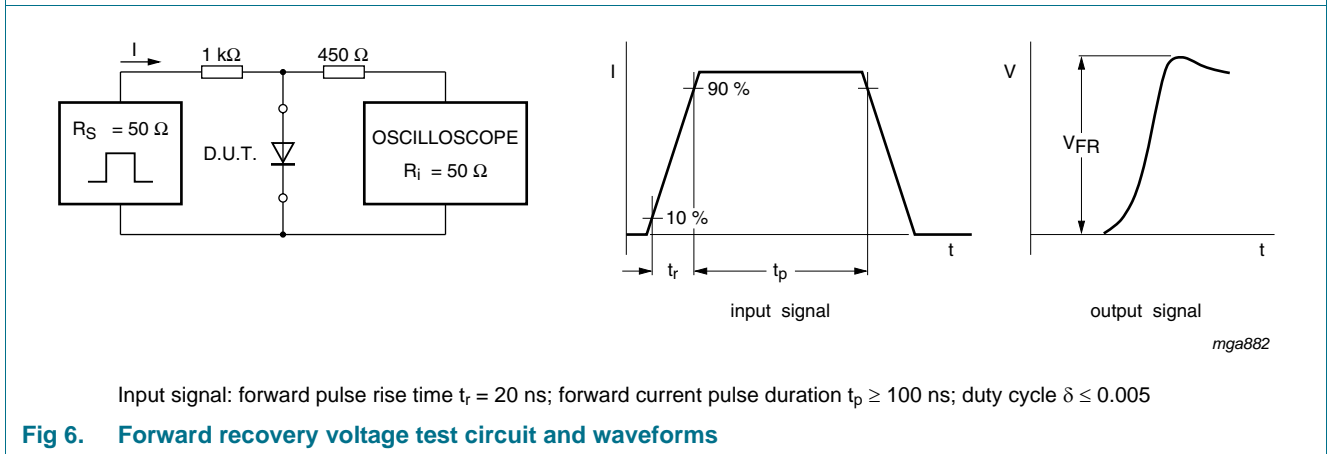

Fig 6. Forward recovery voltage test circuit and waveforms

8.1 Quality information

This product has been qualified in accordance with the Automotive Electronics Council (AEC) standard Q101 - *Stress test qualification for discrete semiconductors*, and is suitable for use in automotive applications.

9. Package outline

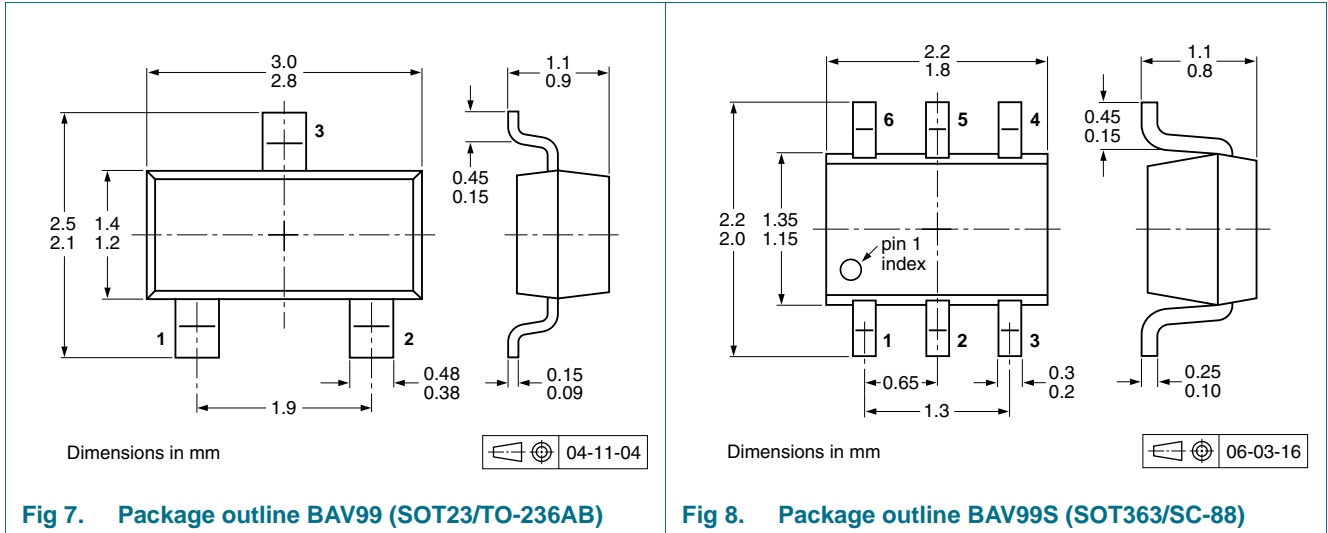

Fig 7. Package outline BAV99 (SOT23/TO-236AB)

Fig 8. Package outline BAV99S (SOT363/SC-88)

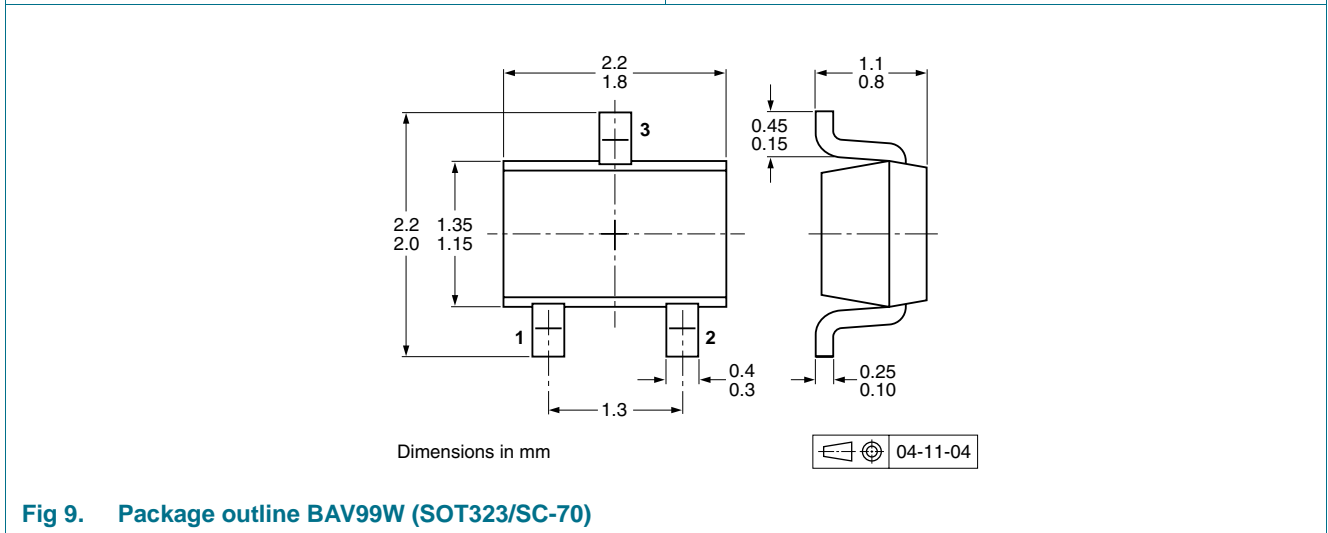

Fig 9. Package outline BAV99W (SOT323/SC-70)

10. Packing information

Table 9. Packing methods

The indicated -xxx are the last three digits of the 12NC ordering code.^[1]

Type number	Package	Description	Packing quantity	
			3000	10000
BAV99	SOT23	4 mm pitch, 8 mm tape and reel	-215	-235
BAV99S	SOT363	4 mm pitch, 8 mm tape and reel; T1	[2] -115	-135
		4 mm pitch, 8 mm tape and reel; T2	[3] -125	-165
BAV99W	SOT323	4 mm pitch, 8 mm tape and reel	-115	-135

[1] For further information and the availability of packing methods, see [Section 14](#).

[2] T1: normal taping

[3] T2: reverse taping

11. Soldering

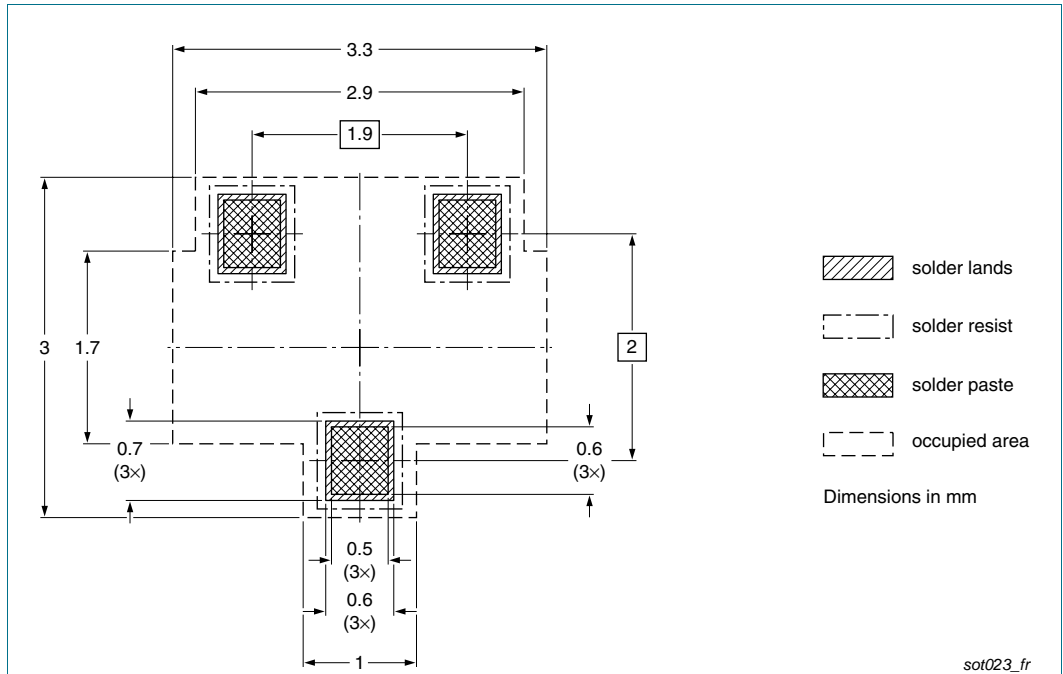

Fig 10. Reflow soldering footprint BAV99 (SOT23/TO-236AB)

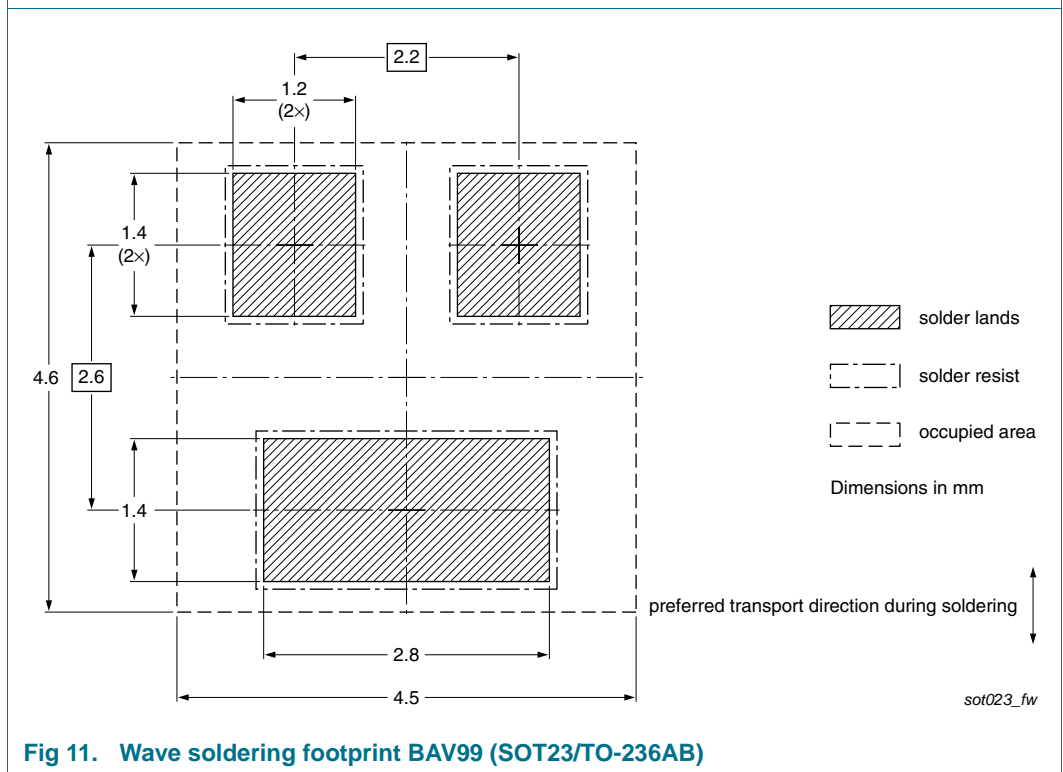

Fig 11. Wave soldering footprint BAV99 (SOT23/TO-236AB)

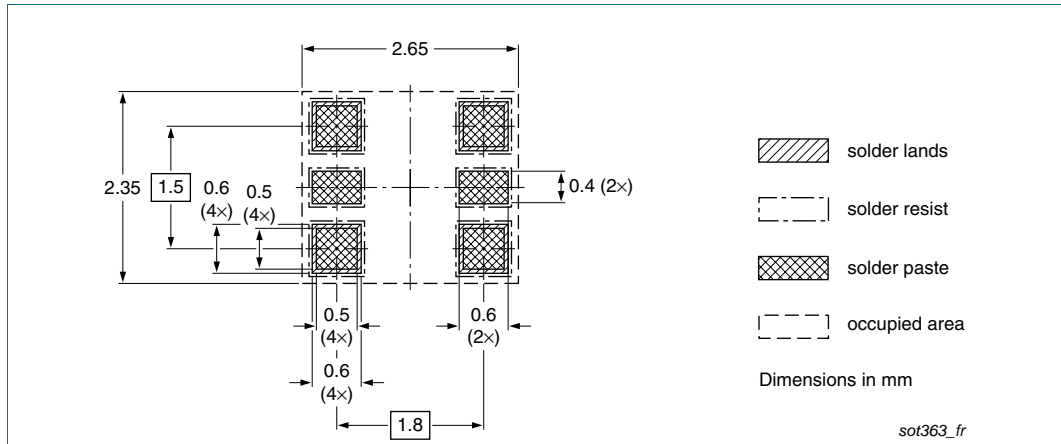

Fig 12. Reflow soldering footprint BAV99S (SOT363/SC-88)

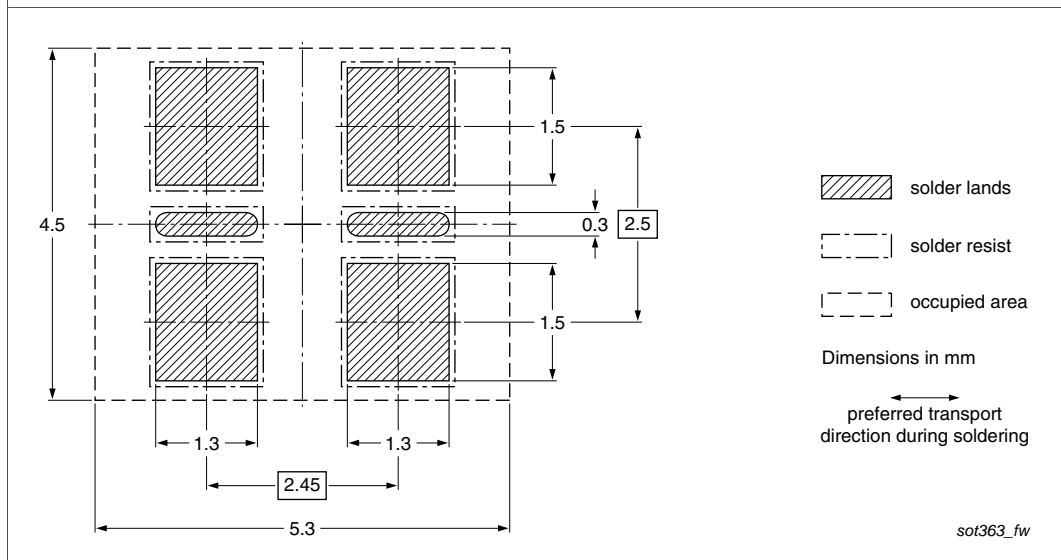

Fig 13. Wave soldering footprint BAV99S (SOT363/SC-88)

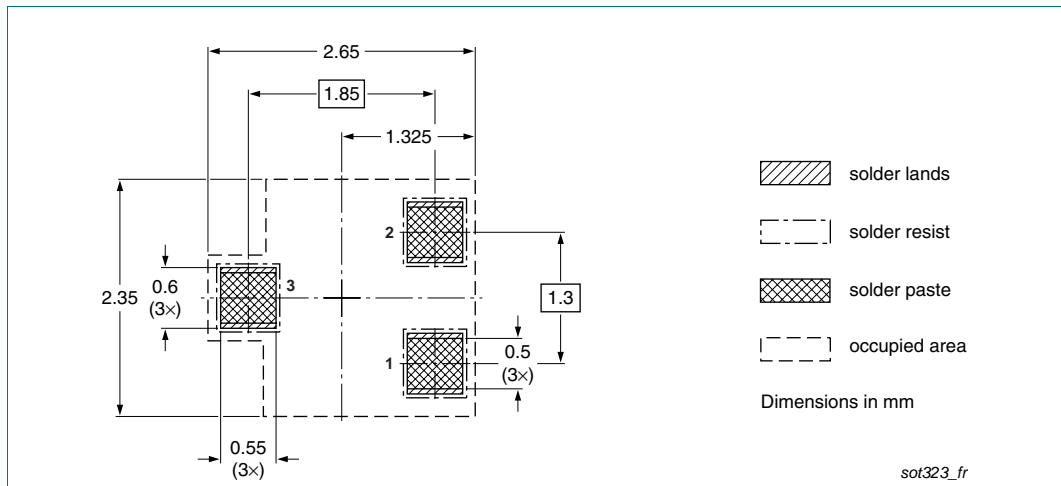

Fig 14. Reflow soldering footprint BAV99W (SOT323/SC-70)

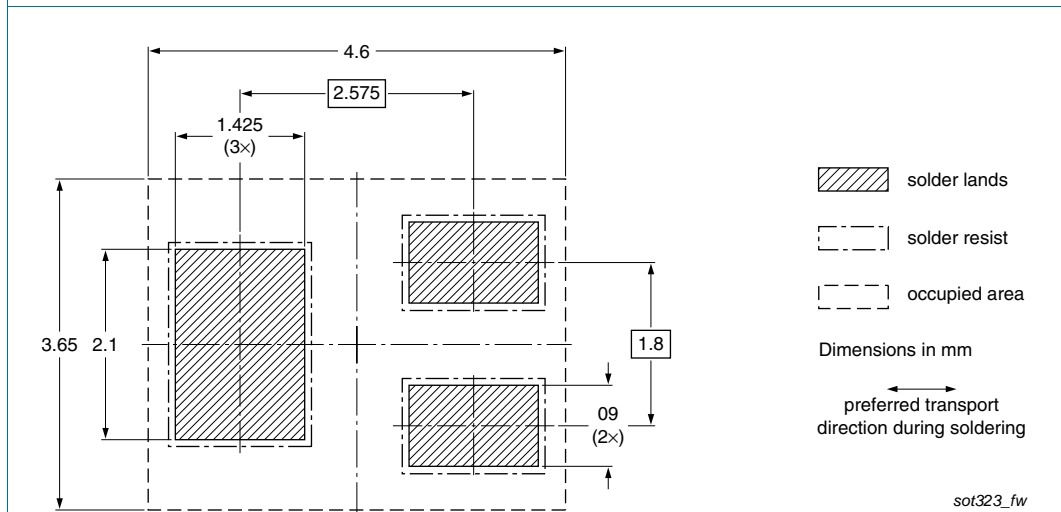

Fig 15. Wave soldering footprint BAV99W (SOT323/SC-70)

12. Revision history

Table 10. Revision history

Document ID	Release date	Data sheet status	Change notice	Supersedes
BAV99_SER_8	20101118	Product data sheet	-	BAV99_SER_7
Modifications:		<ul style="list-style-type: none"> • Section 4 "Marking": marking placeholder explanation in table footer updated • Section 5 "Limiting values": P_{tot} condition for BAV99S corrected • Section 13 "Legal information": updated 		
BAV99_SER_7	20100414	Product data sheet	-	BAV99_SER_6
BAV99_SER_6	20100310	Product data sheet	-	BAV99_SER_5
BAV99_SER_5	20080820	Product data sheet	-	BAV99_4 BAV99S_3 BAV99W_4
BAV99_4	20011015	Product specification	-	BAV99_3
BAV99S_3	20010514	Product specification	-	BAV99S_N_2
BAV99W_4	19990511	Product specification	-	BAV99W_3

13. Legal information

13.1 Data sheet status

Document status ^{[1][2]}	Product status ^[3]	Definition
Objective [short] data sheet	Development	This document contains data from the objective specification for product development.
Preliminary [short] data sheet	Qualification	This document contains data from the preliminary specification.
Product [short] data sheet	Production	This document contains the product specification.

[1] Please consult the most recently issued document before initiating or completing a design.

[2] The term 'short data sheet' is explained in section "Definitions".

[3] The product status of device(s) described in this document may have changed since this document was published and may differ in case of multiple devices. The latest product status information is available on the Internet at URL <http://www.nxp.com>.

13.2 Definitions

Draft — The document is a draft version only. The content is still under internal review and subject to formal approval, which may result in modifications or additions. NXP Semiconductors does not give any representations or warranties as to the accuracy or completeness of information included herein and shall have no liability for the consequences of use of such information.

Short data sheet — A short data sheet is an extract from a full data sheet with the same product type number(s) and title. A short data sheet is intended for quick reference only and should not be relied upon to contain detailed and full information. For detailed and full information see the relevant full data sheet, which is available on request via the local NXP Semiconductors sales office. In case of any inconsistency or conflict with the short data sheet, the full data sheet shall prevail.

Product specification — The information and data provided in a Product data sheet shall define the specification of the product as agreed between NXP Semiconductors and its customer, unless NXP Semiconductors and customer have explicitly agreed otherwise in writing. In no event however, shall an agreement be valid in which the NXP Semiconductors product is deemed to offer functions and qualities beyond those described in the Product data sheet.

13.3 Disclaimers

Limited warranty and liability — Information in this document is believed to be accurate and reliable. However, NXP Semiconductors does not give any representations or warranties, expressed or implied, as to the accuracy or completeness of such information and shall have no liability for the consequences of use of such information.

In no event shall NXP Semiconductors be liable for any indirect, incidental, punitive, special or consequential damages (including - without limitation - lost profits, lost savings, business interruption, costs related to the removal or replacement of any products or rework charges) whether or not such damages are based on tort (including negligence), warranty, breach of contract or any other legal theory.

Notwithstanding any damages that customer might incur for any reason whatsoever, NXP Semiconductors' aggregate and cumulative liability towards customer for the products described herein shall be limited in accordance with the *Terms and conditions of commercial sale* of NXP Semiconductors.

Right to make changes — NXP Semiconductors reserves the right to make changes to information published in this document, including without limitation specifications and product descriptions, at any time and without notice. This document supersedes and replaces all information supplied prior to the publication hereof.

Suitability for use — NXP Semiconductors products are not designed, authorized or warranted to be suitable for use in life support, life-critical or safety-critical systems or equipment, nor in applications where failure or

malfunction of an NXP Semiconductors product can reasonably be expected to result in personal injury, death or severe property or environmental damage. NXP Semiconductors accepts no liability for inclusion and/or use of NXP Semiconductors products in such equipment or applications and therefore such inclusion and/or use is at the customer's own risk.

Applications — Applications that are described herein for any of these products are for illustrative purposes only. NXP Semiconductors makes no representation or warranty that such applications will be suitable for the specified use without further testing or modification.

Customers are responsible for the design and operation of their applications and products using NXP Semiconductors products, and NXP Semiconductors accepts no liability for any assistance with applications or customer product design. It is customer's sole responsibility to determine whether the NXP Semiconductors product is suitable and fit for the customer's applications and products planned, as well as for the planned application and use of customer's third party customer(s). Customers should provide appropriate design and operating safeguards to minimize the risks associated with their applications and products.

NXP Semiconductors does not accept any liability related to any default, damage, costs or problem which is based on any weakness or default in the customer's applications or products, or the application or use by customer's third party customer(s). Customer is responsible for doing all necessary testing for the customer's applications and products using NXP Semiconductors products in order to avoid a default of the applications and the products or of the application or use by customer's third party customer(s). NXP does not accept any liability in this respect.

Limiting values — Stress above one or more limiting values (as defined in the Absolute Maximum Ratings System of IEC 60134) will cause permanent damage to the device. Limiting values are stress ratings only and (proper) operation of the device at these or any other conditions above those given in the Recommended operating conditions section (if present) or the Characteristics sections of this document is not warranted. Constant or repeated exposure to limiting values will permanently and irreversibly affect the quality and reliability of the device.

Terms and conditions of commercial sale — NXP Semiconductors products are sold subject to the general terms and conditions of commercial sale, as published at <http://www.nxp.com/profile/terms>, unless otherwise agreed in a valid written individual agreement. In case an individual agreement is concluded only the terms and conditions of the respective agreement shall apply. NXP Semiconductors hereby expressly objects to applying the customer's general terms and conditions with regard to the purchase of NXP Semiconductors products by customer.

No offer to sell or license — Nothing in this document may be interpreted or construed as an offer to sell products that is open for acceptance or the grant, conveyance or implication of any license under any copyrights, patents or other industrial or intellectual property rights.

Export control — This document as well as the item(s) described herein may be subject to export control regulations. Export might require a prior authorization from national authorities.

Quick reference data — The Quick reference data is an extract of the product data given in the Limiting values and Characteristics sections of this document, and as such is not complete, exhaustive or legally binding.

13.4 Trademarks

Notice: All referenced brands, product names, service names and trademarks are the property of their respective owners.

14. Contact information

For more information, please visit: <http://www.nxp.com>

For sales office addresses, please send an email to: salesaddresses@nxp.com

15. Contents

1	Product profile	1
1.1	General description	1
1.2	Features and benefits	1
1.3	Applications	1
1.4	Quick reference data	1
2	Pinning information	2
3	Ordering information	2
4	Marking	2
5	Limiting values	3
6	Thermal characteristics	4
7	Characteristics	4
8	Test information	6
8.1	Quality information	6
9	Package outline	7
10	Packing information	7
11	Soldering	8
12	Revision history	11
13	Legal information	12
13.1	Data sheet status	12
13.2	Definitions	12
13.3	Disclaimers	12
13.4	Trademarks	13
14	Contact information	13
15	Contents	14

Please be aware that important notices concerning this document and the product(s) described herein, have been included in section 'Legal information'.

© NXP B.V. 2010.

All rights reserved.

For more information, please visit: <http://www.nxp.com>

For sales office addresses, please send an email to: salesaddresses@nxp.com

Date of release: 18 November 2010

Document identifier: BAV99_SER

Mouser Electronics

Authorized Distributor

Click to View Pricing, Inventory, Delivery & Lifecycle Information:

[NXP:](#)

[BAV99/8,235](#) [BAV99/8,215](#)