

# Shunt Mode Audio Click-and-Pop Eliminator

## General Description

The MAX9892 is an audio click-and-pop eliminator for portable multimedia devices. Operating from a 1.7V to 3.6V supply, the MAX9892 connects to the output of the existing system amplifier and provides a low-impedance path to ground during startup and shutdown. The inputs INL and INR accept voltage swings from  $V_{DD}$  to 5.5V below  $V_{DD}$ . See the *Setting the Supply Voltage* section for more information. The power-up and power-down transients are shunted to ground to prevent clicks and pops from becoming audible.

The MAX9892 features two low-impedance analog switches controlled by MUTE that opens and closes the switches. The switches are open during normal operation and have no impact on the output signal. During startup and shutdown of the amplifier, the MAX9892 can be activated to short the outputs to ground and prevent clicks and pops from pulling current through the headphones.

The MAX9892 is available in 6-bump UCSP (1mm x 1.52mm x 0.6mm) and 6-pin  $\mu$ DFN (2mm x 2mm x 0.75mm) packages. The MAX9892 is specified over the -40°C to +85°C temperature range.

## Applications

Mobile Phones  
Smart Phones  
Mobile Internet Devices  
Portable Gaming Consoles  
Portable Media Players  
Notebook Computers

## Typical Operating Circuit

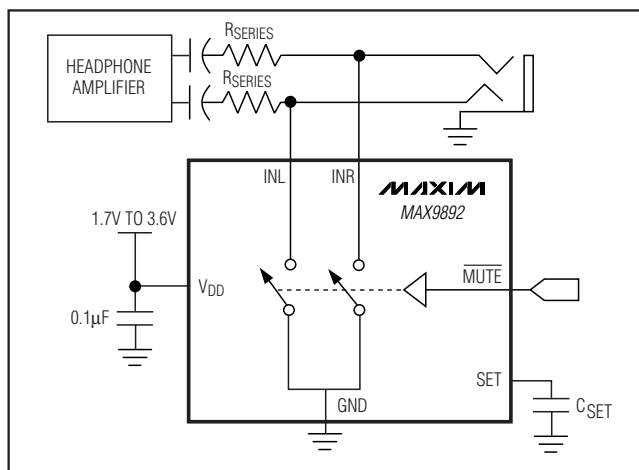

## Features

- ◆ Distortion-Free, Click-and-Pop Elimination
- ◆ Less than 1 $\mu$ A Supply Current
- ◆ 1.7V to 3.6V Single-Supply Operation
- ◆ Tiny Packages
  - 6-Bump UCSP (1mm x 1.52mm x 0.6mm)
  - 6-Pin  $\mu$ DFN (2mm x 2mm x 0.75mm)

## Ordering Information

PART	TEMP RANGE	PIN-PACKAGE
MAX9892ERT+	-40°C to +85°C	6 UCSP
MAX9892ELT+	-40°C to +85°C	6 $\mu$ DFN

+Denotes a lead-free/RoHS-compliant package.

## Pin Configurations

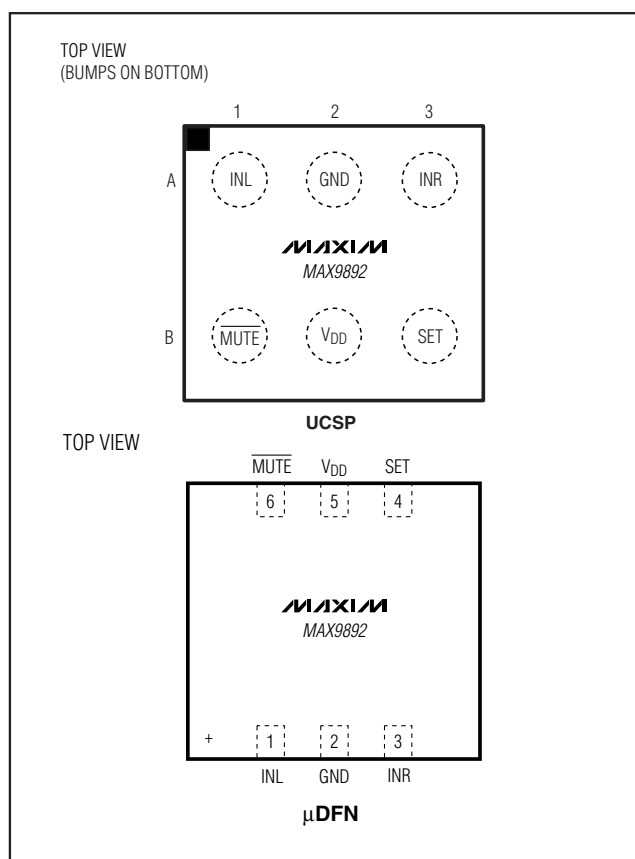

# Shunt Mode Audio Click-and-Pop Eliminator

## ABSOLUTE MAXIMUM RATINGS

$V_{DD}$ ,  $\overline{MUTE}$ , SET to GND ..... -0.3V to +6V  
 INL, INR to GND ..... (V<sub>DD</sub> - 6V) to (V<sub>DD</sub> + 0.3V)  
 Continuous Current In/Out of  $V_{DD}$  ..... 30mA  
 Continuous Current In/Out of  $\overline{MUTE}$  ..... 30mA  
 Continuous Current In/Out of SET ..... 30mA  
 Continuous Current In/Out of INL, INR and GND ..... 390mA  
 Continuous Power Dissipation (T<sub>A</sub> = +70°C)  
   6-Bump UCSP (derate 3.9mW/°C above +70°C) ..... 308.3mW  
   6-Pin  $\mu$ DFN (derate 4.5mW/°C above +70°C) ..... 357.8mW

Operating Temperature Range ..... -40°C to +85°C  
 Junction Temperature ..... +150°C  
 Storage Temperature Range ..... -65°C to +150°C  
 Lead Temperature (soldering, 10s) ..... +300°C  
 Bump Temperature (soldering)  
   Reflow ..... +235°C

Stresses beyond those listed under "Absolute Maximum Ratings" may cause permanent damage to the device. These are stress ratings only, and functional operation of the device at these or any other conditions beyond those indicated in the operational sections of the specifications is not implied. Exposure to absolute maximum rating conditions for extended periods may affect device reliability.

## ELECTRICAL CHARACTERISTICS

(V<sub>DD</sub> = 3.0V, V<sub>GND</sub> = 0, T<sub>A</sub> = T<sub>MIN</sub> to T<sub>MAX</sub>, unless otherwise noted. Typical values are at T<sub>A</sub> = +25°C.) (Note 1)

PARAMETER	SYMBOL	CONDITIONS	MIN	TYP	MAX	UNITS
Supply Voltage Range	V <sub>DD</sub>	Guaranteed by R <sub>ON</sub> test	1.7		5.5	V
Recommended Supply Voltage Range	V <sub>DD</sub>	(Note 2)	1.7		3.6	V
Supply Current	I <sub>DD</sub>	V <sub>DD</sub> = 5.5V, T <sub>A</sub> = +25°C (Note 3)		0.6	1	$\mu$ A
Input Voltage Range	V <sub>IN</sub>	Guaranteed by input leakage current test	V <sub>DD</sub> - 5.5V		V <sub>DD</sub>	V
Turn-On Time (Figure 1)	t <sub>ON</sub>	Measured from $\overline{MUTE}$ = GND and input voltage settled to 90% of its final value		130		ns
Turn-Off Time (Figure 1)	t <sub>OFF</sub>	C <sub>SET</sub> = 500pF	4	10	17	ms
		C <sub>SET</sub> = 50pF		1		
		C <sub>SET</sub> = 50nF		1000		
Turn-On Time Resistor	R <sub>SET</sub>	C <sub>SET</sub> = 500pF	350	800	1300	k $\Omega$
Switch On-Resistance	R <sub>ON</sub>	V <sub>DD</sub> = 3.0V		0.3		$\Omega$
		V <sub>DD</sub> = 1.7V			2	
		V <sub>DD</sub> = 5.5V			1	
Click-and-Pop Reduction		R <sub>SERIES</sub> = 30 $\Omega$ , R <sub>LOAD</sub> = 16 $\Omega$		35		dB
Input Leakage Current	I <sub>IN</sub>	T <sub>A</sub> = +25°C	V <sub>IN</sub> = V <sub>DD</sub> - 5.5V, V <sub>DD</sub> = 1.7V		$\pm$ 1	$\mu$ A
			V <sub>IN</sub> = V <sub>DD</sub> , V <sub>DD</sub> = 5.5V		$\pm$ 1	
$\overline{MUTE}$ Leakage Current	I <sub>MUTE</sub>	V <sub>DD</sub> = 5.5V, V <sub>MUTE</sub> = 0 or 5.5V, T <sub>A</sub> = +25°C			$\pm$ 1	$\mu$ A
$\overline{MUTE}$ Input-Voltage High	V <sub>IH</sub>		1.5			V
$\overline{MUTE}$ Input-Voltage Low	V <sub>IL</sub>				0.4	V

**Note 1:** All devices are 100% production tested at T<sub>A</sub> = +25°C. All temperature limits are guaranteed by design.

**Note 2:** Operating within the recommended supply voltage range ensures that negative audio signals are not limited by the device.

Supply voltages above the recommended supply voltage range may limit the headphone amplifier's maximum output voltage.

**Note 3:** Supply current is measured when switches are off.

# Shunt Mode Audio Click-and-Pop Eliminator

## Typical Operating Characteristics

( $V_{DD} = 3.0V$ ,  $V_{GND} = 0$ ,  $T_A = +25^\circ C$ , unless otherwise noted.)

MAX9892

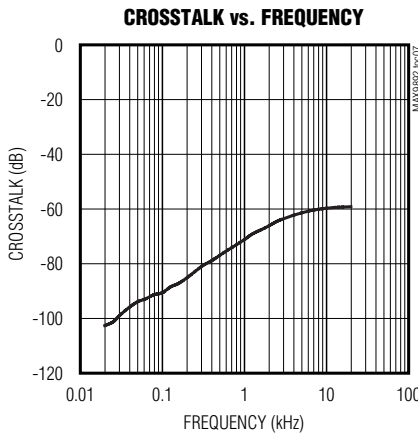
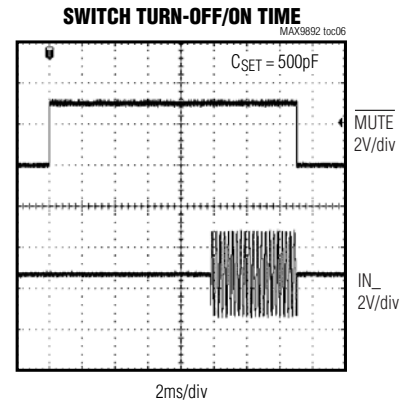
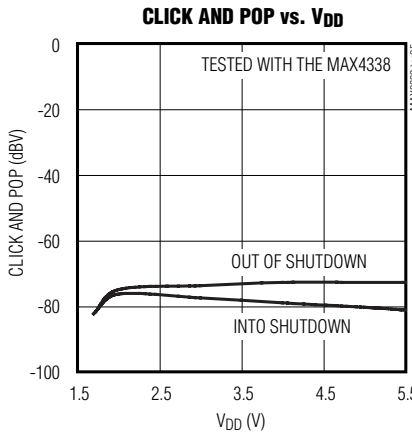
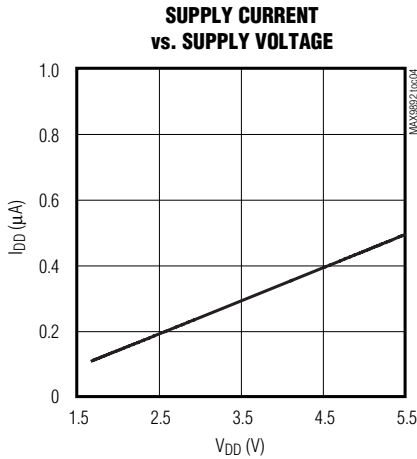
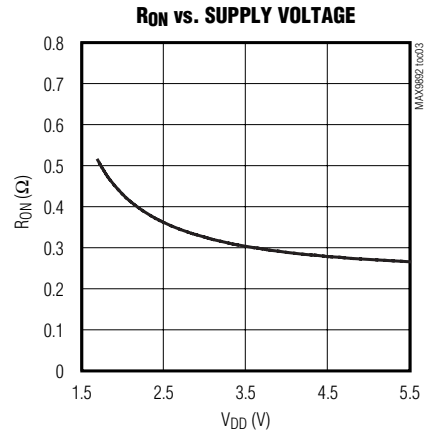
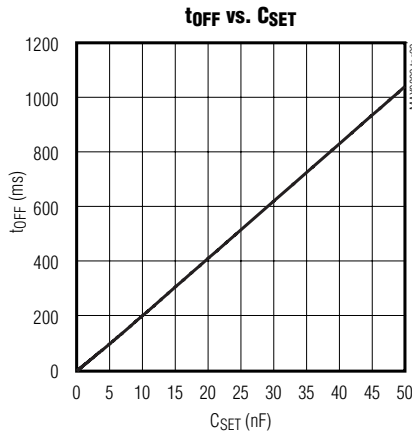
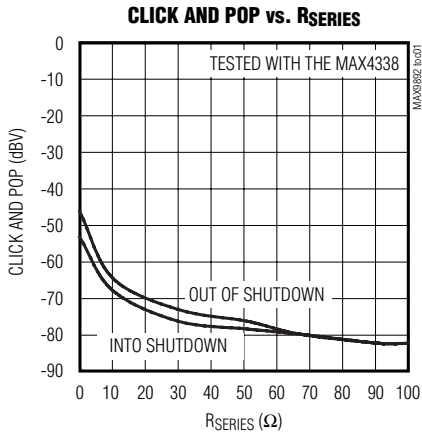

# Shunt Mode Audio Click-and-Pop Eliminator

## Pin Description

UCSP	$\mu$ DFN	NAME	FUNCTION
BUMP	PIN		
A1	1	INL	Left-Channel Input. Connect INL in between the output coupling capacitor and the headphone jack.
A2	2	GND	Ground
A3	3	INR	Right-Channel Input. Connect INR in between the output coupling capacitor and the headphone jack.
B1	6	MUTE	Active-Low Enable
B2	5	VDD	Power Supply
B3	4	SET	Turn-Off Time Set. Connect an external capacitor in between SET and GND to set the switch open delay; see the <i>Setting the Turn-Off Time</i> section for more information.

## Timing Diagram

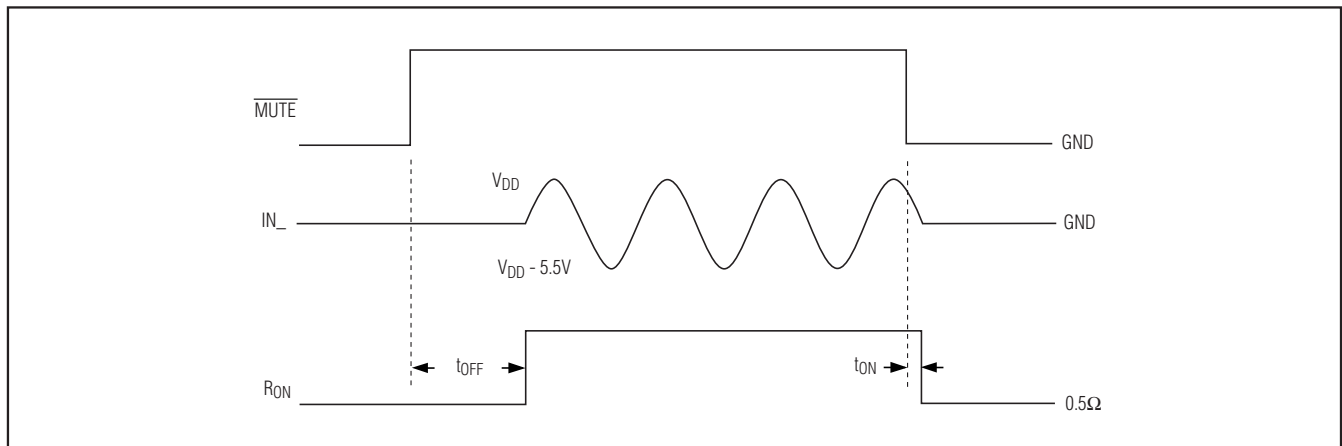

Figure 1. Turn-On/Off Time

# Shunt Mode Audio Click-and-Pop Eliminator

## Detailed Description

The MAX9892 is the second-generation click-and-pop eliminator designed to be used with conventional headphone amplifiers. The MAX9892 works by adding a low-impedance current path from the headphone side of the DC-blocking capacitor to ground. Drive  $\overline{\text{MUTE}}$  low when turning off the amplifier, and high when enabling the amplifier. A short turn-on time allows the switches in the MAX9892 to close before the DC-blocking capacitors have significantly discharged, eliminating clicks and pops at amplifier turn-off. An adjustable turn-off time allows the delay to be set to mask all clicks and pops during amplifier turn-on.

### Setting the Turn-Off Time

The MAX9892 features a SET input that allows the turn-off time to be adjusted from 1ms to 1000ms to match the click-and-pop profile of the amplifier startup. The value of an external capacitor sets the switch open delay, as shown in the following equation:

$$t_{\text{ON}} (\text{ms}) = 0.02 \times C_{\text{SET}} (\text{pF})$$

When the headphone amplifier is enabled, the MAX9892 automatically waits the set delay time before opening the analog switches. This allows amplifier turn-on click and pop to be eliminated.

## Applications Information

### Setting the Supply Voltage

The MAX9892 operates from 1.7V to 3.6V supply voltage. The inputs, INL and INR, accept voltage swings from  $V_{\text{DD}}$  to  $V_{\text{DD}} - 5.5\text{V}$ . The audio signal applied to a headphone is ground biased, meaning that the signal swings just as much negative as positive. Since the MAX9892 input voltage is limited to  $V_{\text{DD}} - 5.5\text{V}$  on the negative side, the voltage on  $V_{\text{DD}}$  must be set properly to pass the audio signal when the switch is open (Figure 2).

A voltage-divider can be used to scale down an available supply voltage as shown in Figure 3. The voltage-divider allows the creation of a supply voltage for the MAX9892 that is low enough to allow the negative portion of the audio signal to pass. When using large resistances for the voltage-divider, the supply current affects what resistors to use. Select  $R_2$  between 10k $\Omega$  to 1M $\Omega$  for a given supply voltage. Use the following equation to calculate the  $R_1$ :

$$R_1 = \frac{(V_{\text{AMP}} - V_{\text{DD}})}{I_2 + I_{\text{DD}}}$$

where  $V_{\text{AMP}}$  is the supply voltage of the amplifier, and  $I_2$  is the current through  $R_2$ . For a signal of  $\pm 2\text{V}$  in reference to GND, the MAX9892 supply can be set from 2V to 3.5V.

### Selecting Series Resistors

A series resistor ( $R_{\text{SERIES}}$ ), as shown in the *Typical Operating Circuit*, is necessary to achieve optimal click-and-pop reduction. See the Click and Pop vs.  $R_{\text{SERIES}}$  graph in the *Typical Operating Characteristics* for details on how much click-and-pop reduction to expect for a given series resistor.

### Layout Considerations

Bypass  $V_{\text{DD}}$  to GND with a 0.1 $\mu\text{F}$  capacitor. The 0.1 $\mu\text{F}$  bypass capacitor should be positioned as close as possible to  $V_{\text{DD}}$ . Minimize trace length from GND to solid system ground plane to ensure optimum performance.

Refer to the MAX9892 Evaluation Kit for a proven PCB layout.

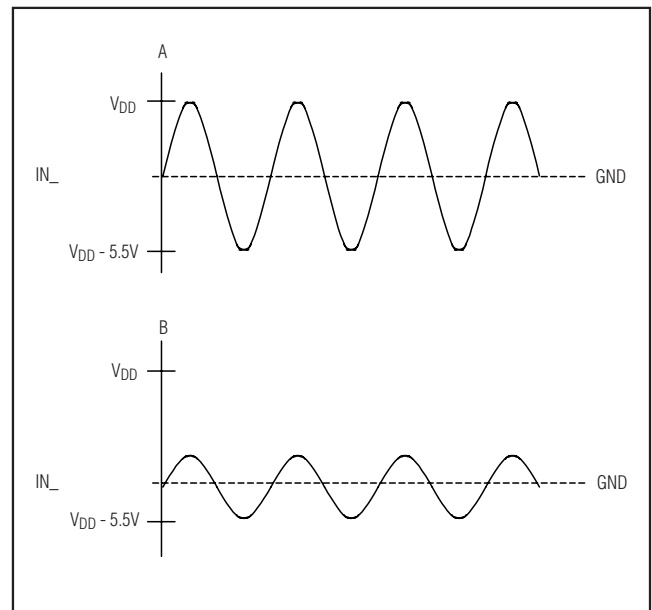

Figure 2. Proper Supply Selected for a Given Input Signal.  
A: Supply Voltage with a Large Signal;  
B: Supply Voltage with a Small Signal

# Shunt Mode Audio Click-and-Pop Eliminator

## UCSP Applications Information

For the latest application details on UCSP construction, dimensions, tape-carrier information, printed circuit board techniques, bump-pad layout, and recommended reflow temperature profile, as well as the latest information on reliability testing results, refer to Application Note 1891: *Understanding the Basics of the Wafer-Level Chip-Scale Package (WL-CSP)* at [www.maxim-ic.com/ucsp](http://www.maxim-ic.com/ucsp). See Figure 4 for the recommended MAX9892 PCB footprint.

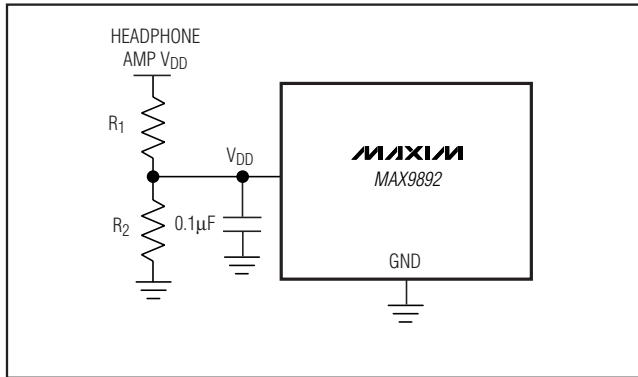

Figure 3. Scaling Down the Supply Voltage with a Voltage Divider

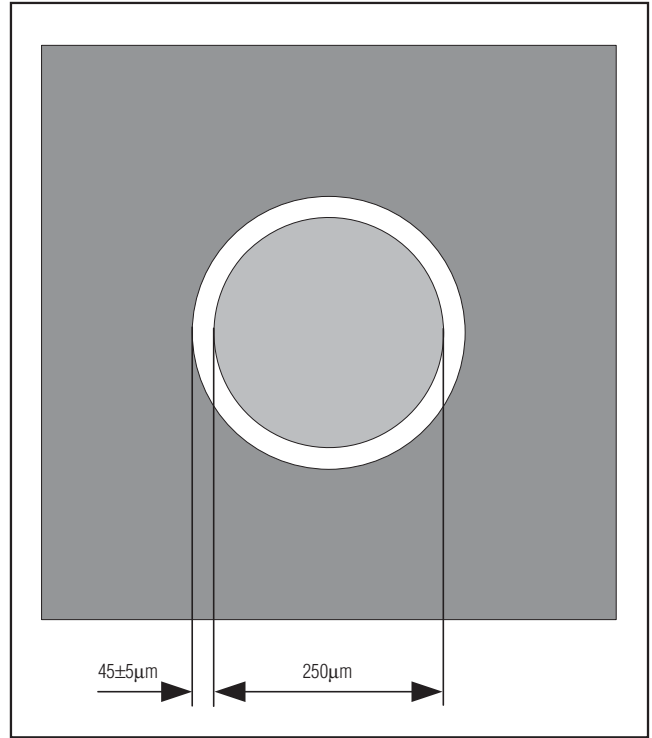

Figure 4. PCB Footprint Recommendation Diagram

## Chip Information

PROCESS: BiCMOS

# Shunt Mode Audio Click-and-Pop Eliminator

## Package Information

For the latest package outline information and land patterns, go to [www.maxim-ic.com/packages](http://www.maxim-ic.com/packages).

MAX9892

PACKAGE TYPE	PACKAGE CODE	DOCUMENT NO.
6 UCSP	R6-1A1+1	<a href="#">21-0228</a>
6 $\mu$ DFN	L622-1	<a href="#">21-0164</a>

TOP VIEW

COMMON DIMENSIONS	
A	0.64±0.05
A1	0.24±0.03
b	∅0.30 REF
D1	0.50 BASIC
E1	1.00 BASIC
e	0.50 BASIC
SD	0.25 BASIC
SE	0.00 BASIC

PKG. CODE	VARIABLE DIMENSIONS		DEPOPULATED BUMPS
	E	D	
R61A1+1	1.52±0.05	1.00±0.05	NONE
R61B1+1	1.57±0.05	1.05±0.05	NONE
R61C1+1	1.57±0.05	1.16±0.05	NONE

SIDE VIEW

BOTTOM VIEW

NOTES:

- Terminal pitch is defined by terminal center to center value.
- Outer dimension (D & E) is defined by center lines between scribe lines.
- All dimensions in millimeters.
- Marking shown is for package orientation reference only.
- Tolerance is ± 0.02mm unless specified otherwise.
- All dimensions apply to PbFree (+) package codes only.

—DRAWING NOT TO SCALE—

TITLE: PACKAGE OUTLINE 6 BUMPS, 2x3 ARRAY, UCSP (R) PKG.		
APPROVAL	DOCUMENT CONTROL NO. 21-0228	REV. A 1/1

UCSP.EPS

# Shunt Mode Audio Click-and-Pop Eliminator

## Package Information (continued)

For the latest package outline information and land patterns, go to [www.maxim-ic.com/packages](http://www.maxim-ic.com/packages).

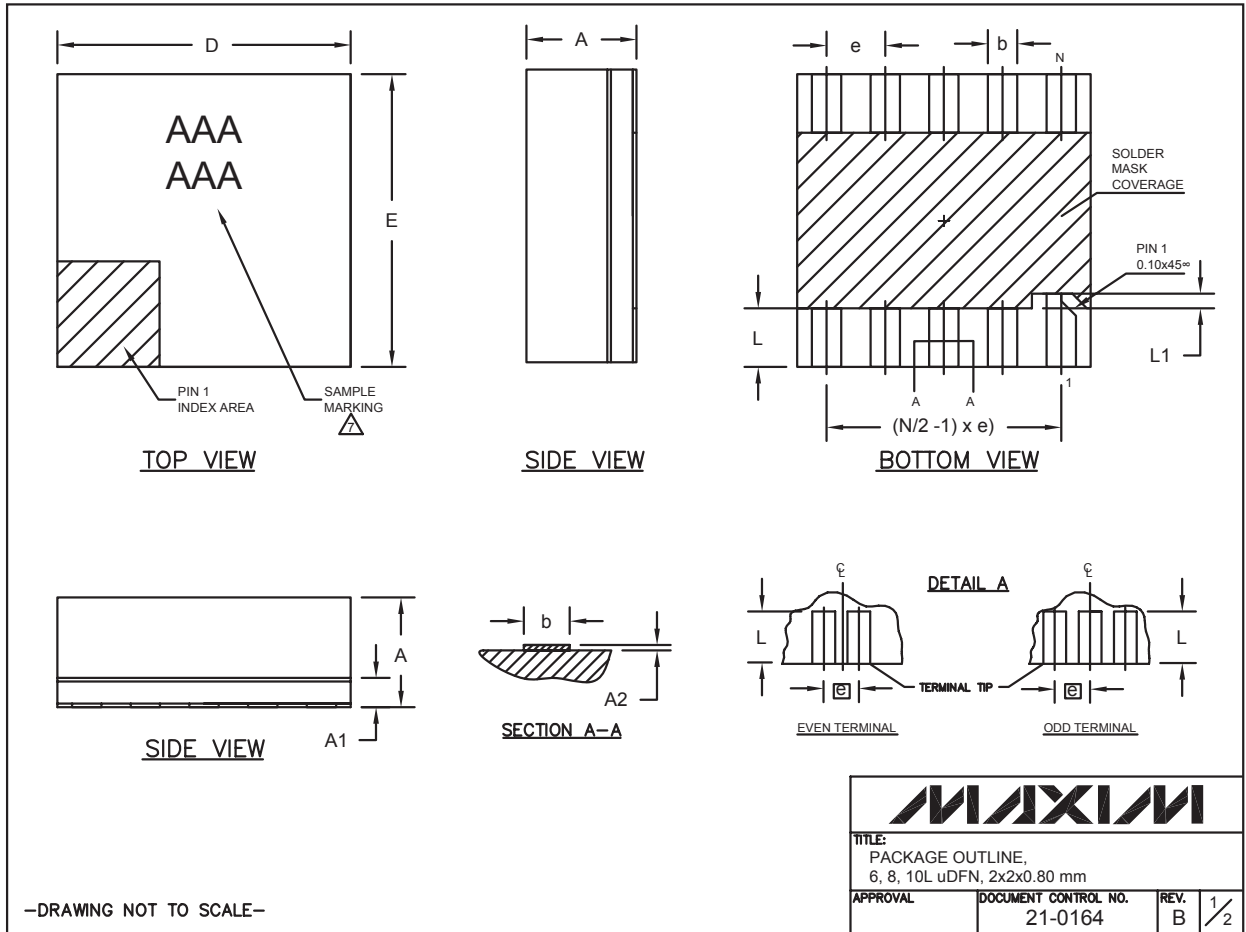



# Shunt Mode Audio Click-and-Pop Eliminator

## Package Information (continued)

For the latest package outline information and land patterns, go to [www.maxim-ic.com/packages](http://www.maxim-ic.com/packages).

MAX9892

COMMON DIMENSIONS			
SYMBOL	MIN.	NOM.	MAX.
A	0.70	0.75	0.80
A1	0.15	0.20	0.25
A2	0.020	0.025	0.035
D	1.95	2.00	2.05
E	1.95	2.00	2.05
L	0.30	0.40	0.50
L1	0.10 REF.		

PACKAGE VARIATIONS				
PKG. CODE	N	e	b	(N/2 -1) x e
L622-1	6	0.65 BSC	0.30±0.05	1.30 REF.
L822-1	8	0.50 BSC	0.25±0.05	1.50 REF.
L1022-1	10	0.40 BSC	0.20±0.03	1.60 REF.

### NOTES:

1. ALL DIMENSIONS ARE IN mm. ANGLES IN DEGREES.
2. COPLANARITY SHALL NOT EXCEED 0.08mm.
3. WARPAGE SHALL NOT EXCEED 0.10mm.
4. PACKAGE LENGTH/PACKAGE WIDTH ARE CONSIDERED AS SPECIAL CHARACTERISTIC(S).
5. "N" IS THE TOTAL NUMBER OF LEADS.
6. NUMBER OF LEADS SHOWN ARE FOR REFERENCE ONLY.
7.  MARKING IS FOR PACKAGE ORIENTATION REFERENCE ONLY.
8. ONLY 8L PACKAGE COMPLIES TO JEDEC M0252.
9. ALL DIMENSIONS APPLY TO BOTH LEADED (-) AND PbFREE (+) PACKAGE CODES.

-DRAWING NOT TO SCALE-

			
TITLE: PACKAGE OUTLINE, 6, 8, 10L uDFN, 2x2x0.80 mm			
APPROVAL	DOCUMENT CONTROL NO. 21-0164	REV. B	2/2

Maxim cannot assume responsibility for use of any circuitry other than circuitry entirely embodied in a Maxim product. No circuit patent licenses are implied. Maxim reserves the right to change the circuitry and specifications without notice at any time.

Maxim Integrated Products, 120 San Gabriel Drive, Sunnyvale, CA 94086 408-737-7600 \_\_\_\_\_ 9

# Mouser Electronics

Authorized Distributor

Click to View Pricing, Inventory, Delivery & Lifecycle Information:

[Maxim Integrated:](#)

[MAX9892ELT+T](#) [MAX9892ERT+T](#)