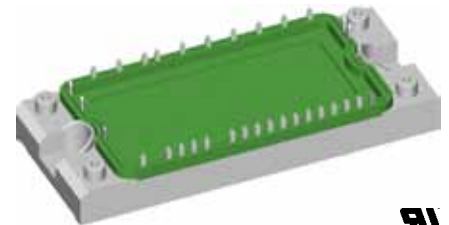
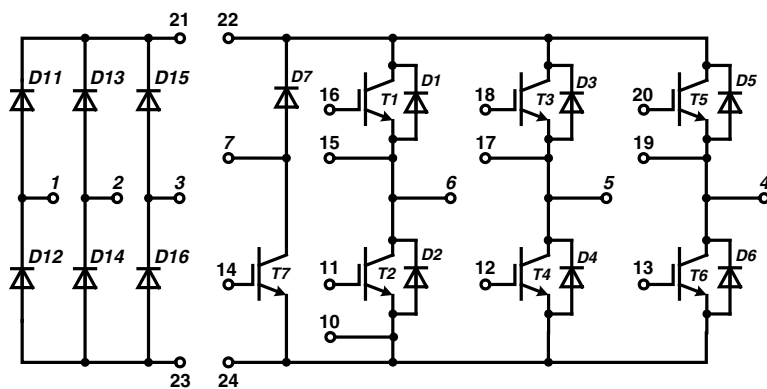


Converter - Brake - Inverter Module XPT IGBT

Three Phase Rectifier	Brake Chopper	Three Phase Inverter
$V_{RRM} = 1600\text{ V}$	$V_{CES} = 1200\text{ V}$	$V_{CES} = 1200\text{ V}$
$I_{DAVM} = 105\text{ A}$	$I_{C25} = 28\text{ A}$	$I_{C25} = 60\text{ A}$
$I_{FSM} = 320\text{ A}$	$V_{CE(sat)} = 1.8\text{ V}$	$V_{CE(sat)} = 1.8\text{ V}$

Part name (Marking on product)

MIXA40WB1200TED



E 72873

Pin configuration see outlines.

Features:

- Easy paralleling due to the positive temperature coefficient of the on-state voltage
- Rugged XPT design (Xtreme light Punch Through) results in:
 - short circuit rated for 10 μsec .
 - very low gate charge
 - square RBSOA @ $3x I_C$
 - low EMI
- Thin wafer technology combined with the XPT design results in a competitive low $V_{CE(sat)}$
- SONIC™ diode
 - fast and soft reverse recovery
 - low operating forward voltage

Application:

- AC motor drives
- Solar inverter
- Medical equipment
- Uninterruptible power supply
- Air-conditioning systems
- Welding equipment
- Switched-mode and resonant-mode power supplies

Package:

- "E2-Pack" standard outline
- Insulated copper base plate
- Soldering pins for PCB mounting
- Temperature sense included

Output Inverter T1 - T6

Symbol	Definitions	Conditions	Ratings				
			min.	typ.	max.	Unit	
V_{CES}	collector emitter voltage		$T_{VJ} = 25^{\circ}\text{C}$		1200	V	
V_{GES}	max. DC gate voltage	continuous			± 20	V	
V_{GEM}	max. transient collector gate voltage	transient			± 30	V	
I_{C25}	collector current		$T_C = 25^{\circ}\text{C}$		60	A	
I_{C80}			$T_C = 80^{\circ}\text{C}$		40	A	
P_{tot}	total power dissipation		$T_C = 25^{\circ}\text{C}$		195	W	
$V_{CE(sat)}$	collector emitter saturation voltage	$I_C = 35\text{ A}; V_{GE} = 15\text{ V}$	$T_{VJ} = 25^{\circ}\text{C}$ $T_{VJ} = 125^{\circ}\text{C}$	1.8 2.1	2.1	V V	
$V_{GE(th)}$	gate emitter threshold voltage	$I_C = 1.5\text{ mA}; V_{GE} = V_{CE}$	$T_{VJ} = 25^{\circ}\text{C}$	5.4	6.0	6.5	V
I_{CES}	collector emitter leakage current	$V_{CE} = V_{CES}; V_{GE} = 0\text{ V}$	$T_{VJ} = 25^{\circ}\text{C}$ $T_{VJ} = 125^{\circ}\text{C}$		0.2	2.1	mA mA
I_{GES}	gate emitter leakage current	$V_{GE} = \pm 20\text{ V}$			500	nA	
$Q_{G(on)}$	total gate charge	$V_{CE} = 600\text{ V}; V_{GE} = 15\text{ V}; I_C = 35\text{ A}$			106	nC	
$t_{d(on)}$	turn-on delay time	inductive load $V_{CE} = 600\text{ V}; I_C = 35\text{ A}$ $V_{GE} = \pm 15\text{ V}; R_G = 27\ \Omega$	$T_{VJ} = 125^{\circ}\text{C}$		70	ns	
t_r	current rise time				40	ns	
$t_{d(off)}$	turn-off delay time				250	ns	
t_f	current fall time				100	ns	
E_{on}	turn-on energy per pulse				3.8	mJ	
E_{off}	turn-off energy per pulse				4.1	mJ	
RBSOA	reverse bias safe operating area	$V_{GE} = \pm 15\text{ V}; R_G = 27\ \Omega;$	$T_{VJ} = 125^{\circ}\text{C}$ $V_{CEK} = 1200\text{ V}$		105	A	
SCSOA	short circuit safe operating area		$T_{VJ} = 125^{\circ}\text{C}$		10	μs	
t_{SC}	short circuit duration	$V_{CE} = 900\text{ V}; V_{GE} = \pm 15\text{ V};$ $R_G = 27\ \Omega;$ non-repetitive			140	A	
I_{SC}	short circuit current						
R_{thJC}	thermal resistance junction to case	(per IGBT)			0.64	K/W	

Output Inverter D1 - D6

Symbol	Definitions	Conditions	Ratings			
			min.	typ.	max.	Unit
V_{RRM}	max. repetitive reverse voltage		$T_{VJ} = 25^{\circ}\text{C}$		1200	V
I_{F25}	forward current		$T_C = 25^{\circ}\text{C}$		44	A
I_{F80}			$T_C = 80^{\circ}\text{C}$		29	A
V_F	forward voltage	$I_F = 30\text{ A}; V_{GE} = 0\text{ V}$	$T_{VJ} = 25^{\circ}\text{C}$ $T_{VJ} = 125^{\circ}\text{C}$	1.95 1.95	2.2	V V
Q_{rr}	reverse recovery charge	$V_R = 600\text{ V}$ $di_f/dt = -600\text{ A}/\mu\text{s}$ $I_F = 30\text{ A}; V_{GE} = 0\text{ V}$	$T_{VJ} = 125^{\circ}\text{C}$		3.5	μC
I_{RM}	max. reverse recovery current				30	A
t_{rr}	reverse recovery time				350	ns
E_{rec}	reverse recovery energy				0.9	mJ
R_{thJC}	thermal resistance junction to case	(per diode)			1.2	K/W

 $T_C = 25^{\circ}\text{C}$ unless otherwise stated

Brake T7

Symbol	Definitions	Conditions	Ratings			Unit	
			min.	typ.	max.		
V_{CES}	collector emitter voltage		$T_{VJ} = 25^{\circ}\text{C}$		1200	V	
V_{GES}	max. DC gate voltage	continuous			± 20	V	
V_{GEM}	max. transient collector gate voltage	transient			± 30	V	
I_{C25}	collector current		$T_C = 25^{\circ}\text{C}$		28	A	
I_{C80}			$T_C = 80^{\circ}\text{C}$		20	A	
P_{tot}	total power dissipation		$T_C = 25^{\circ}\text{C}$		100	W	
$V_{CE(sat)}$	collector emitter saturation voltage	$I_C = 16\text{ A}; V_{GE} = 15\text{ V}$	$T_{VJ} = 25^{\circ}\text{C}$ $T_{VJ} = 125^{\circ}\text{C}$	1.8 2.1	2.1	V V	
$V_{GE(th)}$	gate emitter threshold voltage	$I_C = 0.6\text{ mA}; V_{GE} = V_{CE}$	$T_{VJ} = 25^{\circ}\text{C}$	5.4	6.0	6.5	V
I_{CES}	collector emitter leakage current	$V_{CE} = V_{CES}; V_{GE} = 0\text{ V}$	$T_{VJ} = 25^{\circ}\text{C}$ $T_{VJ} = 125^{\circ}\text{C}$		0.1	0.1	mA mA
I_{GES}	gate emitter leakage current	$V_{GE} = \pm 20\text{ V}$			500	nA	
$Q_{G(on)}$	total gate charge	$V_{CE} = 600\text{ V}; V_{GE} = 15\text{ V}; I_C = 15\text{ A}$			48	nC	
$t_{d(on)}$	turn-on delay time	inductive load $V_{CE} = 600\text{ V}; I_C = 15\text{ A}$ $V_{GE} = \pm 15\text{ V}; R_G = 56\ \Omega$	$T_{VJ} = 125^{\circ}\text{C}$		70	ns	
t_r	current rise time				40	ns	
$t_{d(off)}$	turn-off delay time				250	ns	
t_f	current fall time				100	ns	
E_{on}	turn-on energy per pulse				1.6	mJ	
E_{off}	turn-off energy per pulse				1.7	mJ	
RBSOA	reverse bias safe operating area	$V_{GE} = \pm 15\text{ V}; R_G = 56\ \Omega;$	$T_{VJ} = 125^{\circ}\text{C}$ $V_{CEK} = 1200\text{ V}$		45	A	
SCSOA	short circuit safe operating area		$T_{VJ} = 125^{\circ}\text{C}$		10	μs	
t_{SC}	short circuit duration	$V_{CE} = 900\text{ V}; V_{GE} = \pm 15\text{ V};$			60	μs	
I_{SC}	short circuit current	$R_G = 56\ \Omega;$ non-repetitive				A	
R_{thJC}	thermal resistance junction to case	(per IGBT)			1.26	K/W	

Brake Chopper D7

Symbol	Definitions	Conditions	Ratings			Unit
			min.	typ.	max.	
V_{RRM}	max. repetitive reverse voltage		$T_{VJ} = 25^{\circ}\text{C}$		1200	V
I_{F25}	forward current		$T_C = 25^{\circ}\text{C}$		12	A
I_{F80}			$T_C = 80^{\circ}\text{C}$		8	A
V_F	forward voltage	$I_F = 10\text{ A}; V_{GE} = 0\text{ V}$	$T_{VJ} = 25^{\circ}\text{C}$ $T_{VJ} = 125^{\circ}\text{C}$	2.5 2.6	2.9	V V
I_R	reverse current	$V_R = V_{RRM}$	$T_{VJ} = 25^{\circ}\text{C}$ $T_{VJ} = 125^{\circ}\text{C}$	0.5	0.5	mA mA
Q_{rr}	reverse recovery charge	$V_R = 600\text{ V}$ $di_F/dt = 200\text{ A}/\mu\text{s}$ $I_F = 5\text{ A}; V_{GE} = 0\text{ V}$	$T_{VJ} = 125^{\circ}\text{C}$		0.6	μC
I_{RM}	max. reverse recovery current				6	A
t_{rr}	reverse recovery time				350	ns
E_{rec}	reverse recovery energy				0.2	mJ
R_{thJC}	thermal resistance junction to case	(per diode)			3.4	K/W

 $T_C = 25^{\circ}\text{C}$ unless otherwise stated

Input Rectifier Bridge D11 - D16

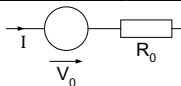
Symbol	Definitions	Conditions	Ratings			Unit
			min.	typ.	max.	
V_{RRM}	max. repetitive reverse voltage				1600	V
I_{FAV}	average forward current	sine 180°			37	A
I_{DAVM}	max. average DC output current	rect.; $d = 1/3$			105	A
I_{FSM}	max. forward surge current	$t = 10$ ms; sine 50 Hz			320	A
					280	A
I^2t	I^2t value for fusing	$t = 10$ ms; sine 50 Hz			510	A ² s
					390	A ² s
P_{tot}	total power dissipation				114	W
V_F	forward voltage	$I_F = 50$ A		1.34	1.7	V
				1.34		V
I_R	reverse current	$V_R = V_{RRM}$			0.02	mA
				0.2		mA
R_{thJC}	thermal resistance junction to case	(per diode)			1.1	K/W

Temperature Sensor NTC

Symbol	Definitions	Conditions	Ratings			Unit
			min.	typ.	max.	
R_{25}	resistance		4.75	5.0	5.25	k Ω
$B_{25/50}$				3375		K

Module

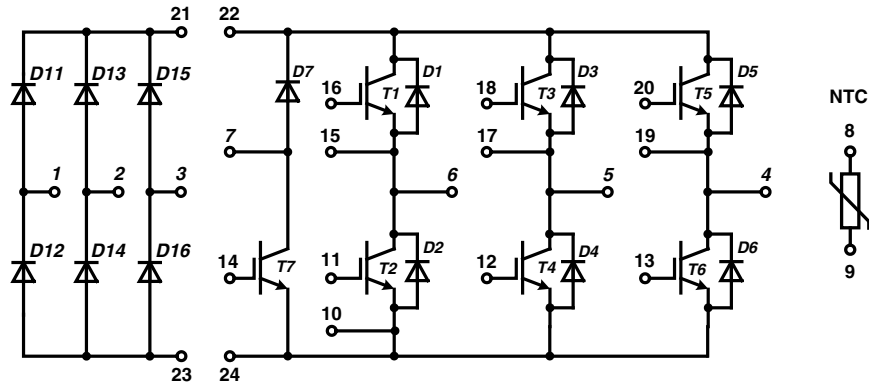
Symbol	Definitions	Conditions	Ratings			Unit
			min.	typ.	max.	
T_{VJ}	operating temperature		-40		125	°C
T_{VJM}	max. virtual junction temperature				150	°C
T_{stg}	storage temperature		-40		125	°C
V_{ISOL}	isolation voltage	$I_{ISOL} \leq 1$ mA; 50/60 Hz			2500	V~
CTI	comparative tracking index				-	
M_d	mounting torque (M5)		3		6	Nm
d_S	creep distance on surface		6			mm
d_A	strike distance through air		6			mm
$R_{pin-chip}$	resistance pin to chip			5		m Ω
R_{thCH}	thermal resistance case to heatsink	with heatsink compound		0.02		K/W
Weight				180		g

Equivalent Circuits for Simulation


Symbol	Definitions	Conditions	Ratings			Unit
			min.	typ.	max.	
V_0	rectifier diode	D8 - D13			0.88	V
R_0					9	m Ω
V_0	IGBT	T1 - T6			1.1	V
R_0					40	m Ω
V_0	free wheeling diode	D1 - D6			1.2	V
R_0					27	m Ω
V_0	IGBT	T7			1.1	V
R_0					86	m Ω
V_0	free wheeling diode	D7			1.15	V
R_0					170	m Ω

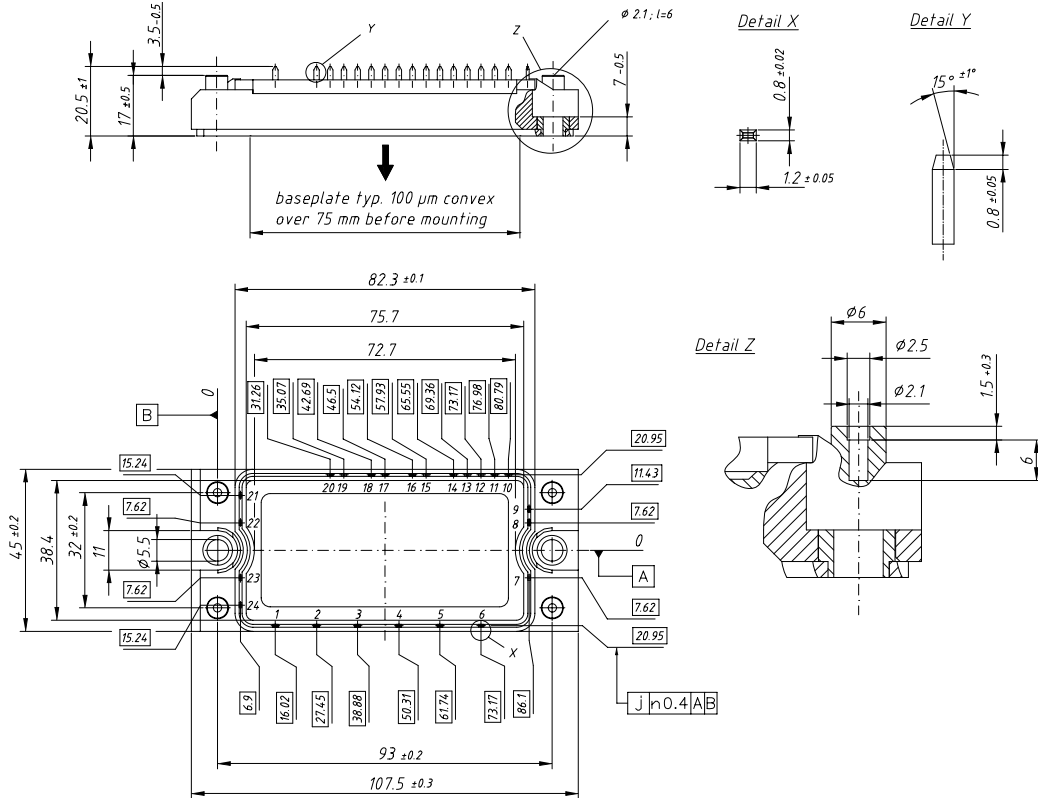
 $T_C = 25^\circ\text{C}$ unless otherwise stated

Circuit Diagram

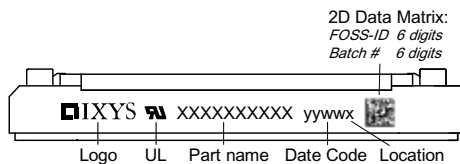


Outline Drawing

Dimensions in mm (1 mm = 0.0394")



Product Marking



2D Data Matrix:
FOSS-ID 6 digits
Batch # 6 digits

Part number

- M = Module
- I = IGBT
- X = XPT
- A = Standard
- 40 = Current Rating [A]
- WB = 6-Pack + 3~ Rectifier Bridge & Brake Unit
- 1200 = Reverse Voltage [V]
- T = NTC
- ED = E2-Pack

Ordering	Part Name	Marking on Product	Delivering Mode	Base Qty	Ordering Code
Standard	MIXA40WB1200 TED	MIXA40WB1200TED	Box	6	507497

Inverter T1 - T6

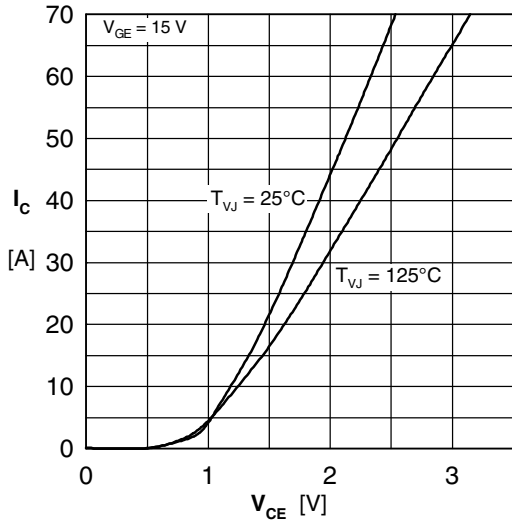


Fig. 1 Typ. output characteristics

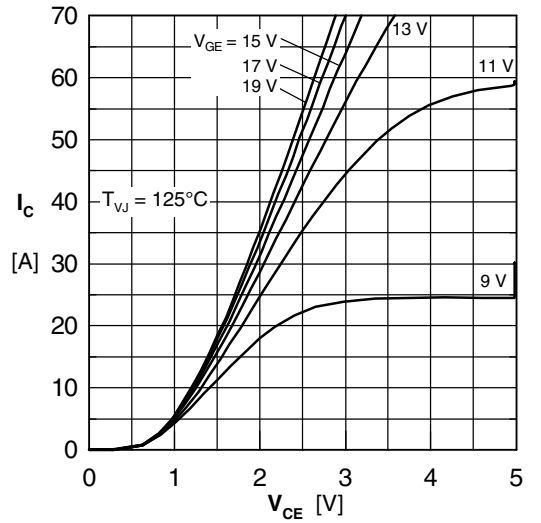


Fig. 2 Typ. output characteristics

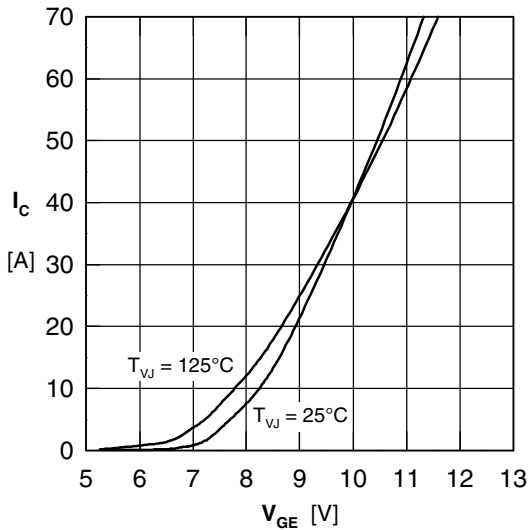


Fig. 3 Typ. transfer characteristics

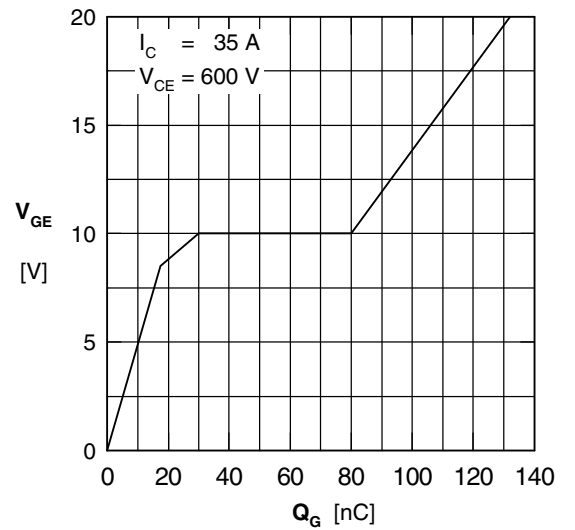


Fig. 4 Typ. turn-on gate charge

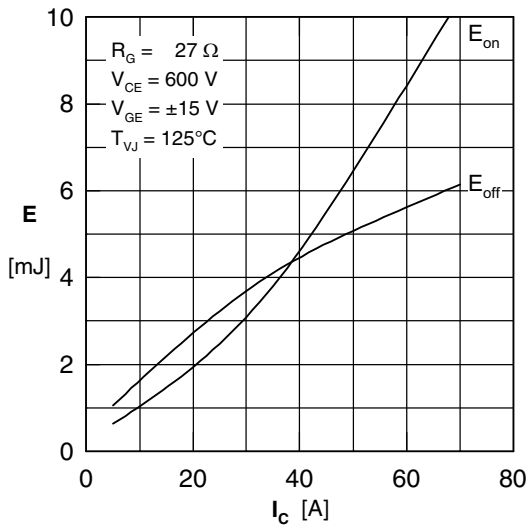


Fig. 5 Typ. switching energy vs. collector current

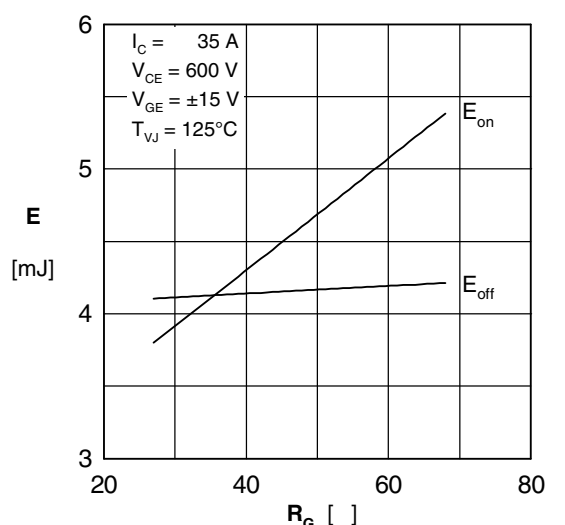


Fig. 6 Typ. switching energy vs. gate resistance

Inverter D1 - D6

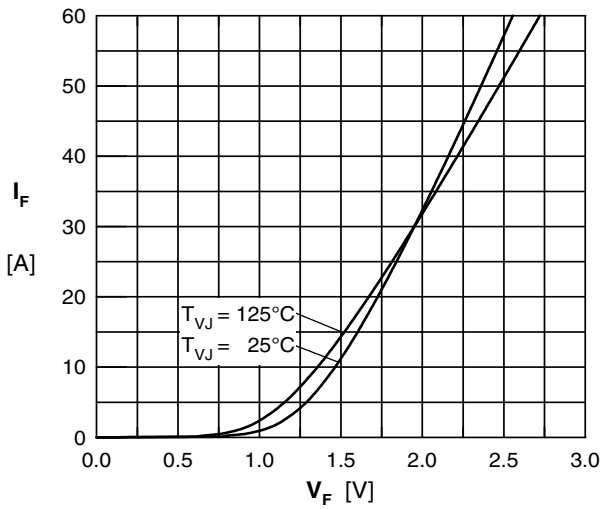


Fig. 7 Typ. Forward current versus V_F

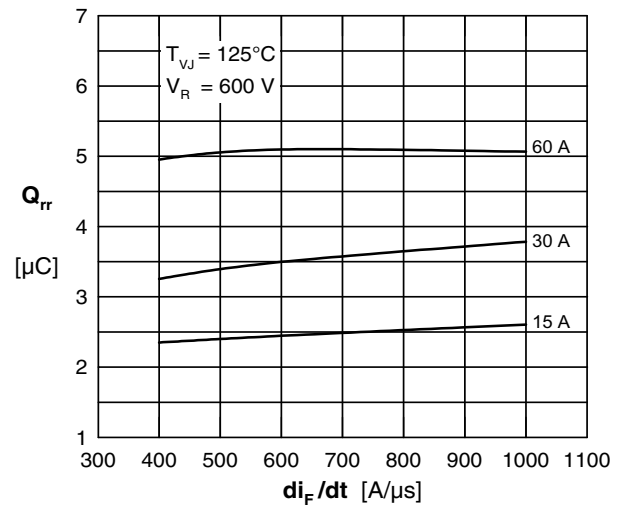


Fig. 8 Typ. reverse recov. charge Q_{rr} vs. di/dt

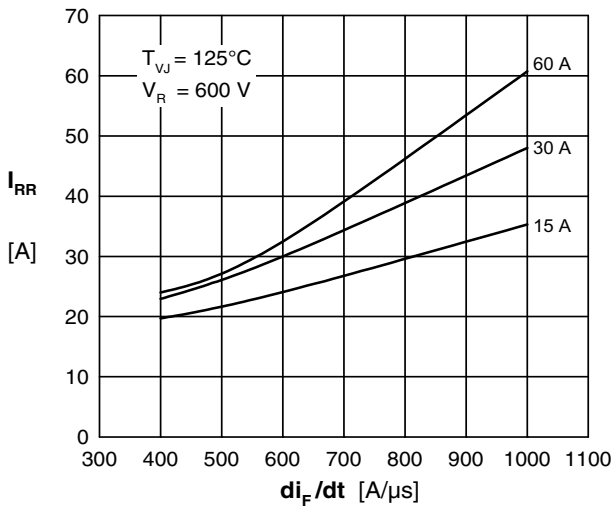


Fig. 9 Typ. peak reverse current I_{RM} vs. di/dt

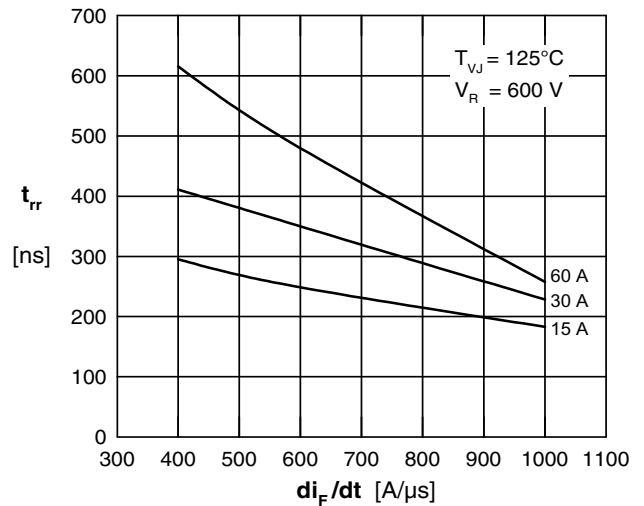


Fig. 10 Typ. recovery time t_{rr} versus di/dt

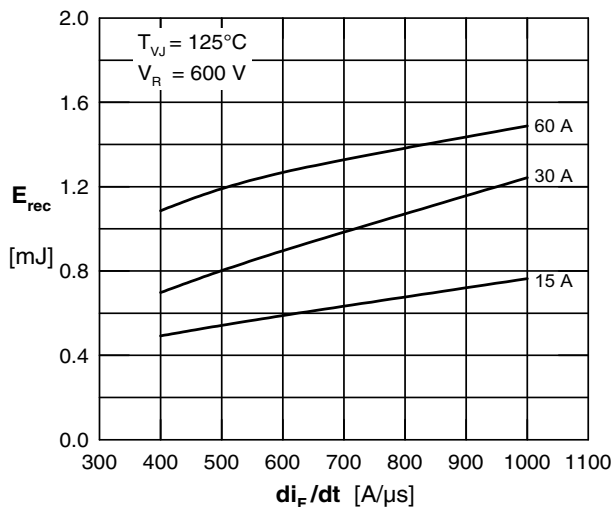


Fig. 5 Typ. recovery energy E_{rec} versus di/dt

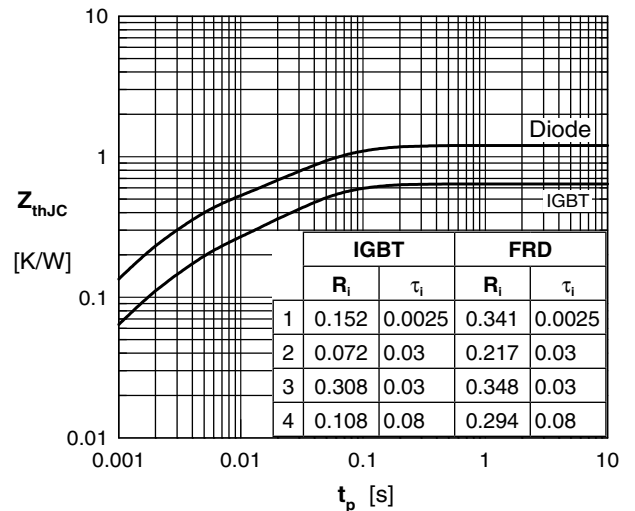


Fig. 12 Typ. transient thermal impedance

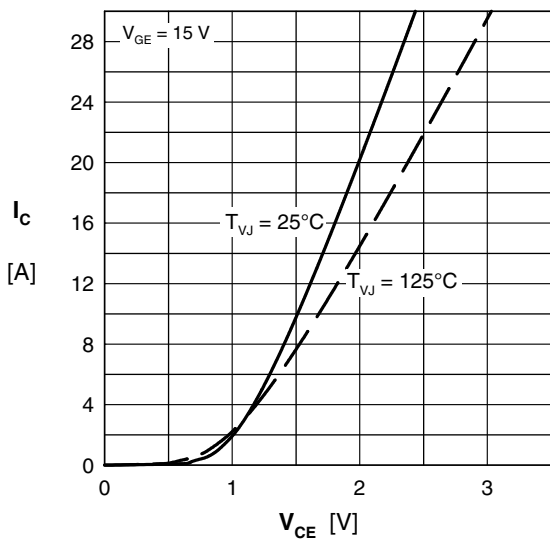
Brake T7 & D7


Fig. 13 Typ. output characteristics

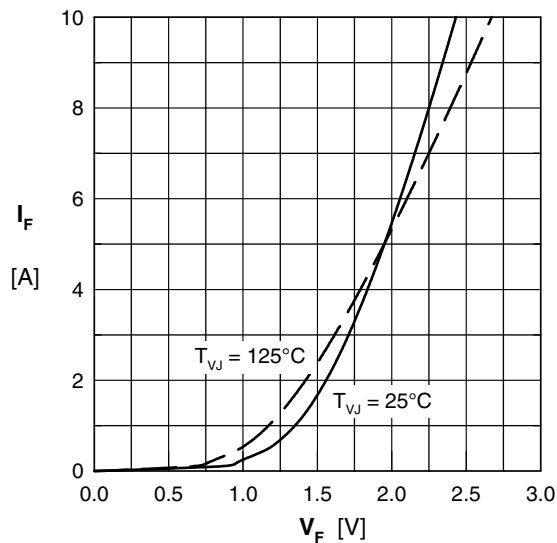


Fig. 14 Typ. forward characteristics

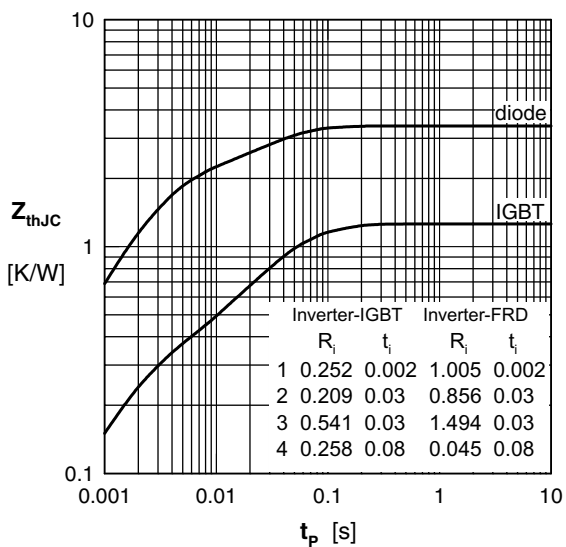


Fig. 15 Typ. transient thermal impedance

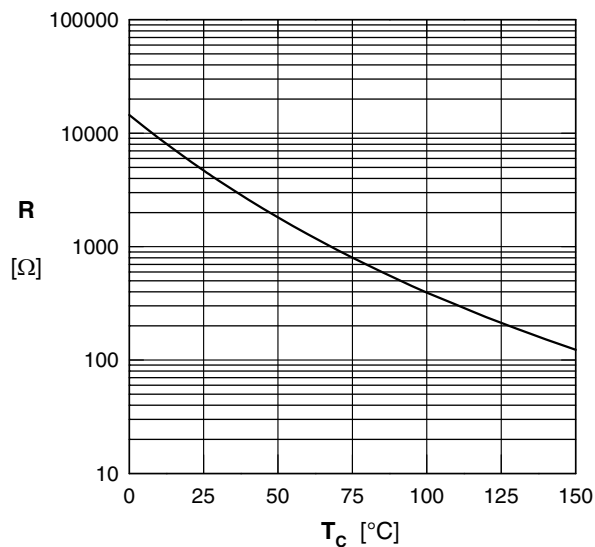


Fig. 16 Typ. NTC resistance vs. temperature

Mouser Electronics

Authorized Distributor

Click to View Pricing, Inventory, Delivery & Lifecycle Information:

[IXYS:](#)

[MIXA40WB1200TED](#)