

HiPerFRED

V_{RRM}	=	600V
I_{DAV}	=	22A
t_{rr}	=	30ns

High Performance Fast Recovery Diode
 Low Loss and Soft Recovery
 1~ Rectifier Bridge

Part number

FBE22-06N1

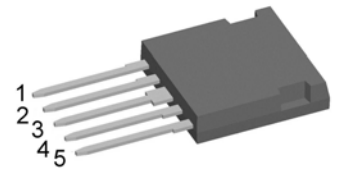

Backside: isolated

 E72873

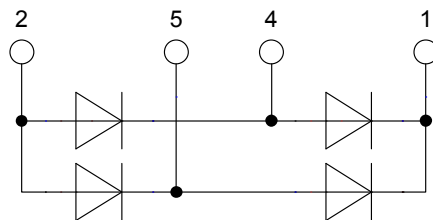
**Features / Advantages:**

- Planar passivated chips
- Very low leakage current
- Very short recovery time
- Improved thermal behaviour
- Very low I_{rm} -values
- Very soft recovery behaviour
- Avalanche voltage rated for reliable operation
- Soft reverse recovery for low EMI/RFI
- Low I_{rm} reduces:
 - Power dissipation within the diode
 - Turn-on loss in the commutating switch

Applications:

- Rectifiers in switch mode power supplies (SMPS)

Package: i4-Pac

- Isolation Voltage: 3000V~
- Industry convenient outline
- RoHS compliant
- Epoxy meets UL 94V-0
- Soldering pins for PCB mounting
- Backside: DCB ceramic
- Reduced weight
- Advanced power cycling

Fast Diode				Ratings				
Symbol	Definition	Conditions		min.	typ.	max.	Unit	
V_{RSM}	max. non-repetitive reverse blocking voltage					600	V	
V_{RRM}	max. repetitive reverse blocking voltage					600	V	
I_R	reverse current, drain current	$V_R = 600\text{ V}$		$T_{VJ} = 25^\circ\text{C}$		60	μA	
		$V_R = 600\text{ V}$		$T_{VJ} = 150^\circ\text{C}$		0.25	mA	
V_F	forward voltage drop	$I_F = 11\text{ A}$		$T_{VJ} = 25^\circ\text{C}$		2.13	V	
						$I_F = 22\text{ A}$		2.35
		$I_F = 11\text{ A}$		$T_{VJ} = 150^\circ\text{C}$		1.44	V	
						$I_F = 22\text{ A}$		1.71
I_{DAV}	bridge output current	$T_C = 115^\circ\text{C}$	rectangular	$d = 0.5$	$T_{VJ} = 175^\circ\text{C}$		22	A
V_{FO}	threshold voltage			$T_{VJ} = 175^\circ\text{C}$		1.04	V	
r_F	slope resistance							24
R_{thJC}	thermal resistance junction to case					3	K/W	
R_{thCH}	thermal resistance case to heatsink				0.20		K/W	
P_{tot}	total power dissipation			$T_C = 25^\circ\text{C}$		50	W	
I_{FSM}	max. forward surge current	$t = 10\text{ ms}; (50\text{ Hz}), \text{ sine}; V_R = 0\text{ V}$		$T_{VJ} = 45^\circ\text{C}$		50	A	
C_J	junction capacitance	$V_R = 400\text{ V}$ $f = 1\text{ MHz}$		$T_{VJ} = 25^\circ\text{C}$		6	pF	
I_{RM}	max. reverse recovery current			$T_{VJ} = 25^\circ\text{C}$		3.5	A	
				$T_{VJ} = 100^\circ\text{C}$		6	A	
t_{rr}	reverse recovery time		$-di_F/dt = 200\text{ A}/\mu\text{s}$	$T_{VJ} = 25^\circ\text{C}$		30	ns	
				$T_{VJ} = 100^\circ\text{C}$		90	ns	

Package i4-Pac		Ratings				
Symbol	Definition	Conditions	min.	typ.	max.	Unit
I_{RMS}	RMS current	per terminal			35	A
T_{stg}	storage temperature		-55		150	°C
T_{VJ}	virtual junction temperature		-55		175	°C
Weight				9		g
F_C	mounting force with clip		20		120	N
$d_{Spp/App}$	creepage distance on surface striking distance through air	terminal to terminal	1.7			mm
$d_{Spb/Apb}$		terminal to backside	5.1			mm
V_{ISOL}	isolation voltage	t = 1 second	3000			V
		t = 1 minute	2500			V

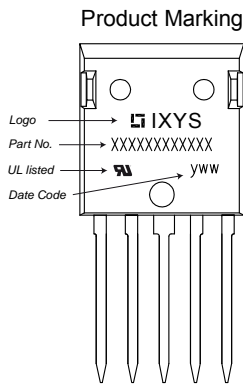

Ordering	Part Number	Marking on Product	Delivery Mode	Quantity	Code No.
Standard	FBE22-06N1	FBE22-06N1	Tube	25	484954

Equivalent Circuits for Simulation

* on die level

$T_{VJ} = 175\text{ °C}$



Fast Diode

$V_{0\ max}$	threshold voltage	1.04	V
$R_{0\ max}$	slope resistance *	21	mΩ

Outlines i4-Pac

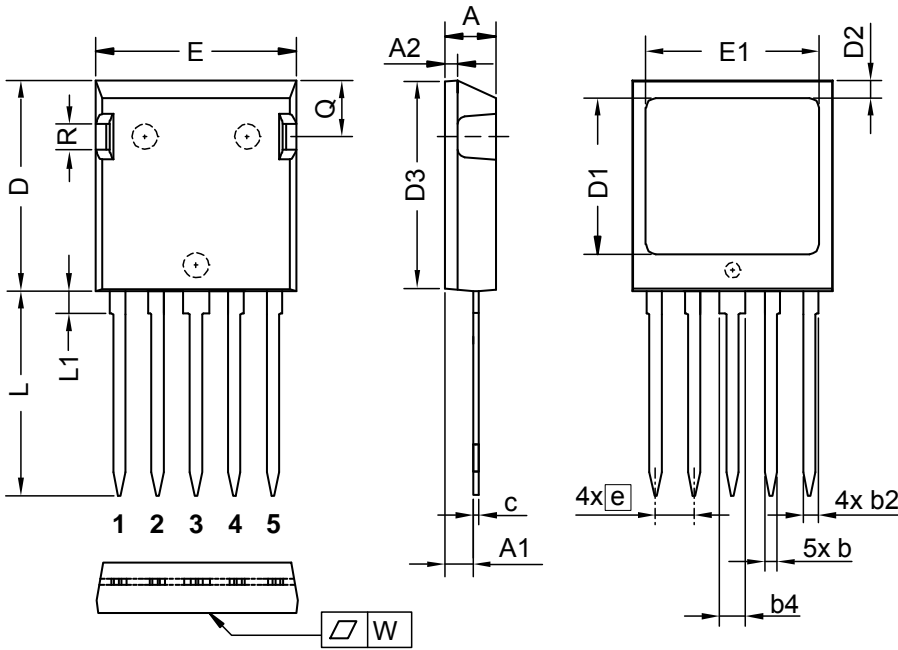

Dim.	Millimeter		Inches	
	min	max	min	max
A	4.83	5.21	0.190	0.205
A1	2.59	3.00	0.102	0.118
A2	1.17	2.16	0.046	0.085
b	1.14	1.40	0.045	0.055
b2	1.47	1.73	0.058	0.068
b4	2.54	2.79	0.100	0.110
c	0.51	0.74	0.020	0.029
D	20.80	21.34	0.819	0.840
D1	14.99	15.75	0.590	0.620
D2	1.65	2.03	0.065	0.080
D3	20.30	20.70	0.799	0.815
E	19.56	20.29	0.770	0.799
E1	16.76	17.53	0.660	0.690
e	3.81 BSC		0.150 BSC	
L	19.81	21.34	0.780	0.840
L1	2.11	2.59	0.083	0.102
Q	5.33	6.20	0.210	0.244
R	2.54	4.57	0.100	0.180
W	-	0.10	-	0.004

Die konvexe Form des Substrates ist typ. < 0.05 mm über der Kunststoffoberfläche der Bauteilunterseite
 The convexbow of substrate is typ. < 0.05 mm over plastic surface level of device bottom side

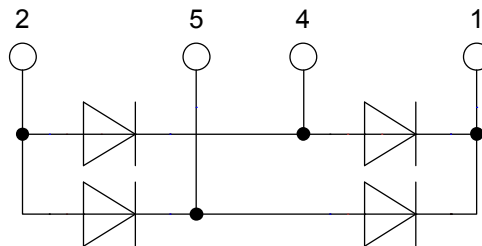

Fast Diode

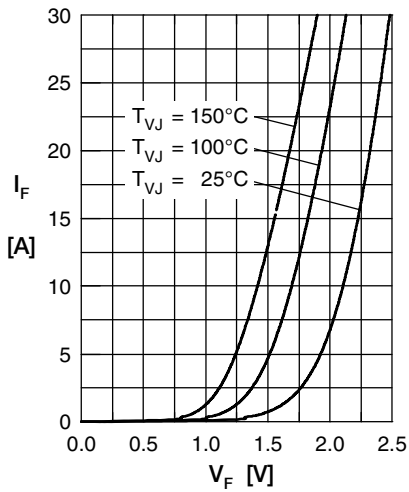

Fig. 1 Forward current I_F versus V_F

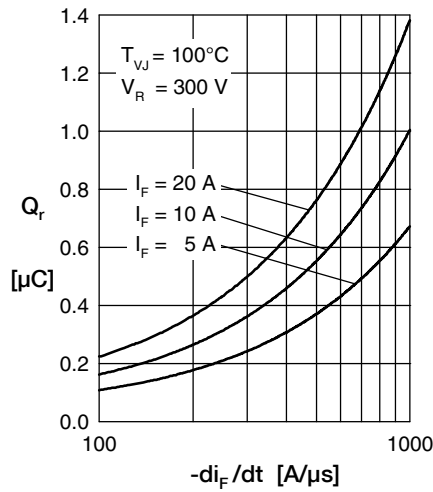

Fig. 2 Typ. reverse recov. charge Q_r versus $-di_F/dt$

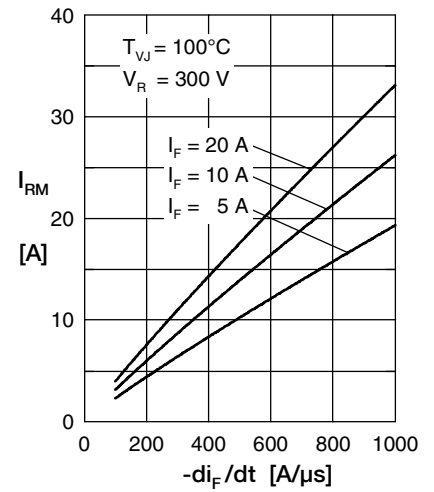

Fig. 3 Typ. peak reverse current I_{RM} versus $-di_F/dt$

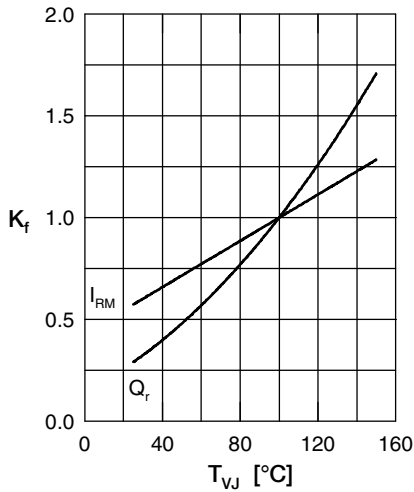

Fig. 4 Dynamic parameters Q_r , I_{RM} versus T_{VJ}

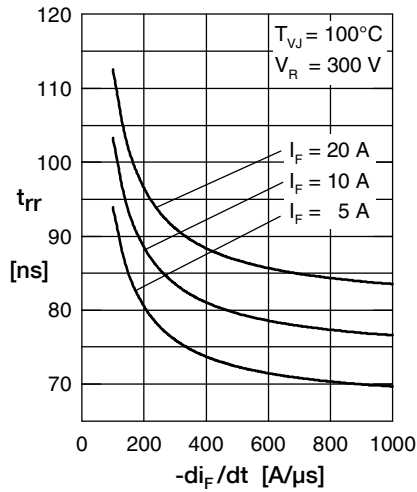

Fig. 5 Typ. recovery time t_{tr} versus $-di_F/dt$

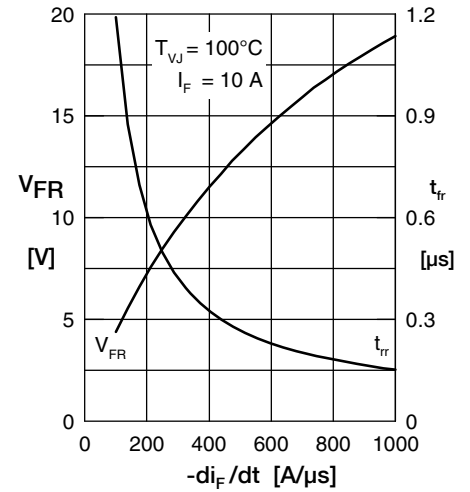

Fig. 6 Typ. peak forward voltage V_{FR} and t_{tr} versus di_F/dt

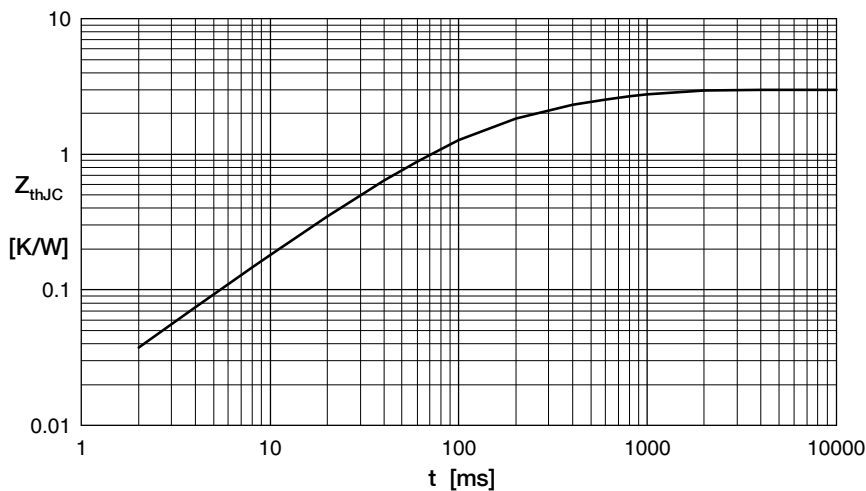

Fig. 7 Transient thermal impedance junction to case

Constants for Z_{thJC} calculation:

i	R_{thi} [K/W]	t_i [s]
1	1.3590	0.1015
2	0.4651	0.1026
3	0.8473	0.4919
4	0.8473	0.6200

Mouser Electronics

Authorized Distributor

Click to View Pricing, Inventory, Delivery & Lifecycle Information:

[IXYS:](#)

[FBE22-06N1](#)