

High Voltage, High Gain BiMOSFET™

IXBK64N250 IXBX64N250

$V_{CES} = 2500V$
 $I_{C110} = 64A$
 $V_{CE(sat)} \leq 3.0V$

Monolithic Bipolar MOS Transistor

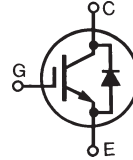

Symbol	Test Conditions	Maximum Ratings	
V_{CES}	$T_J = 25^\circ C$ to $150^\circ C$	2500	V
V_{CGR}	$T_J = 25^\circ C$ to $150^\circ C$, $R_{GE} = 1M\Omega$	2500	V
V_{GES}	Continuous	± 25	V
V_{GEM}	Transient	± 35	V
I_{C25}	$T_C = 25^\circ C$ (Chip Capability)	156	A
I_{LRMS}	Lead Current Limit, RMS	120	A
I_{C100}	$T_C = 110^\circ C$	64	A
I_{CM}	$T_C = 25^\circ C$, 1ms	600	A
SSOA	$V_{GE} = 15V$, $T_{VJ} = 125^\circ C$, $R_G = 1\Omega$	$I_{CM} = 160$	A
(RBSOA)	Clamped Inductive Load	$V_{CE} \leq 0.8 \cdot V_{CES}$	
T_{SC} (SCSOA)	$V_{GE} = 15V$, $T_J = 125^\circ C$, $R_G = 5\Omega$, $V_{CE} = 1250V$, Non-Repetitive	10	μs
P_C	$T_C = 25^\circ C$	735	W
T_J		-55 ... +150	$^\circ C$
T_{JM}		150	$^\circ C$
T_{stg}		-55 ... +150	$^\circ C$
T_L	Maximum Lead Temperature for Soldering	300	$^\circ C$
T_{SOLD}	1.6 mm (0.062 in.) from Case for 10	260	$^\circ C$
M_d	Mounting Torque (TO-264)	1.13/10	Nm/lb.in.
F_c	Mounting Force (PLUS247)	20..120/4.5..27	N/lb.
Weight	TO-264	10	g
	PLUS247	6	g

TO-264 (IXBK)

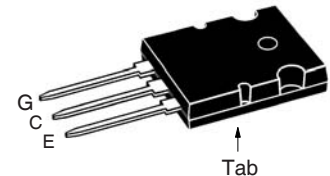

PLUS247™ (IXBX)

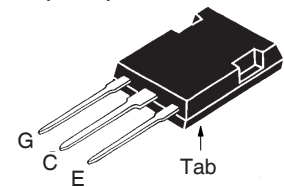

G = Gate C = Collector
 E = Emitter Tab = Collector

Features

- High Blocking Voltage
- Low Switching Losses
- High Current Handling Capability
- Anti-Parallel Diode

Advantages

- High Power Density
- Low Gate Drive Requirement

Applications

- Switch-Mode and Resonant-Mode Power Supplies
- Uninterrupted Power Supplies (UPS)
- Capacitor Discharge Circuits
- Laser Generators

Symbol	Test Conditions ($T_J = 25^\circ C$, Unless Otherwise Specified)	Characteristic Values		
		Min.	Typ.	Max.
BV_{CES}	$I_C = 1mA$, $V_{GE} = 0V$	2500		V
$V_{GE(th)}$	$I_C = 4mA$, $V_{CE} = V_{GE}$	3.0		5.0 V
I_{CES}	$V_{CE} = 0.8 \cdot V_{CES}$, $V_{GE} = 0V$ $T_J = 125^\circ C$			50 μA 6 mA
I_{GES}	$V_{CE} = 0V$, $V_{GE} = \pm 25V$			± 200 nA
$V_{CE(sat)}$	$I_C = I_{C110}$, $V_{GE} = 15V$, Note 1 $T_J = 125^\circ C$		2.5 3.1	V V

Symbol Test Conditions

($T_J = 25^\circ\text{C}$ Unless Otherwise Specified)

Characteristic Values

		Min.	Typ.	Max.	
g_{fs}	$I_C = I_{C110}, V_{CE} = 10V$, Note 1	40	72		S
C_{ies}	$V_{CE} = 25V, V_{GE} = 0V, f = 1\text{MHz}$		8900		pF
C_{oes}			345		pF
C_{res}			118		pF
Q_g	$I_C = I_{C110}, V_{GE} = 15V, V_{CE} = 600V$		400		nC
Q_{ge}			46		nC
Q_{gc}			155		nC
$t_{d(on)}$	Resistive Switching Times, $T_J = 25^\circ\text{C}$ $I_C = 128A, V_{GE} = 15V, tp = 1\mu s$ $V_{CE} = 1250V, R_G = 1\Omega$		49		ns
t_r			318		ns
$t_{d(off)}$			232		ns
t_f			170		ns
$t_{d(on)}$	Resistive Switching Times, $T_J = 125^\circ\text{C}$ $I_C = 128A, V_{GE} = 15V, tp = 1\mu s$ $V_{CE} = 1250V, R_G = 1\Omega$		54		ns
t_r			578		ns
$t_{d(off)}$			222		ns
t_f			175		ns
R_{thJC}				0.17	$^\circ\text{C/W}$
R_{thCS}		0.15			$^\circ\text{C/W}$

Reverse Diode

Symbol Test Conditions

($T_J = 25^\circ\text{C}$ Unless Otherwise Specified)

Characteristic Values

		Min.	Typ.	Max.	
V_F	$I_F = I_{C110}, V_{GE} = 0V$, Note 1			3.0	V
t_{rr}	$I_F = I_{C110}, V_{GE} = 0V, -di_F/dt = 650A/\mu s$ $V_R = 600V, V_{GE} = 0V$		160		ns
I_{RM}			480		A

Note 1: Pulse test, $t \leq 300\mu s$, duty cycle, $d \leq 2\%$.

Additional provisions for lead-to-lead isolation are required at $V_{CE} > 1200V$.

IXYS Reserves the Right to Change Limits, Test Conditions, and Dimensions.

IXYS MOSFETs and IGBTs are covered by one or more of the following U.S. patents:

4,835,592	4,931,844	5,049,961	5,237,481	6,162,665	6,404,065 B1	6,683,344	6,727,585	7,005,734 B2	7,157,338 B2
4,850,072	5,017,508	5,063,307	5,381,025	6,259,123 B1	6,534,343	6,710,405 B2	6,759,692	7,063,975 B2	
4,881,106	5,034,796	5,187,117	5,486,715	6,306,728 B1	6,583,505	6,710,463	6,771,478 B2	7,071,537	

TO-264 Outline

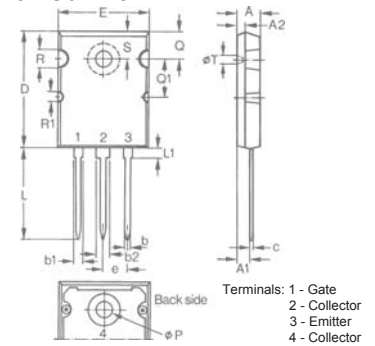

Dim.	Millimeter		Inches	
	Min.	Max.	Min.	Max.
A	4.82	5.13	.190	.202
A1	2.54	2.89	.100	.114
A2	2.00	2.10	.079	.083
b	1.12	1.42	.044	.056
b1	2.39	2.69	.094	.106
b2	2.90	3.09	.114	.122
c	0.53	0.83	.021	.033
D	25.91	26.16	1.020	1.030
E	19.81	19.96	.780	.786
e	5.46 BSC		.215 BSC	
J	0.00	0.25	.000	.010
K	0.00	0.25	.000	.010
L	20.32	20.83	.800	.820
L1	2.29	2.59	.090	.102
P	3.17	3.66	.125	.144
Q	6.07	6.27	.239	.247
Q1	8.38	8.69	.330	.342
R	3.81	4.32	.150	.170
R1	1.78	2.29	.070	.090
S	6.04	6.30	.238	.248
T	1.57	1.83	.062	.072

PLUS247™ Outline

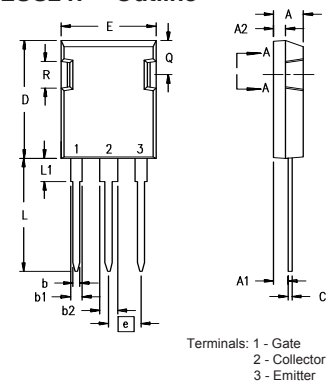

Dim.	Millimeter		Inches	
	Min.	Max.	Min.	Max.
A	4.83	5.21	.190	.205
A1	2.29	2.54	.090	.100
A2	1.91	2.16	.075	.085
b	1.14	1.40	.045	.055
b1	1.91	2.13	.075	.084
b2	2.92	3.12	.115	.123
C	0.61	0.80	.024	.031
D	20.80	21.34	.819	.840
E	15.75	16.13	.620	.635
e	5.45 BSC		.215 BSC	
L	19.81	20.32	.780	.800
L1	3.81	4.32	.150	.170
Q	5.59	6.20	.220	0.244
R	4.32	4.83	.170	.190

Fig. 1. Output Characteristics @ $T_J = 25^\circ\text{C}$

Fig. 2. Output Characteristics @ $T_J = 125^\circ\text{C}$

Fig. 3. Dependence of $V_{CE(sat)}$ on Junction Temperature

Fig. 4. Collector-to-Emitter Voltage vs. Gate-to-Emitter Voltage

Fig. 5. Breakdown & Threshold Voltages vs. Junction Temperature

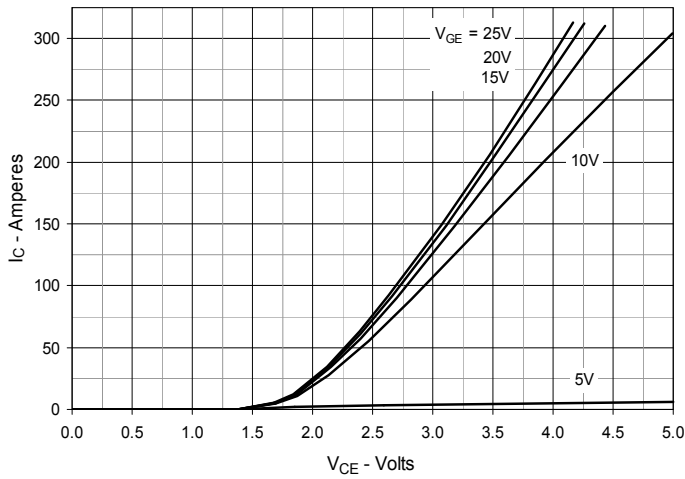
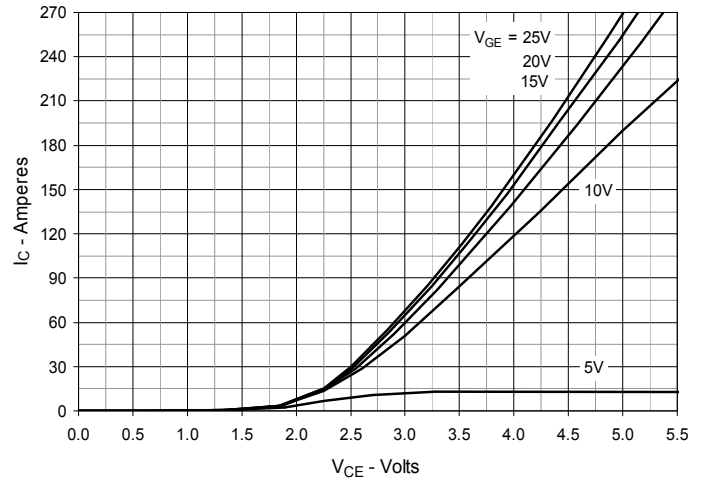
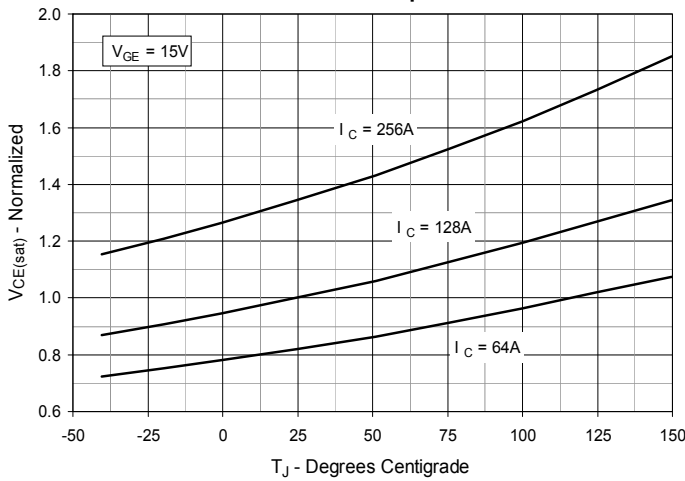
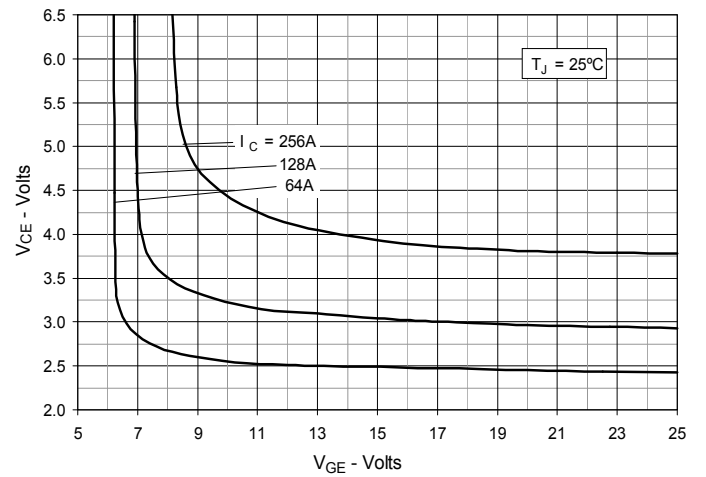
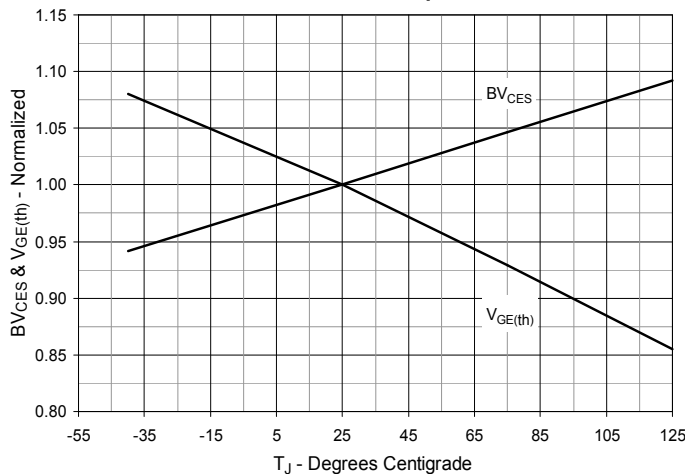
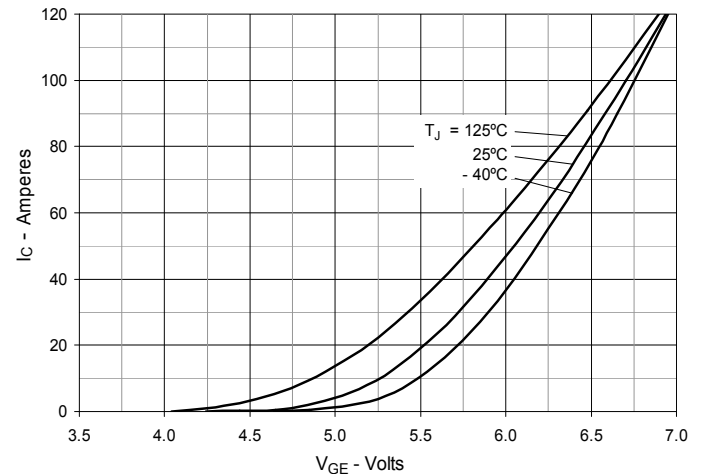
Fig. 6. Input Admittance

Fig. 7. Transconductance

Fig. 8. Forward Voltage Drop of Intrinsic Diode

Fig. 9. Gate Charge

Fig. 10. Capacitance

Fig. 11. Reverse-Bias Safe Operating Area

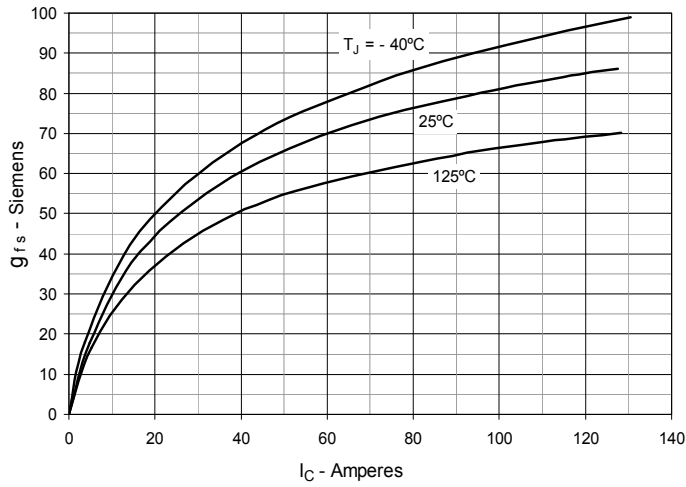
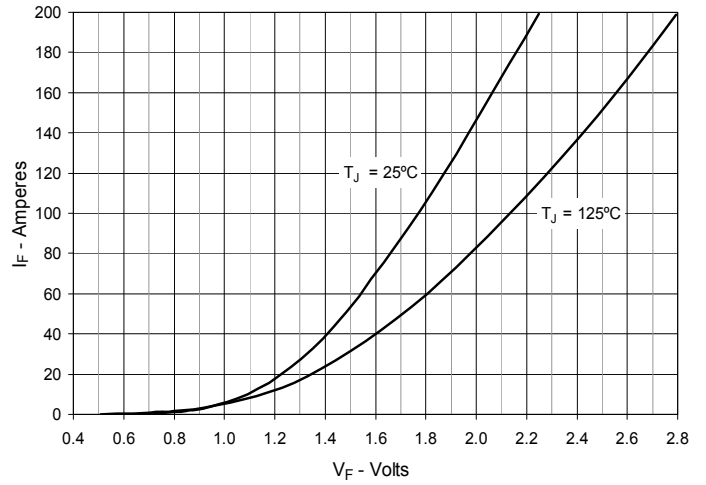
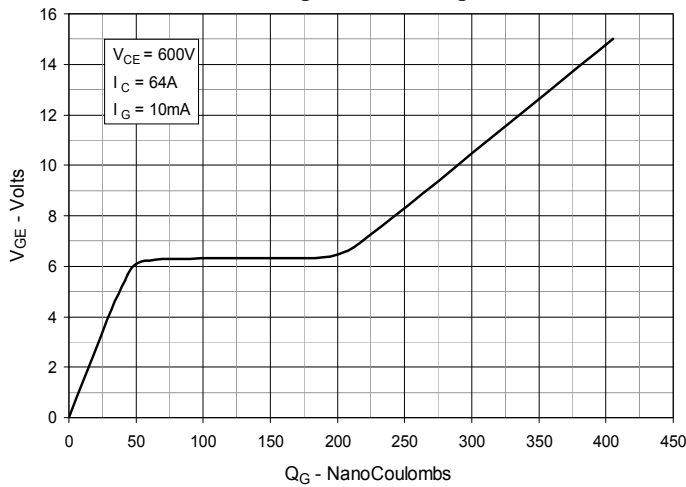
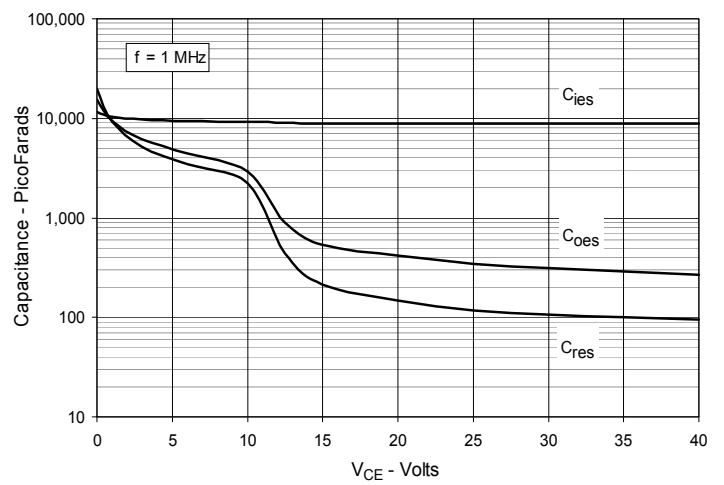
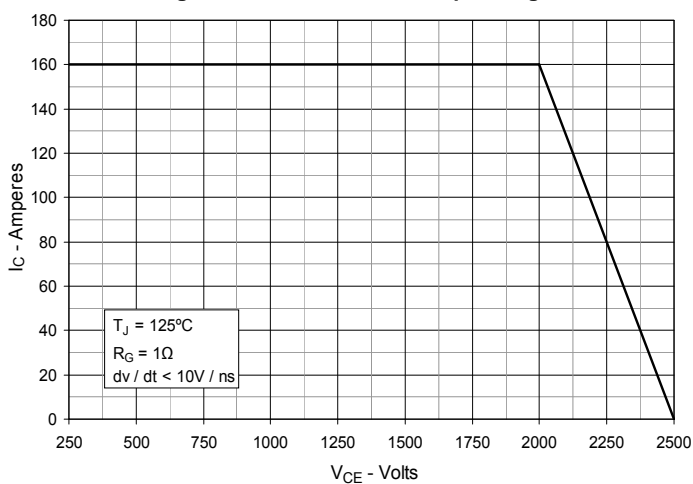
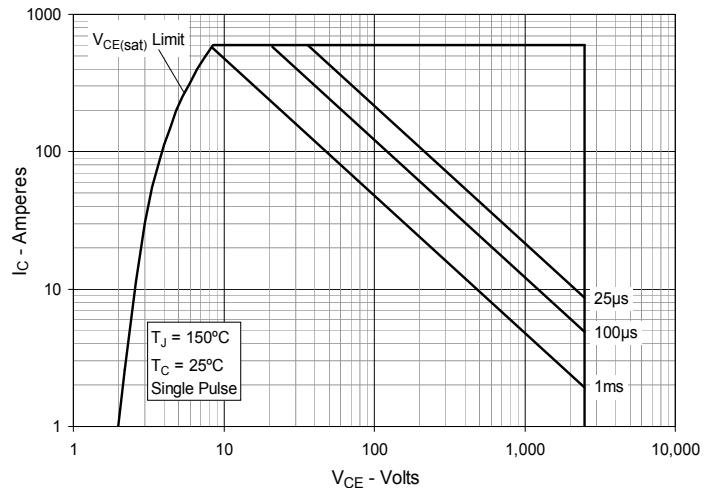
Fig. 12. Forward-Bias Safe Operating Area

Fig. 13. Resistive Turn-on Rise Time vs. Junction Temperature

Fig. 14. Resistive Turn-on Rise Time vs. Drain Current

Fig. 15. Resistive Turn-on Switching Times vs. Gate Resistance

Fig. 16. Resistive Turn-off Switching Times vs. Junction Temperature

Fig. 17. Resistive Turn-off Switching Times vs. Drain Current

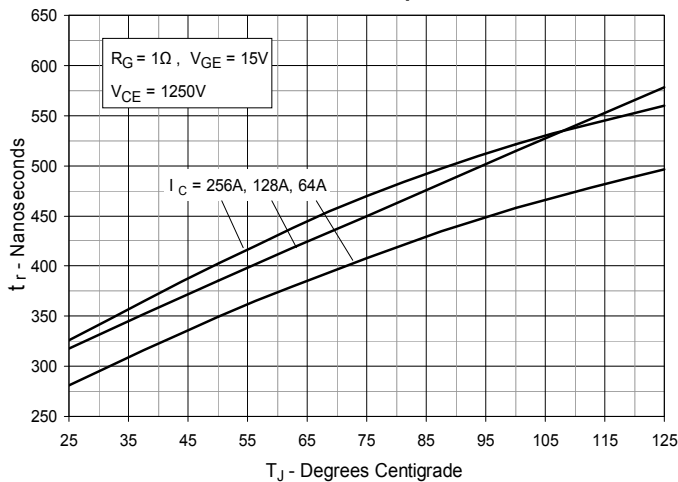
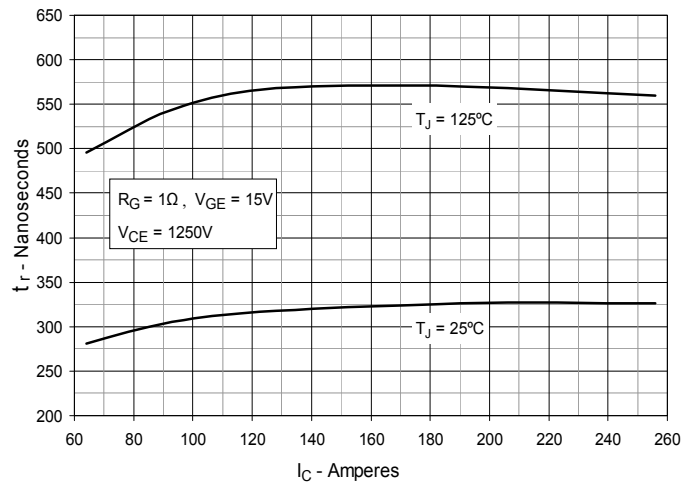
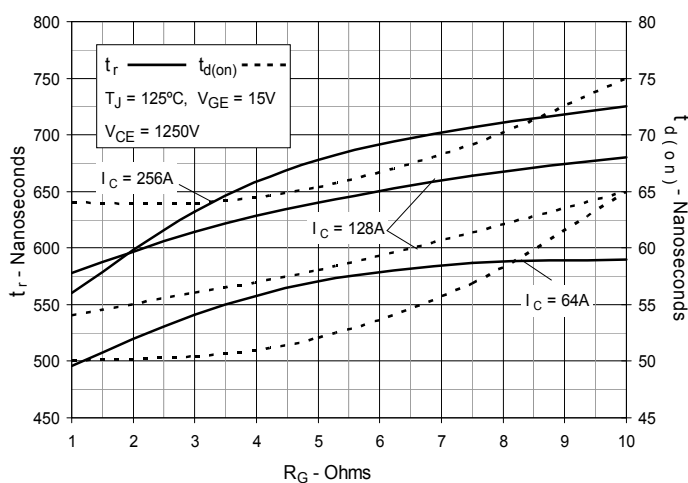
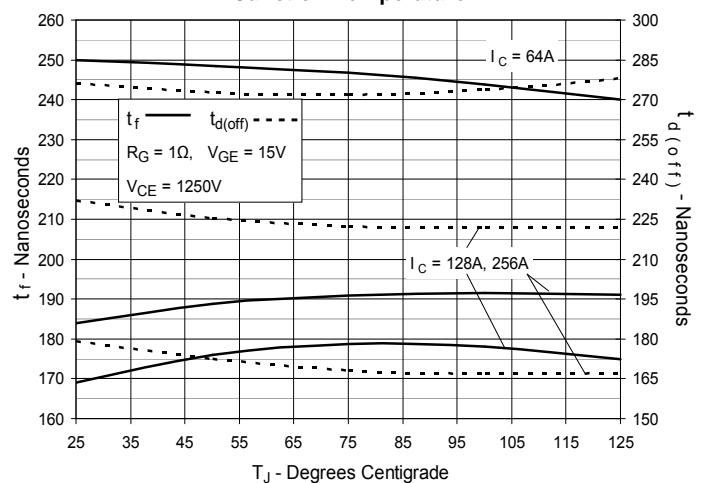
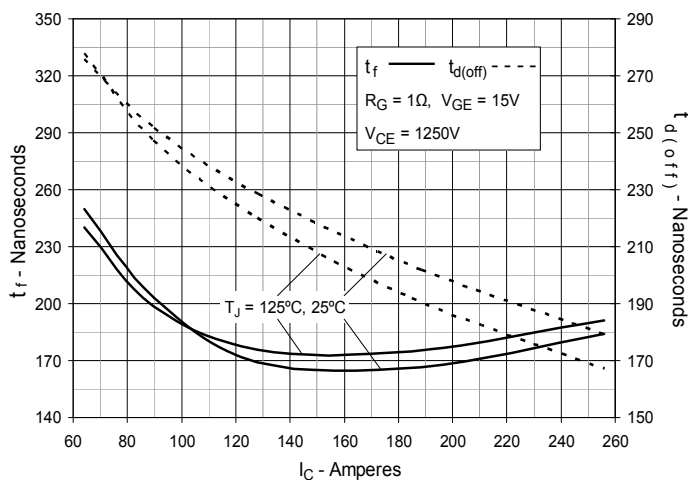
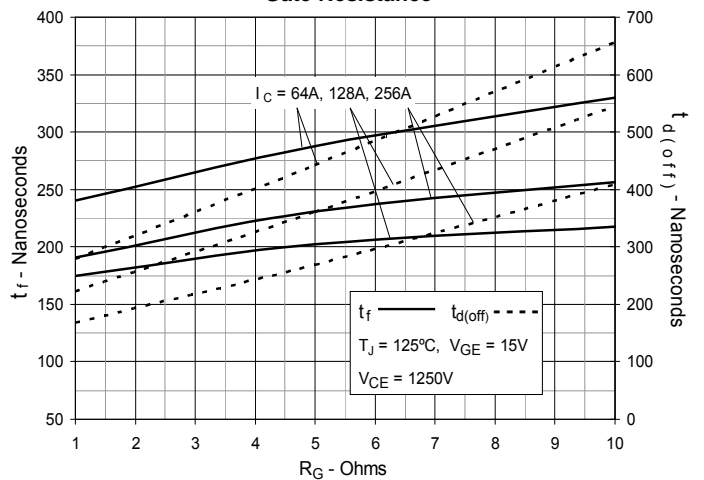
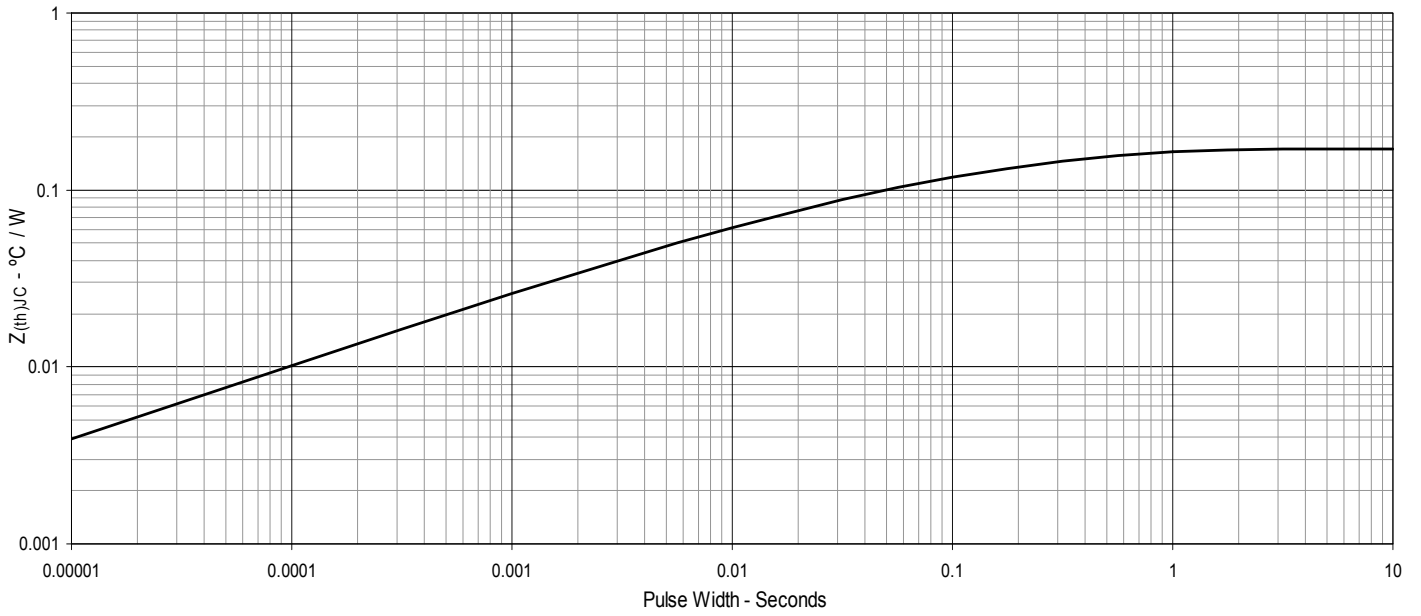
Fig. 18. Resistive Turn-off Switching Times vs. Gate Resistance

Fig. 19. Maximum Transient Thermal Impedance



Mouser Electronics

Authorized Distributor

Click to View Pricing, Inventory, Delivery & Lifecycle Information:

[IXYS:](#)

[IXBK64N250](#)