

Trench Gate Power MOSFET

IXTA50N25T IXTQ50N25T
IXTP50N25T IXTH50N25T

$V_{DSS} = 250V$
 $I_{D25} = 50A$
 $R_{DS(on)} \leq 60m\Omega$

N-Channel Enhancement Mode

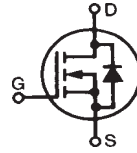

TO-263 AA (IXTA)

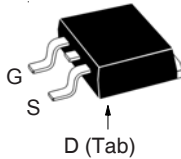

TO-220AB (IXTP)

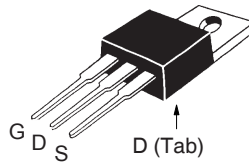

TO-3P (IXTQ)

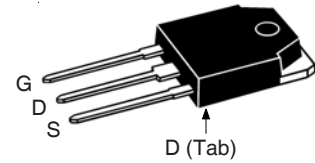

TO-247 (IXTH)

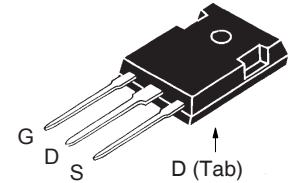

G = Gate D = Drain
S = Source Tab = Drain

Symbol	Test Conditions	Maximum Ratings	
V_{DSS}	$T_J = 25^\circ C$ to $150^\circ C$	250	V
V_{DGR}	$T_J = 25^\circ C$ to $150^\circ C$, $R_{GS} = 1M\Omega$	250	V
V_{GSM}	Transient	± 30	V
I_{D25}	$T_C = 25^\circ C$	50	A
I_{DM}	$T_C = 25^\circ C$, Pulse Width Limited by T_{JM}	130	A
I_A	$T_C = 25^\circ C$	5	A
E_{AS}	$T_C = 25^\circ C$	1.5	J
P_D	$T_C = 25^\circ C$	400	W
T_J		-55 ... +150	$^\circ C$
T_{JM}		150	$^\circ C$
T_{stg}		-55 ... +150	$^\circ C$
T_L	1.6mm (0.062in.) from Case for 10s	300	$^\circ C$
	Plastic Body for 10 s	260	$^\circ C$
M_d	Mounting Torque (TO-220, TO-3P & TO-247)	1.13 / 10	Nmlb.in.
F_C	Mounting Force (TO-263)	10..65 / 2.2..14.6	N/lb.
Weight	TO-263	2.5	g
	TO-220	3.0	g
	TO-3P	5.5	g
	TO-247	6.0	g

Features

- Avalanche Rated
- High Current Handling Capability
- Fast Intrinsic Rectifier
- Low $R_{DS(on)}$

Advantages

- High Power Density
- Easy to Mount
- Space Savings

Applications

- DC-DC Converters
- Battery Chargers
- Switch-Mode and Resonant-Mode Power Supplies
- DC Choppers
- AC and DC Motor Drives
- Uninterrupted Power Supplies
- High Speed Power Switching Applications

Symbol	Test Conditions ($T_J = 25^\circ C$ Unless Otherwise Specified)	Characteristic Values		
		Min.	Typ.	Max.
BV_{DSS}	$V_{GS} = 0V$, $I_D = 1mA$	250		V
$V_{GS(th)}$	$V_{DS} = V_{GS}$, $I_D = 1mA$	3.0		5.0 V
I_{GSS}	$V_{GS} = \pm 20V$, $V_{DS} = 0V$			± 100 nA
I_{DSS}	$V_{DS} = V_{DSS}$, $V_{GS} = 0V$ $T_J = 125^\circ C$			1 μA
				150 μA
$R_{DS(on)}$	$V_{GS} = 10V$, $I_D = 0.5 \cdot I_{D25}$, Note 1			60 m Ω

Symbol	Test Conditions ($T_J = 25^\circ\text{C}$ Unless Otherwise Specified)	Characteristic Values		
		Min.	Typ.	Max.
g_{fs}	$V_{DS} = 10\text{V}, I_D = 0.5 \cdot I_{D25}$, Note 1	35	58	S
C_{iss}	$V_{GS} = 0\text{V}, V_{DS} = 25\text{V}, f = 1\text{MHz}$		4000	pF
C_{oss}			410	pF
C_{rss}			60	pF
$t_{d(on)}$	Resistive Switching Times $V_{GS} = 15\text{V}, V_{DS} = 0.5 \cdot V_{DSS}, I_D = 0.5 \cdot I_{D25}$ $R_G = 3.3\Omega$ (External)		14	ns
t_r			25	ns
$t_{d(off)}$			47	ns
t_f			25	ns
$Q_{g(on)}$	$V_{GS} = 10\text{V}, V_{DS} = 0.5 \cdot V_{DSS}, I_D = 0.5 \cdot I_{D25}$		78	nC
Q_{gs}			19	nC
Q_{gd}			22	nC
R_{thJC}	(TO-220) (TO-3P & TO-247)		0.31	$^\circ\text{C/W}$
R_{thCH}			0.50	$^\circ\text{C/W}$
			0.25	$^\circ\text{C/W}$

Source-Drain Diode

Symbol	Test Conditions ($T_J = 25^\circ\text{C}$ Unless Otherwise Specified)	Characteristic Values		
		Min.	Typ.	Max.
I_S	$V_{GS} = 0\text{V}$			50 A
I_{SM}	Repetitive, Pulse Width Limited by T_{JM}			200 A
V_{SD}	$I_F = I_S, V_{GS} = 0\text{V}$, Note 1			1.5 V
t_{rr}	$I_F = 25\text{A}, -di/dt = 250\text{A}/\mu\text{s}$ $V_R = 100\text{V}, V_{GS} = 0\text{V}$		166	ns
I_{RM}			23	A
Q_{RM}			1.9	μC

Note: 1. Pulse test, $t \leq 300\mu\text{s}$; duty cycle, $d \leq 2\%$.

IXYS Reserves the Right to Change Limits, Test Conditions, and Dimensions.

TO-263 (IXTA) Outline

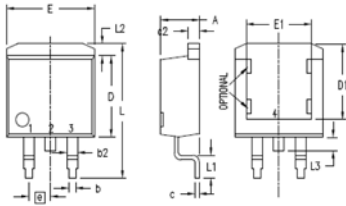

Terminals: 1 - Gate
2 - Drain
3 - Source

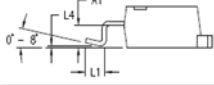

SYM	INCHES		MILLIMETERS	
	MIN	MAX	MIN	MAX
A	.160	.190	4.06	4.83
A1	.080	.110	2.03	2.79
b	.020	.039	0.51	0.99
b2	.045	.055	1.14	1.40
c	.016	.029	0.40	0.74
c2	.045	.055	1.14	1.40
D	.340	.380	8.64	9.65
D1	.315	.350	8.00	8.89
E	.380	.410	9.65	10.41
E1	.245	.320	6.22	8.13
e	.100 BSC		2.54 BSC	
L	.575	.625	14.61	15.88
L1	.090	.110	2.29	2.79
L2	.040	.055	1.02	1.40
L3	.050	.070	1.27	1.78
L4	0	.005	0	0.13

TO-220 (IXTP) Outline

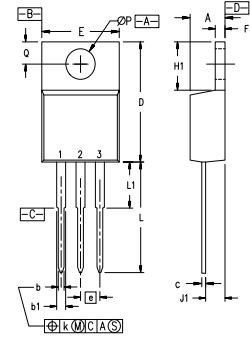

Pins: 1 - Gate 2 - Drain
3 - Source

SYM	INCHES		MILLIMETERS	
	MIN	MAX	MIN	MAX
A	.170	.190	4.32	4.83
b	.025	.040	0.64	1.02
b1	.045	.065	1.15	1.65
c	.014	.022	0.35	0.56
D	.580	.630	14.73	16.00
E	.390	.420	9.91	10.66
e	.100 BSC		2.54 BSC	
F	.045	.055	1.14	1.40
H1	.230	.270	5.85	6.85
J1	.090	.110	2.29	2.79
k	0	.015	0	0.38
L	.500	.550	12.70	13.97
L1	.110	.230	2.79	5.84
ØP	.139	.161	3.53	4.08
Q	.100	.125	2.54	3.18

TO-247 (IXTH) Outline

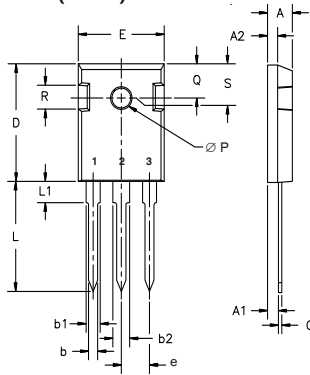

Terminals: 1 - Gate 2 - Drain
3 - Source

Dim.	Millimeter		Inches	
	Min.	Max.	Min.	Max.
A	4.7	5.3	.185	.209
A ₁	2.2	2.54	.087	.102
A ₂	2.2	2.6	.059	.098
b	1.0	1.4	.040	.055
b ₁	1.65	2.13	.065	.084
b ₂	2.87	3.12	.113	.123
C	.4	.8	.016	.031
D	20.80	21.46	.819	.845
E	15.75	16.26	.610	.640
e	5.20	5.72	0.205	0.225
L	19.81	20.32	.780	.800
L1		4.50		.177
ØP	3.55	3.65	.140	.144
Q	5.89	6.40	0.232	0.252
R	4.32	5.49	.170	.216
S		6.15 BSC		242 BSC

TO-3P (IXTQ) Outline

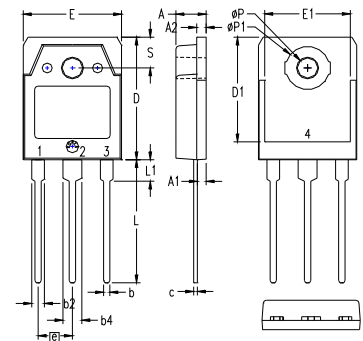

Terminals: 1 - Gate 2 - Drain
3 - Source

SYM	INCHES		MILLIMETERS	
	MIN	MAX	MIN	MAX
A	.185	.193	4.70	4.90
A1	.051	.059	1.30	1.50
A2	.057	.065	1.45	1.65
b	.035	.045	0.90	1.15
b2	.075	.087	1.90	2.20
b4	.114	.126	2.90	3.20
c	.022	.031	0.55	0.80
D	.780	.799	19.80	20.30
D1	.665	.677	16.90	17.20
E	.610	.622	15.50	15.80
E1	.531	.539	13.50	13.70
e	.215 BSC		5.45 BSC	
L	.779	.795	19.80	20.20
L1	.134	.142	3.40	3.60
ØP	.126	.134	3.20	3.40
ØP1	.272	.280	6.90	7.10
S	.193	.201	4.90	5.10

Fig. 1. Output Characteristics @ $T_J = 25^\circ\text{C}$

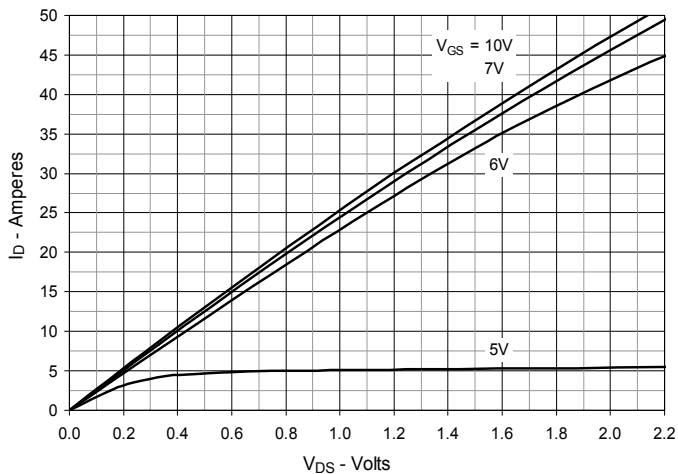

Fig. 2. Extended Output Characteristics @ $T_J = 25^\circ\text{C}$

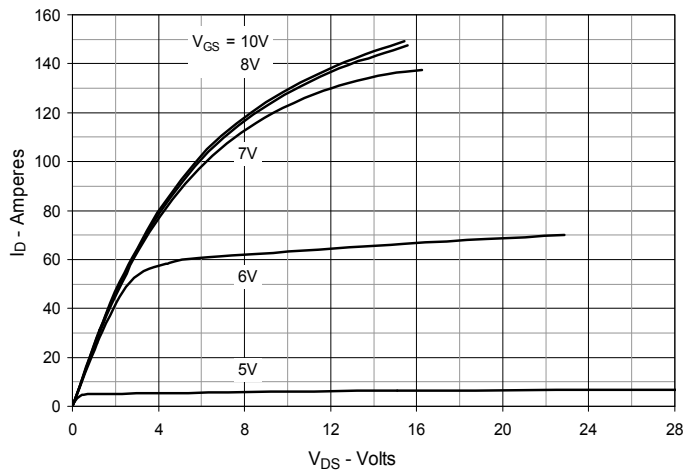

Fig. 3. Output Characteristics @ $T_J = 125^\circ\text{C}$

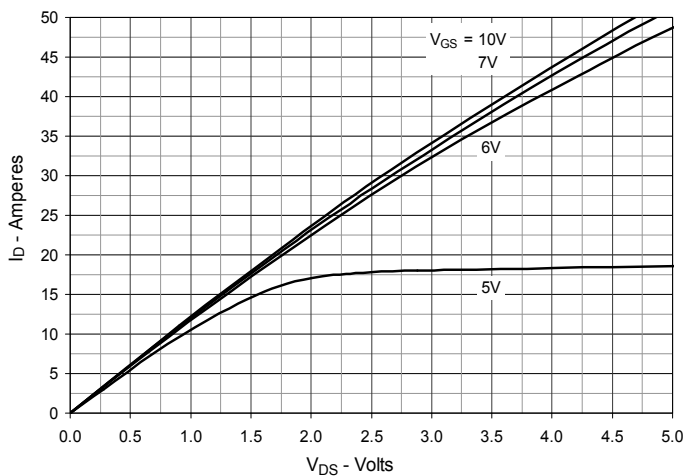

Fig. 4. $R_{DS(on)}$ Normalized to $I_D = 25\text{A}$ Value vs. Junction Temperature

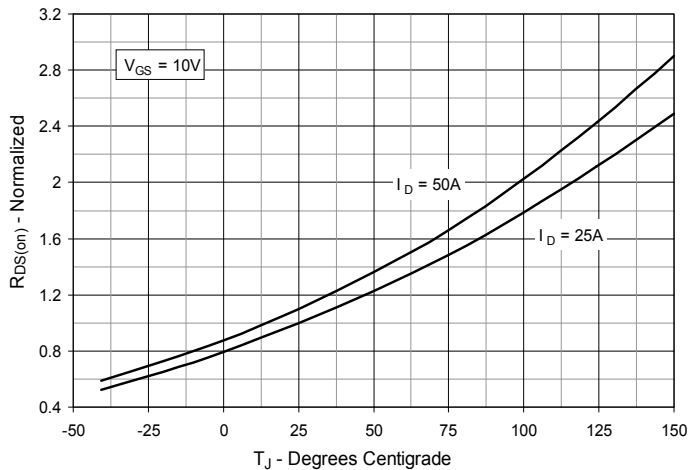

Fig. 5. $R_{DS(on)}$ Normalized to $I_D = 25\text{A}$ Value vs. Drain Current

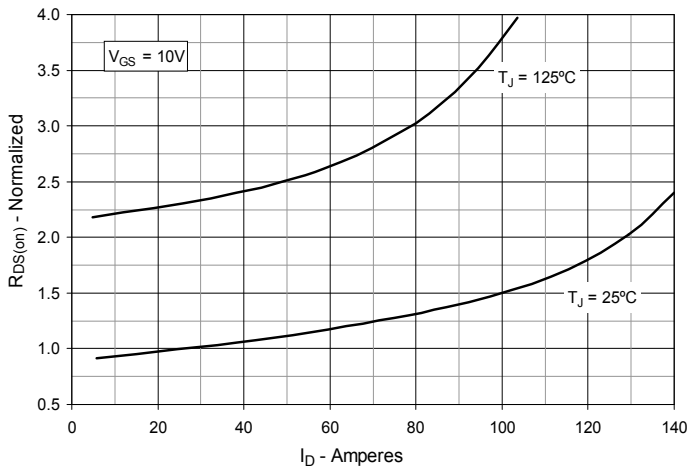

Fig. 6. Maximum Drain Current vs. Case Temperature

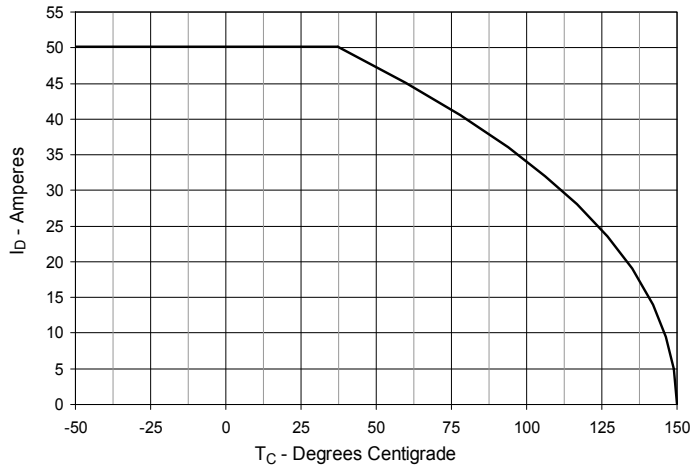

Fig. 7. Input Admittance

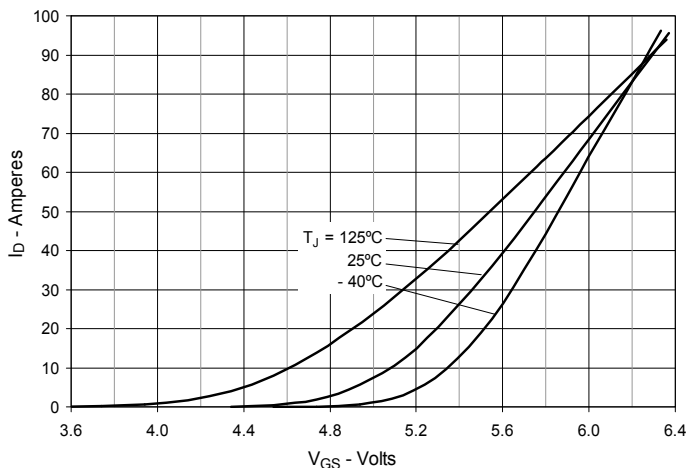

Fig. 8. Transconductance

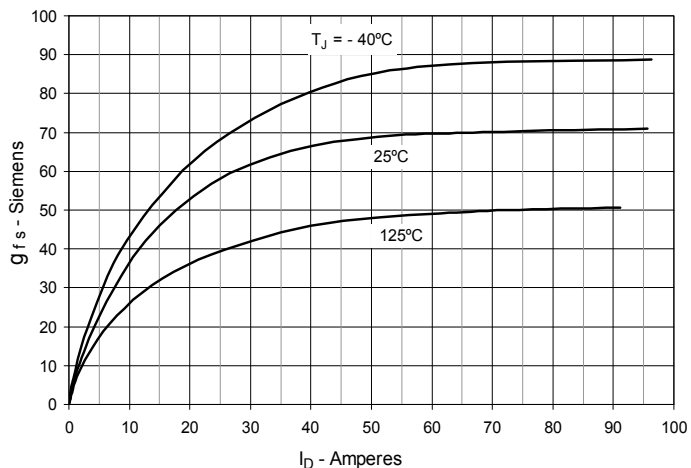

Fig. 9. Forward Voltage Drop of Intrinsic Diode

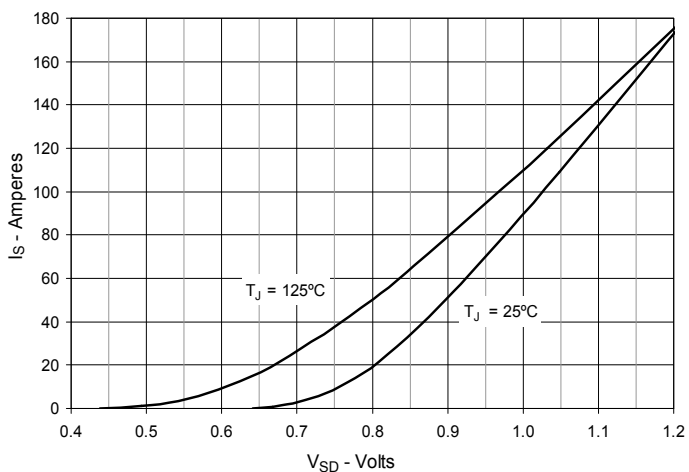

Fig. 10. Gate Charge

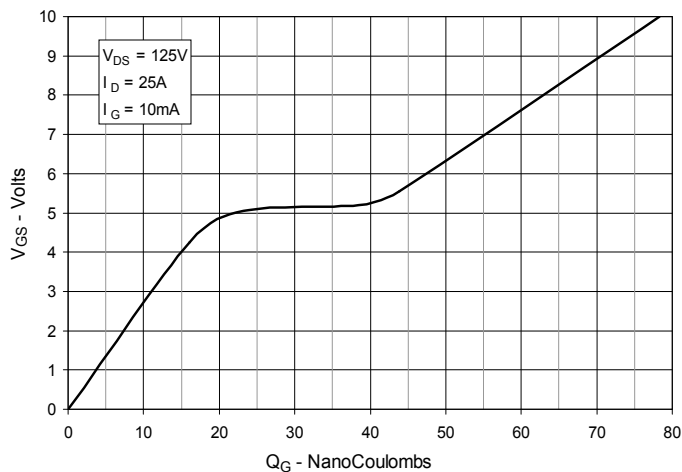

Fig. 11. Capacitance

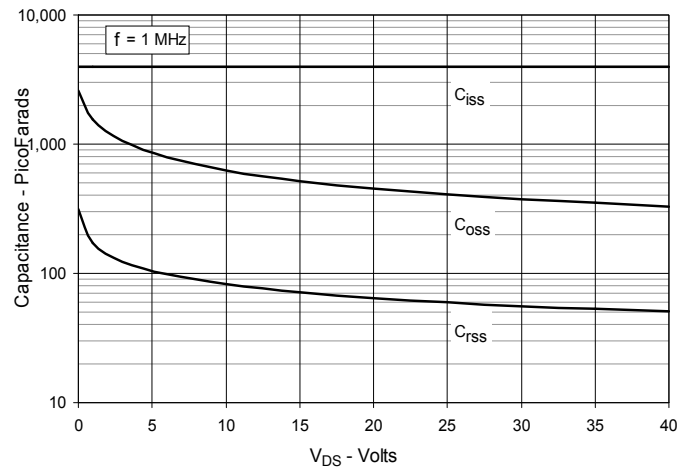
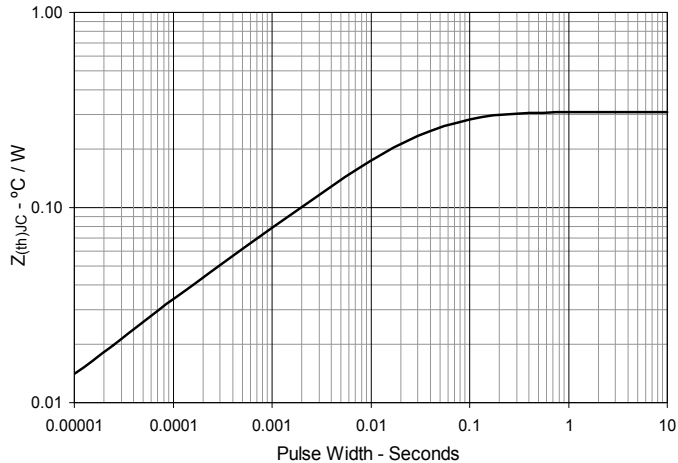
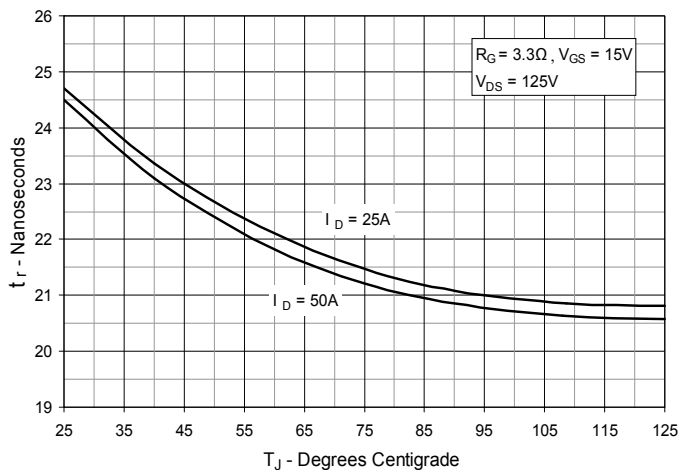

Fig. 12. Maximum Transient Thermal Impedance



**Fig. 13. Resistive Turn-on
Rise Time vs. Junction Temperature**



**Fig. 14. Resistive Turn-on
Rise Time vs. Drain Current**

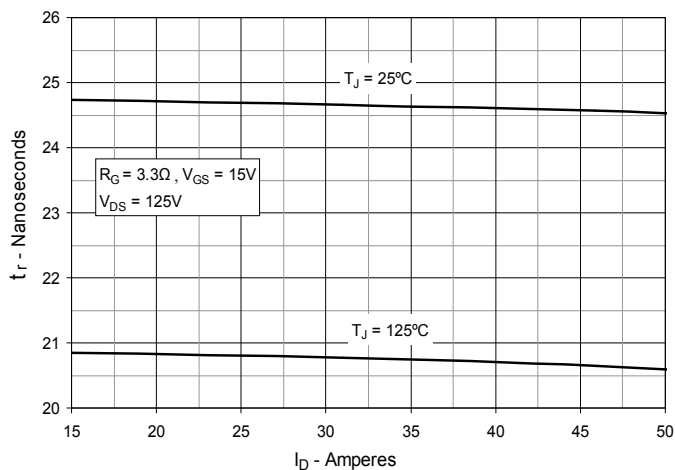

**Fig. 15. Resistive Turn-on
Switching Times vs. Gate Resistance**

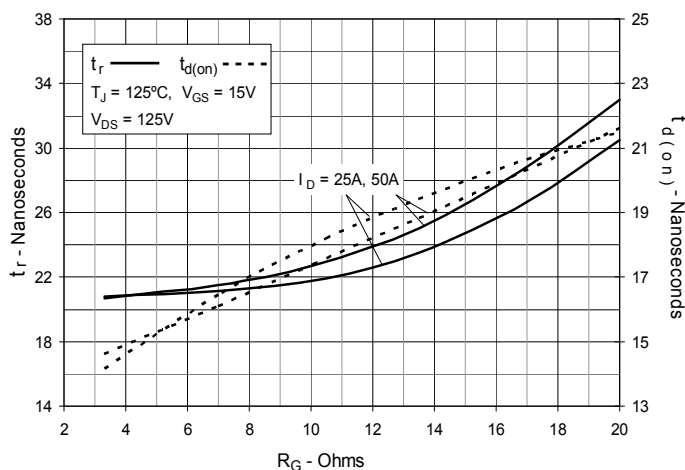

**Fig. 16. Resistive Turn-off
Switching Times vs. Junction Temperature**

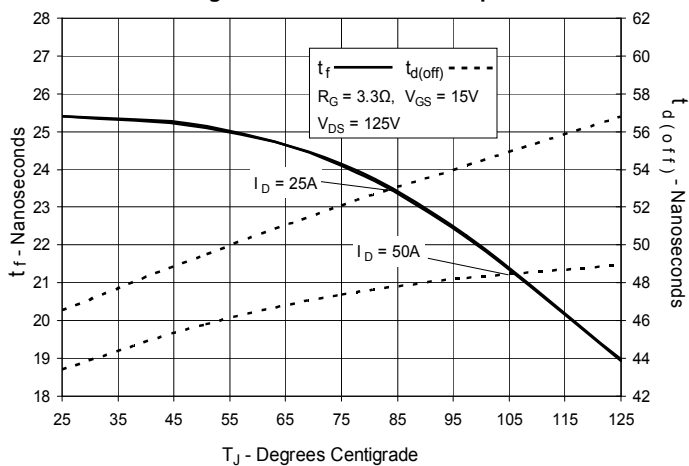

**Fig. 17. Resistive Turn-off
Switching Times vs. Drain Current**

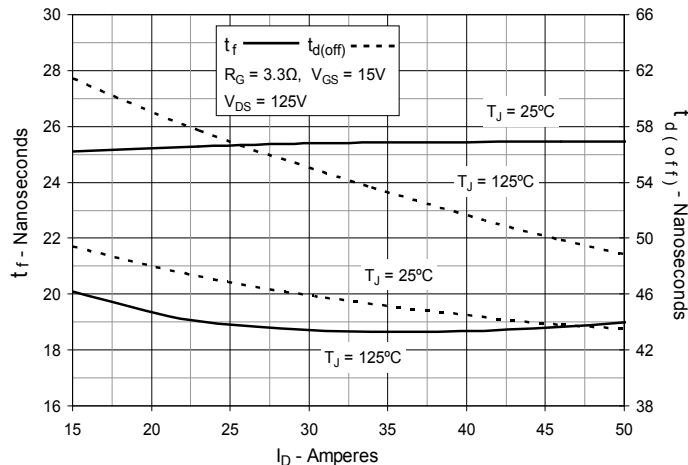

**Fig. 18. Resistive Turn-off
Switching Times vs. Gate Resistance**

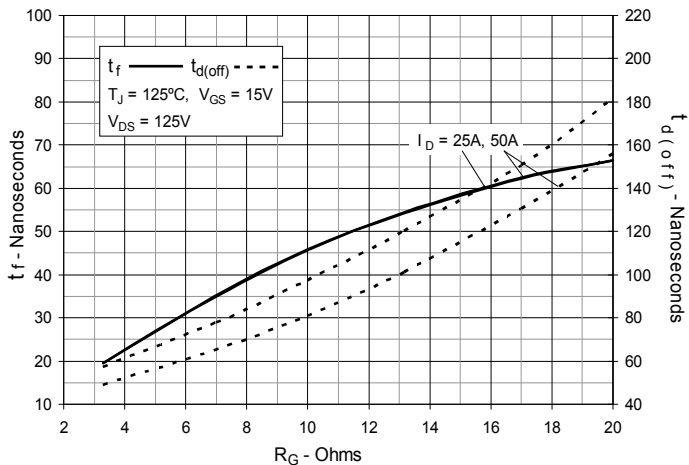

Mouser Electronics

Authorized Distributor

Click to View Pricing, Inventory, Delivery & Lifecycle Information:

[IXYS:](#)

[IXTP50N25T](#) [IXTQ50N25T](#) [IXTA50N25T](#) [IXTH50N25T](#)