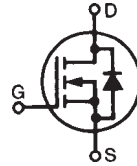

TrenchT4™
Power MOSFET
IXTP270N04T4
IXTH270N04T4

$$V_{DSS} = 40V$$

$$I_{D25} = 270A$$

$$R_{DS(on)} \leq 2.4m\Omega$$

 N-Channel Enhancement Mode
 Avalanche Rated

Symbol	Test Conditions	Maximum Ratings	
V_{DSS}	$T_J = 25^\circ C$ to $175^\circ C$	40	V
V_{DGR}	$T_J = 25^\circ C$ to $175^\circ C$, $R_{GS} = 1M\Omega$	40	V
V_{GSM}	Transient	± 15	V
I_{D25}	$T_C = 25^\circ C$	270	A
I_{LRMS}	Lead Current Limit, RMS	160	A
I_{DM}	$T_C = 25^\circ C$, Pulse Width Limited by T_{JM}	800	A
I_A	$T_C = 25^\circ C$	135	A
E_{AS}	$T_C = 25^\circ C$	750	mJ
I_A	$T_C = 25^\circ C$	270	A
E_{AS}	$T_C = 25^\circ C$	350	mJ
P_D	$T_C = 25^\circ C$	375	W
T_J		-55 ... +175	$^\circ C$
T_{JM}		175	$^\circ C$
T_{stg}		-55 ... +175	$^\circ C$
T_L	Maximum Lead Temperature for Soldering	300	$^\circ C$
T_{SOLD}	1.6 mm (0.062in.) from Case for 10s	260	$^\circ C$
M_d	Mounting Torque	1.13 / 10	Nm/lb.in
Weight	TO-220	3	g
	TO-247	6	g

Symbol	Test Conditions ($T_J = 25^\circ C$ Unless Otherwise Specified)	Characteristic Values		
		Min.	Typ.	Max.
BV_{DSS}	$V_{GS} = 0V$, $I_D = 250\mu A$	40		V
$V_{GS(th)}$	$V_{DS} = V_{GS}$, $I_D = 250\mu A$	2.0		4.0 V
I_{GSS}	$V_{GS} = \pm 15V$, $V_{DS} = 0V$			± 200 nA
I_{DSS}	$V_{DS} = V_{DSS}$, $V_{GS} = 0V$ $T_J = 150^\circ C$			5 μA
				750 μA
$R_{DS(on)}$	$V_{GS} = 10V$, $I_D = 50A$, Note 1			2.4 m Ω

TO-220AB (IXTP)

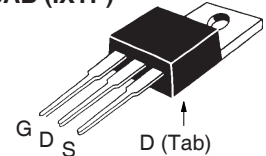

TO-247 (IXTH)

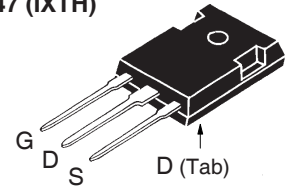
 G = Gate D = Drain
 S = Source Tab = Drain

Features

- International Standard Packages
- 175 $^\circ C$ Operating Temperature
- High Current Handling Capability
- Avalanche Rated
- Low $R_{DS(on)}$

Advantages

- Easy to Mount
- Space Savings
- High Power Density

Applications

- Synchronous Buck Converters
- High Current Switching Power Supplies
- Battery Powered Electric Motors
- Resonant-Mode Power Supplies
- Electronics Ballast Application
- Class D Audio Amplifiers

Symbol	Test Conditions ($T_J = 25^\circ\text{C}$, Unless Otherwise Specified)	Characteristic Values		
		Min.	Typ.	Max.
g_{fs}	$V_{DS} = 10\text{V}$, $I_D = 60\text{A}$, Note 1	90	150	S
R_{Gi}	Gate Input Resistance		1.4	Ω
C_{iss}	$V_{GS} = 0\text{V}$, $V_{DS} = 25\text{V}$, $f = 1\text{MHz}$		9140	pF
C_{oss}			1450	pF
C_{rss}			980	pF
$t_{d(on)}$	Resistive Switching Times $V_{GS} = 10\text{V}$, $V_{DS} = 0.5 \cdot V_{DSS}$, $I_D = 135\text{A}$ $R_G = 2\Omega$ (External)		18	ns
t_r			28	ns
$t_{d(off)}$			72	ns
t_f			23	ns
$Q_{g(on)}$	$V_{GS} = 10\text{V}$, $V_{DS} = 0.5 \cdot V_{DSS}$, $I_D = 0.5 \cdot I_{D25}$		182	nC
Q_{gs}			45	nC
Q_{gd}			67	nC
R_{thJC}	TO-220			0.40 $^\circ\text{C/W}$
R_{thCS}		TO-247	0.50	$^\circ\text{C/W}$
			0.21	$^\circ\text{C/W}$

Source-Drain Diode

Symbol	Test Conditions ($T_J = 25^\circ\text{C}$, Unless Otherwise Specified)	Characteristic Values		
		Min.	Typ.	Max.
I_S	$V_{GS} = 0\text{V}$			270 A
I_{SM}	Repetitive, Pulse width limited by T_{JM}			1080 A
V_{SD}	$I_F = 100\text{A}$, $V_{GS} = 0\text{V}$, Note 1			1.4 V
t_{rr}	$I_F = 150\text{A}$, $V_{GS} = 0\text{V}$ $-di/dt = 100\text{A}/\mu\text{s}$ $V_R = 30\text{V}$		48	ns
I_{RM}			1.8	A
Q_{RM}			43	nC

- Notes: 1. Pulse test, $t \leq 300\mu\text{s}$, duty cycle, $d \leq 2\%$.
2. On through-hole packages, $R_{DS(on)}$ Kelvin test contact location must be 5mm or less from the package body.

PRELIMINARY TECHNICAL INFORMATION

The product presented herein is under development. The Technical Specifications offered are derived from a subjective evaluation of the design, based upon prior knowledge and experience, and constitute a "considered reflection" of the anticipated result. IXYS reserves the right to change limits, test conditions, and dimensions without notice.

IXYS Reserves the Right to Change Limits, Test Conditions, and Dimensions.

IXYS MOSFETs and IGBTs are covered by one or more of the following U.S. patents:

4,835,592	4,931,844	5,049,961	5,237,481	6,162,665	6,404,065 B1	6,683,344	6,727,585	7,005,734 B2	7,157,338B2
4,860,072	5,017,508	5,063,307	5,381,025	6,259,123 B1	6,534,343	6,710,405 B2	6,759,692	7,063,975 B2	
4,881,106	5,034,796	5,187,117	5,486,715	6,306,728 B1	6,583,505	6,710,463	6,771,478 B2	7,071,537	

Fig. 1. Output Characteristics @ $T_J = 25^\circ\text{C}$

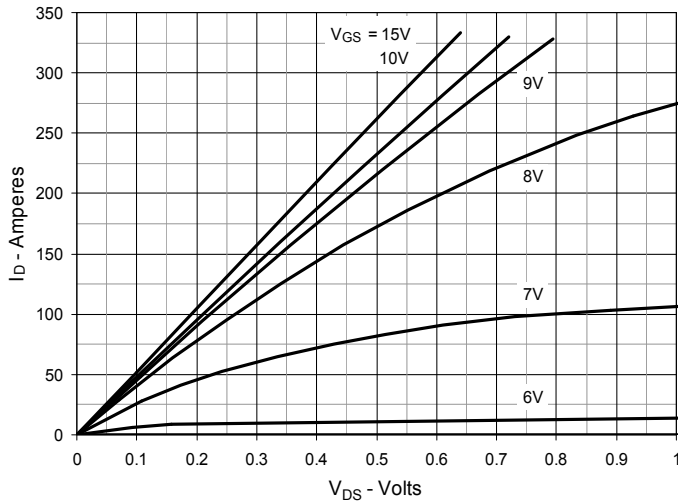

Fig. 2. Extended Output Characteristics @ $T_J = 25^\circ\text{C}$

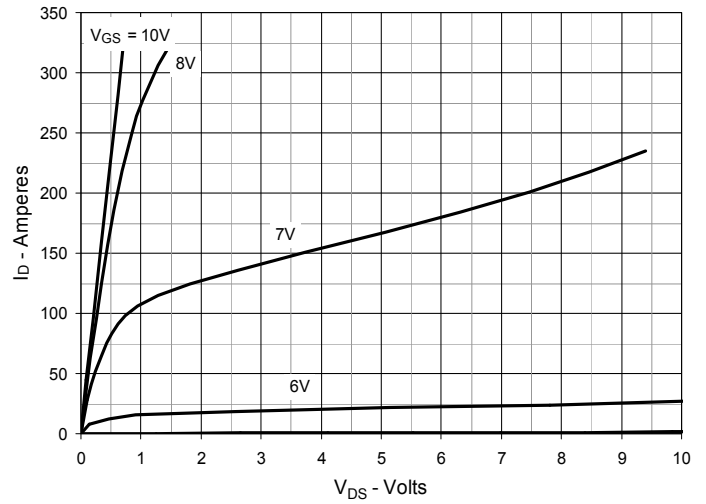

Fig. 3. Output Characteristics @ $T_J = 150^\circ\text{C}$

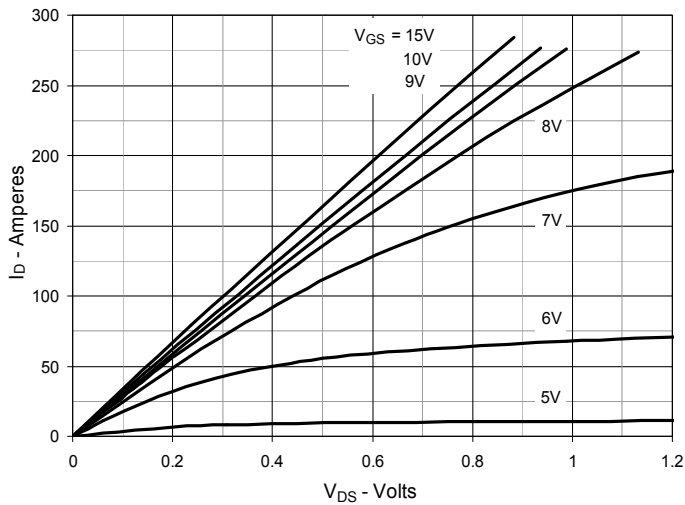

Fig. 4. Normalized $R_{DS(on)}$ to $I_D = 135\text{A}$ Value vs. Junction Temperature

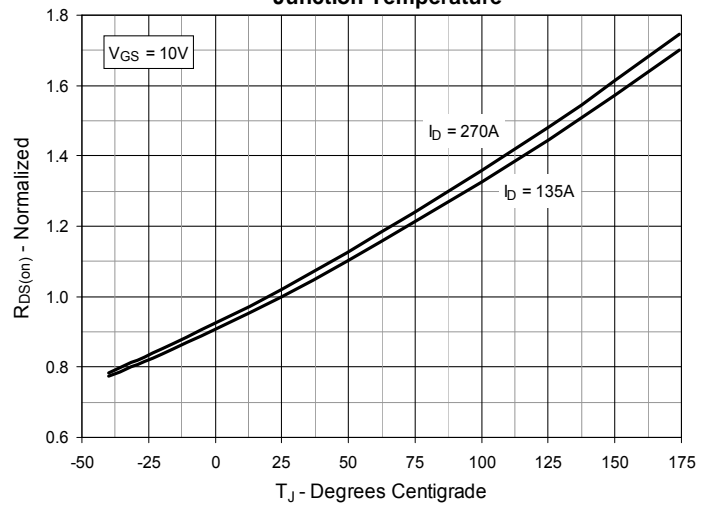

Fig. 5. Normalized $R_{DS(on)}$ to $I_D = 135\text{A}$ vs. Drain Current

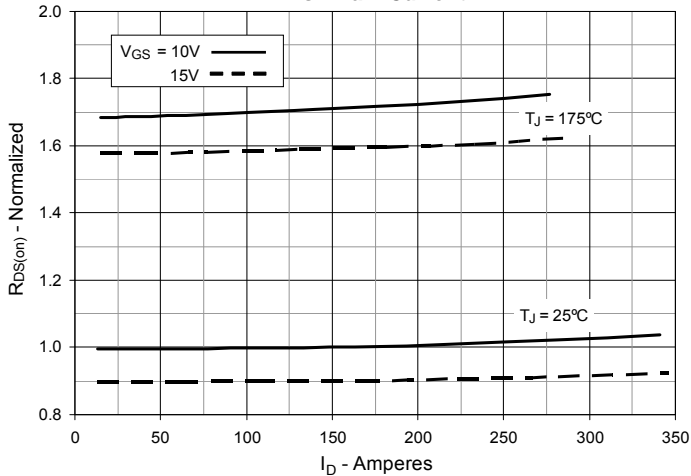

Fig. 6. Drain Current vs. Case Temperature

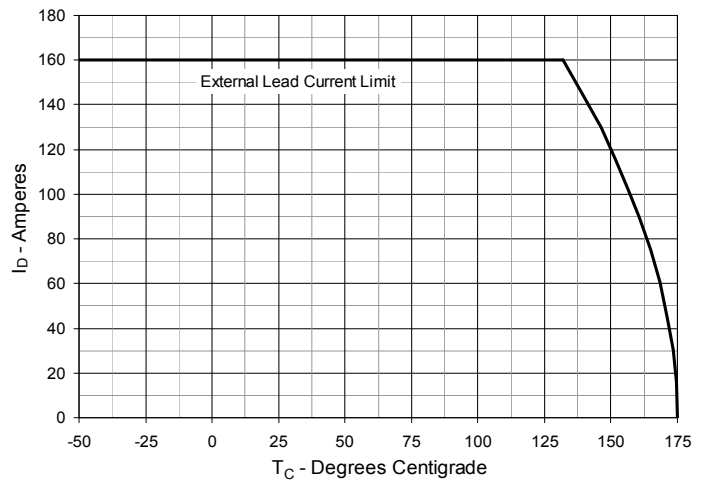

Fig. 7. Input Admittance

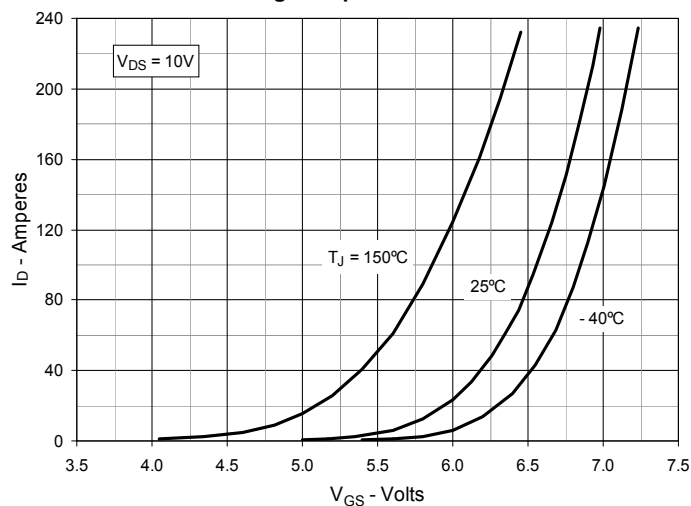

Fig. 8. Transconductance

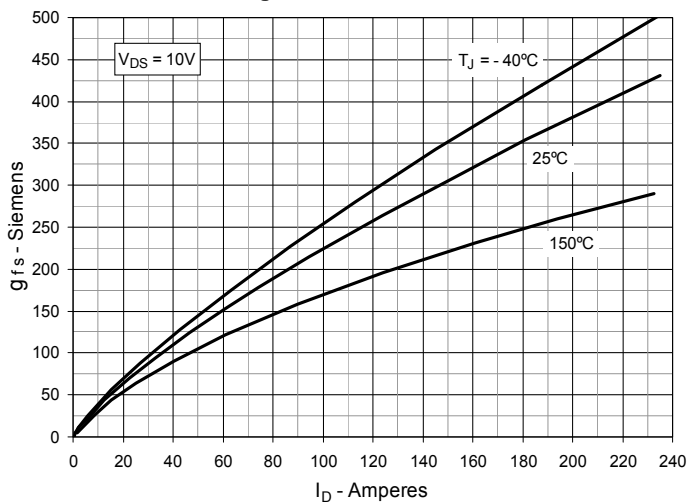

Fig. 9. Forward Voltage Drop of Intrinsic Diode

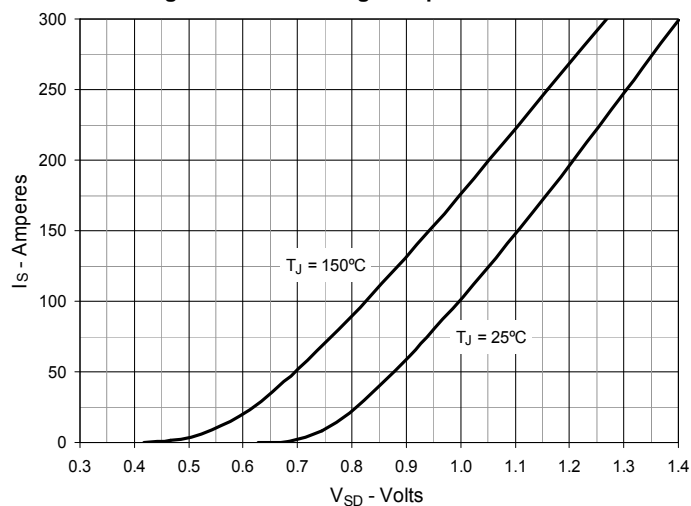

Fig. 10. Gate Charge

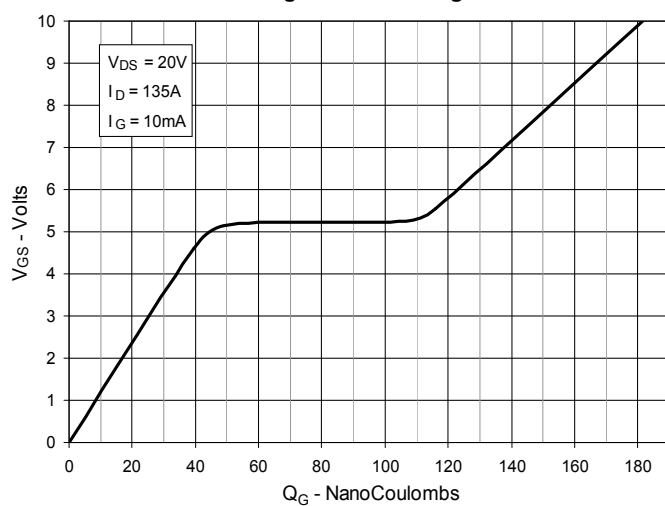

Fig. 11. Capacitance

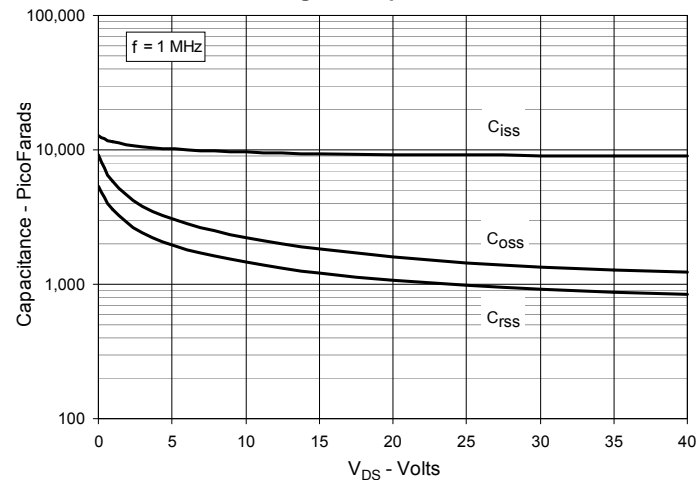

Fig. 12. Forward-Bias Safe Operating Area

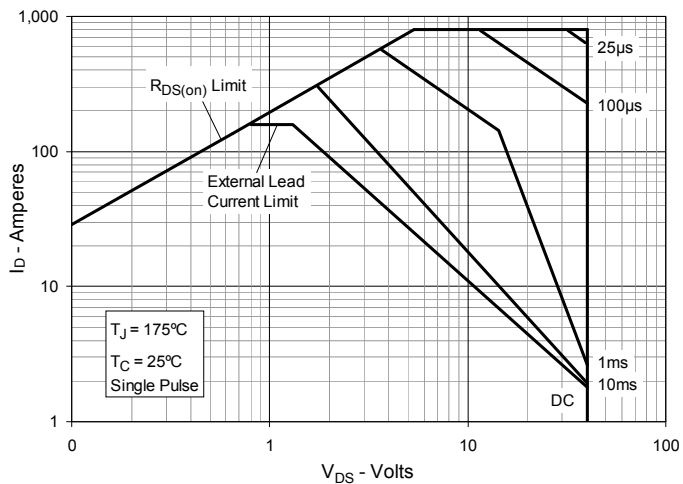

Fig. 13. Resistive Turn-on Rise Time vs. Junction Temperature

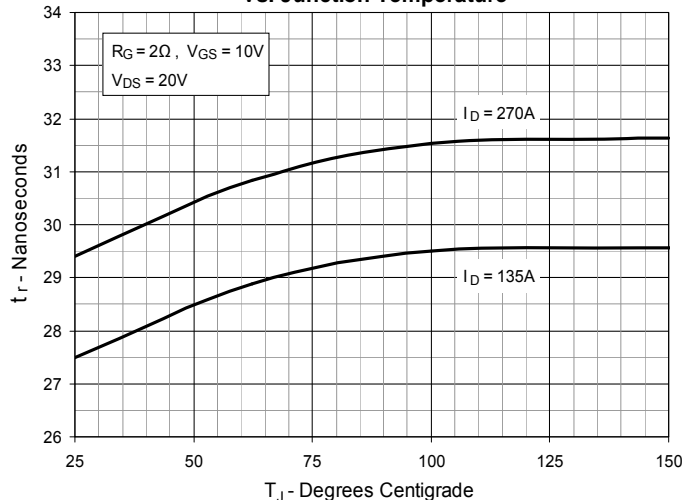

Fig. 14. Resistive Turn-on Rise Time vs. Drain Current

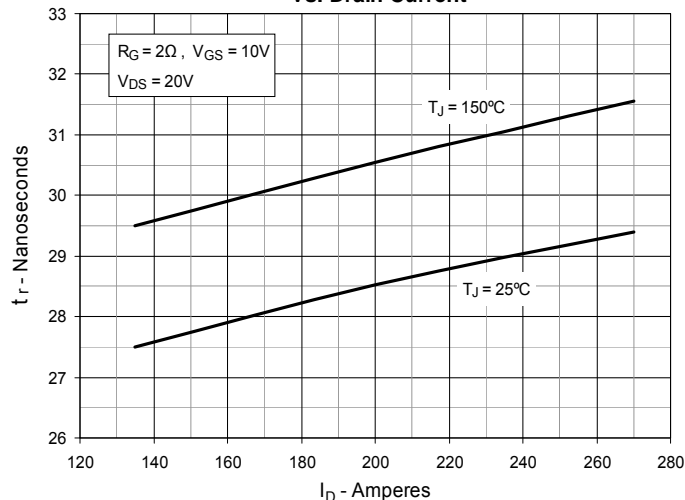

Fig. 15. Resistive Turn-on Switching Times vs. Gate Resistance

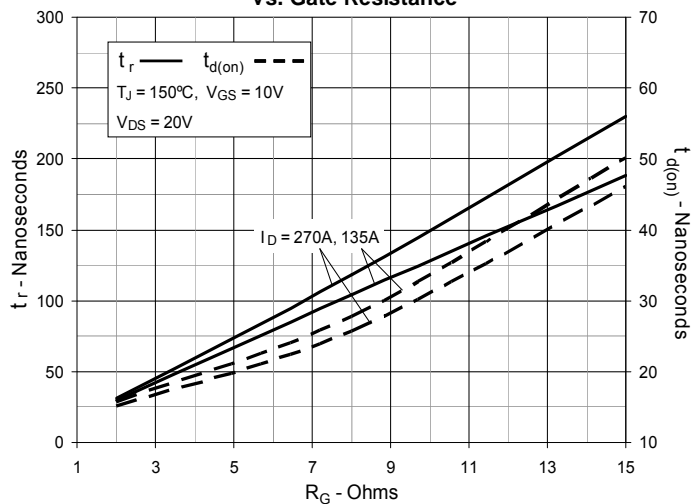

Fig. 16. Resistive Turn-off Switching Times vs. Junction Temperature

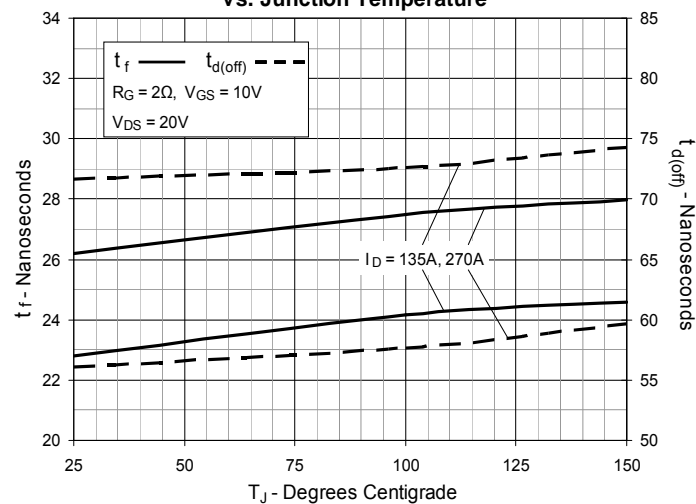

Fig. 17. Resistive Turn-off Switching Times vs. Drain Current

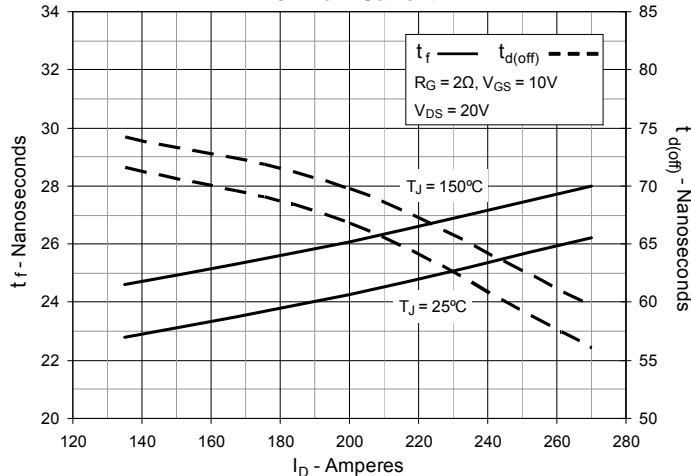

Fig. 18. Resistive Turn-off Switching Times vs. Gate Resistance

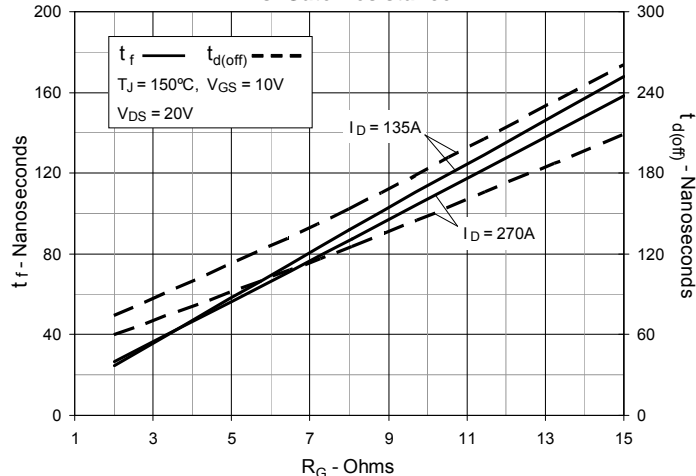
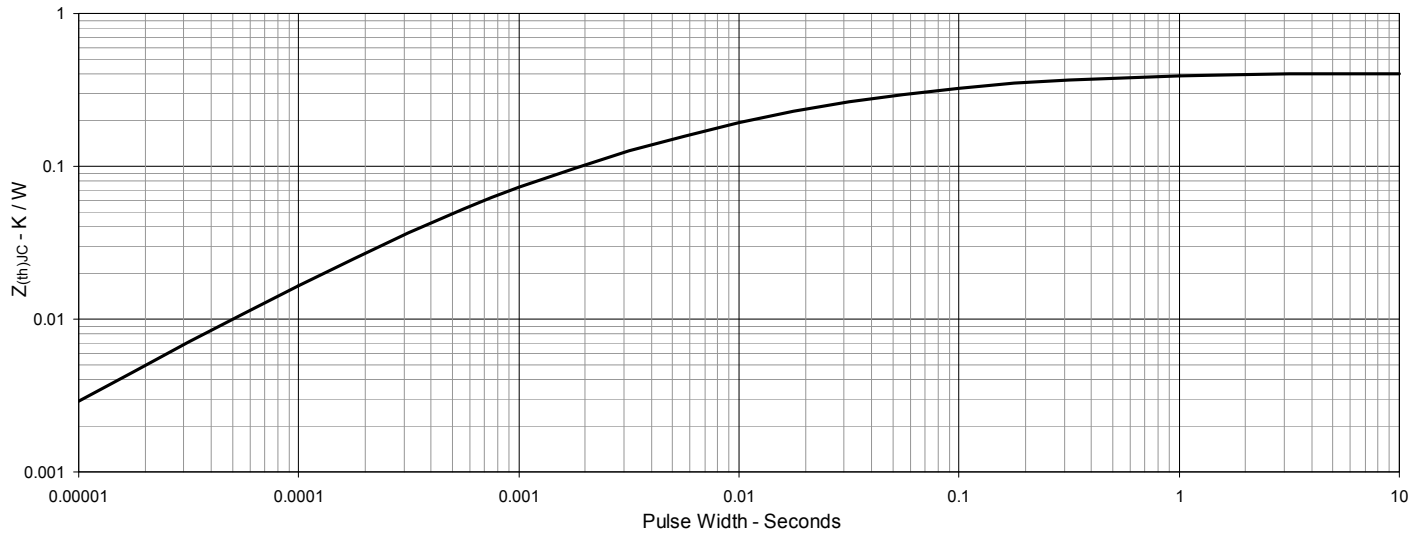
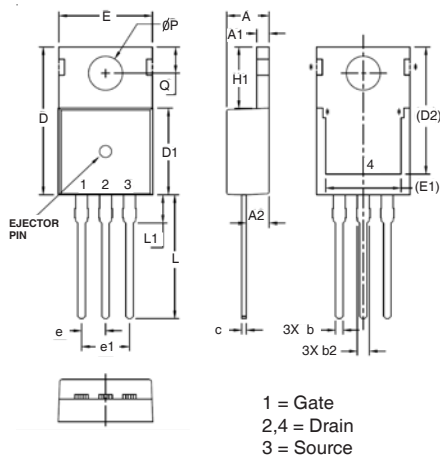

Fig. 19. Maximum Transient Thermal Impedance



TO-220 (IXTP) Outline



SYM	INCHES		MILLIMETERS	
	MIN	MAX	MIN	MAX
A	.169	.185	4.30	4.70
A1	.047	.055	1.20	1.40
A2	.079	.106	2.00	2.70
b	.024	.039	0.60	1.00
b2	.045	.057	1.15	1.45
c	.014	.026	0.35	0.65
D	.587	.626	14.90	15.90
D1	.335	.370	8.50	9.40
(D2)	.500	.531	12.70	13.50
E	.382	.406	9.70	10.30
(E1)	.283	.323	7.20	8.20
e	.100 BSC		2.54 BSC	
e1	.200 BSC		5.08 BSC	
H1	.244	.268	6.20	6.80
L	.492	.547	12.50	13.90
L1	.110	.154	2.80	3.90
ØP	.134	.150	3.40	3.80
Q	.106	.126	2.70	3.20

TO-220 (IXTH) Outline

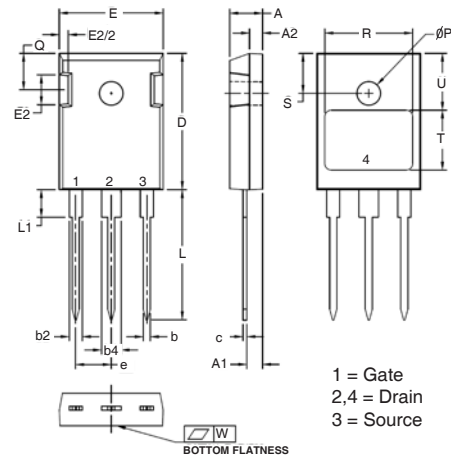

SYM	INCHES		MILLIMETERS	
	MIN	MAX	MIN	MAX
A	.190	.205	4.83	5.21
A1	.087	.100	2.21	2.54
A2	.075	.085	1.91	2.16
b	.045	.055	1.14	1.40
b2	.075	.085	1.91	2.16
b4	.115	.126	2.92	3.20
c	.023	.033	0.58	0.84
D	.820	.840	20.83	21.34
E	.620	.635	15.75	16.13
E2	.175	.195	4.44	4.95
e	.215 BSC		5.45 BSC	
L	.780	.810	19.81	20.57
L1	.160	.177	4.06	4.50
Q	.220	.240	5.59	6.10
R	.520	.540	13.21	13.72
S	.242 BSC		6.15 BSC	
T	.355	.375	9.02	9.53
U	.345	.370	8.76	9.40
ØP	.140	.144	3.55	3.66
W	.000	.004	0.00	0.10

Mouser Electronics

Authorized Distributor

Click to View Pricing, Inventory, Delivery & Lifecycle Information:

[IXYS:](#)

[IXTH270N04T4](#) [IXTP270N04T4](#)