

# IRF5806PbF

HEXFET<sup>®</sup> Power MOSFET

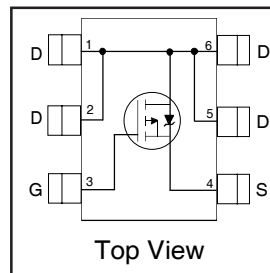
- Ultra Low On-Resistance
- P-Channel MOSFET
- Surface Mount
- Available in Tape & Reel
- Low Gate Charge
- Lead-Free
- Halogen-Free

$V_{DSS}$	$R_{DS(on) \max}$	$I_D$
-20V	86m $\Omega$ @ $V_{GS} = -4.5V$	-4.0A
	147m $\Omega$ @ $V_{GS} = -2.5V$	-3.0A

## Description

These P-channel MOSFETs from International Rectifier utilize advanced processing techniques to achieve the extremely low on-resistance per silicon area. This benefit provides the designer with an extremely efficient device for use in battery and load management applications.

The TSOP-6 package with its customized leadframe produces a HEXFET<sup>®</sup> power MOSFET with  $R_{DS(on)}$  60% less than a similar size SOT-23. This package is ideal for applications where printed circuit board space is at a premium. It's unique thermal design and  $R_{DS(on)}$  reduction enables a current-handling increase of nearly 300% compared to the SOT-23.



## Absolute Maximum Ratings

	Parameter	Max.	Units
$V_{DS}$	Drain-Source Voltage	-20	V
$I_D @ T_A = 25^\circ C$	Continuous Drain Current, $V_{GS} @ -4.5V$	-4.0	A
$I_D @ T_A = 70^\circ C$	Continuous Drain Current, $V_{GS} @ -4.5V$	-3.3	
$I_{DM}$	Pulsed Drain Current <sup>①</sup>	-16.5	
$P_D @ T_A = 25^\circ C$	Maximum Power Dissipation <sup>③</sup>	2.0	W
$P_D @ T_A = 70^\circ C$	Maximum Power Dissipation <sup>③</sup>	1.3	W
	Linear Derating Factor	0.02	W/ $^\circ C$
$V_{GS}$	Gate-to-Source Voltage	$\pm 20$	V
$T_J, T_{STG}$	Junction and Storage Temperature Range	-55 to + 150	$^\circ C$


## Thermal Resistance

	Parameter	Max.	Units
$R_{\theta JA}$	Maximum Junction-to-Ambient <sup>③</sup>	62.5	$^\circ C/W$

## Electrical Characteristics @ $T_J = 25^\circ\text{C}$ (unless otherwise specified)

	Parameter	Min.	Typ.	Max.	Units	Conditions
$V_{(BR)DSS}$	Drain-to-Source Breakdown Voltage	-20	—	—	V	$V_{GS} = 0V, I_D = -250\mu A$
$\Delta V_{(BR)DSS}/\Delta T_J$	Breakdown Voltage Temp. Coefficient	—	0.011	—	V/°C	Reference to $25^\circ\text{C}, I_D = -1\text{mA}$
$R_{DS(on)}$	Static Drain-to-Source On-Resistance	—	47.1	86	mΩ	$V_{GS} = -4.5V, I_D = -4.0A$ ②
		—	67.5	147		$V_{GS} = -2.5V, I_D = -3.0A$ ②
$V_{GS(th)}$	Gate Threshold Voltage	-0.45	—	-1.2	V	$V_{DS} = V_{GS}, I_D = -250\mu A$
$g_{fs}$	Forward Transconductance	6.4	—	—	S	$V_{DS} = -10V, I_D = -4.0A$
$I_{DSS}$	Drain-to-Source Leakage Current	—	—	-15	μA	$V_{DS} = -16V, V_{GS} = 0V$
		—	—	-25		$V_{DS} = -16V, V_{GS} = 0V, T_J = 70^\circ\text{C}$
$I_{GSS}$	Gate-to-Source Forward Leakage	—	—	-100	nA	$V_{GS} = -12V$
	Gate-to-Source Reverse Leakage	—	—	100		$V_{GS} = 12V$
$Q_g$	Total Gate Charge	—	8.3	11.4	nC	$I_D = -4.0A$
$Q_{gs}$	Gate-to-Source Charge	—	1.2	—		$V_{DS} = -16V$
$Q_{gd}$	Gate-to-Drain ("Miller") Charge	—	2.6	—		$V_{GS} = -4.5V$
$t_{d(on)}$	Turn-On Delay Time	—	6.2	9.3	ns	$V_{DD} = -10V, V_{GS} = -4.5V$
$t_r$	Rise Time	—	27	41		$I_D = -1.0A$
$t_{d(off)}$	Turn-Off Delay Time	—	94	140		$R_G = 6.0\Omega$
$t_f$	Fall Time	—	126	190		$R_D = 10\Omega$ ②
$C_{iss}$	Input Capacitance	—	594	—	pF	$V_{GS} = 0V$
$C_{oss}$	Output Capacitance	—	114	—		$V_{DS} = -15V$
$C_{rss}$	Reverse Transfer Capacitance	—	87	—		$f = 1.0\text{MHz}$

## Source-Drain Ratings and Characteristics

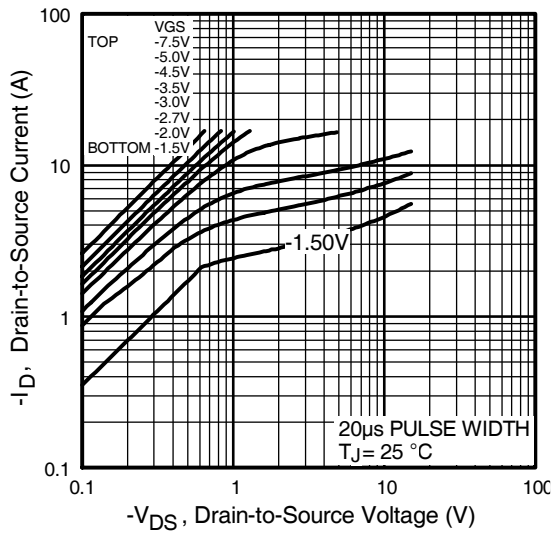
	Parameter	Min.	Typ.	Max.	Units	Conditions
$I_S$	Continuous Source Current (Body Diode)	—	—	-2.0	A	MOSFET symbol showing the integral reverse p-n junction diode. 
$I_{SM}$	Pulsed Source Current (Body Diode) ①	—	—	-16.5		
$V_{SD}$	Diode Forward Voltage	—	—	-1.2	V	$T_J = 25^\circ\text{C}, I_S = -2.0A, V_{GS} = 0V$ ②
$t_{rr}$	Reverse Recovery Time	—	116	174	ns	$T_J = 25^\circ\text{C}, I_F = -2.0A$
$Q_{rr}$	Reverse Recovery Charge	—	90	135	nC	$di/dt = -100A/\mu s$ ②

### Notes:

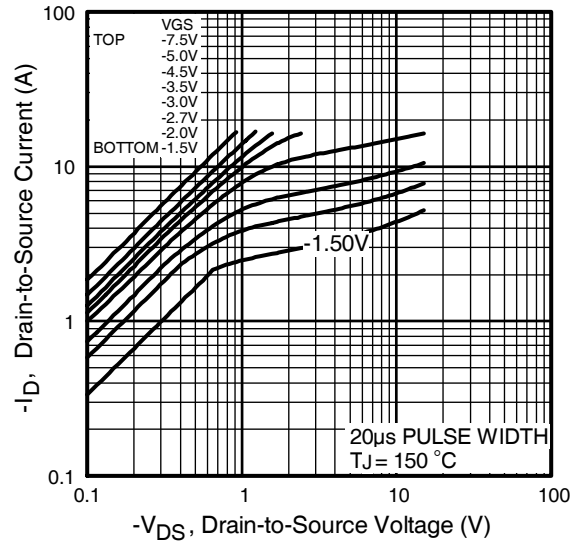
① Repetitive rating; pulse width limited by max. junction temperature.

② Pulse width  $\leq 300\mu s$ ; duty cycle  $\leq 2\%$ .

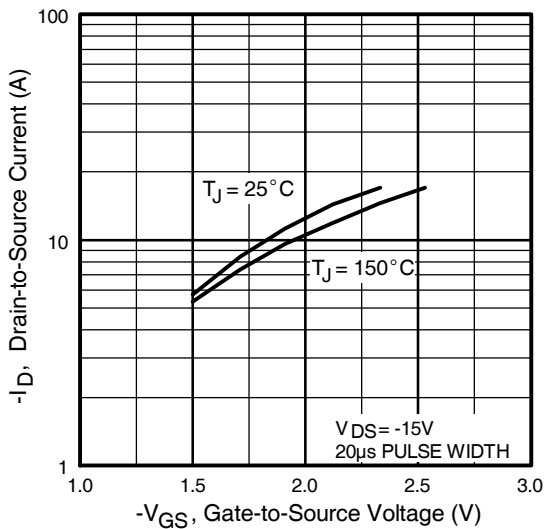
③ When mounted on 1 inch square Copper board,  $t \leq 10\text{sec}$ .



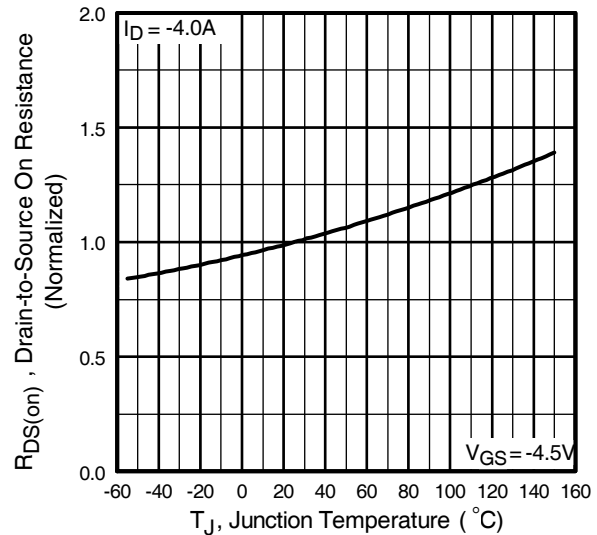
**Fig 1.** Typical Output Characteristics



**Fig 2.** Typical Output Characteristics



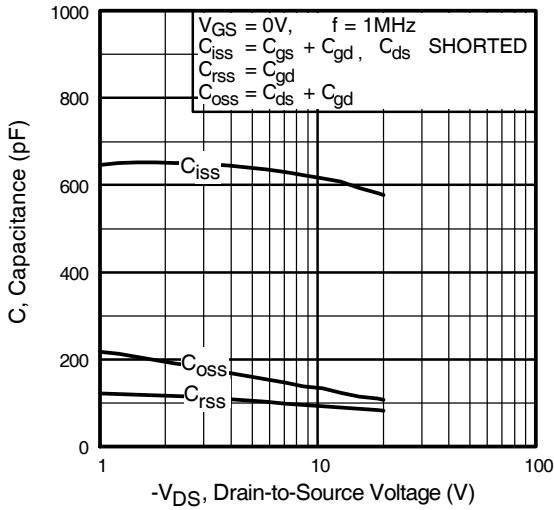
**Fig 3.** Typical Transfer Characteristics



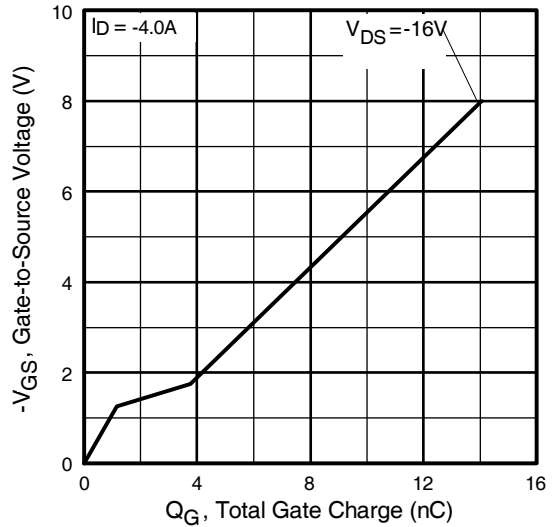
**Fig 4.** Normalized On-Resistance Vs. Temperature

# IRF5806PbF

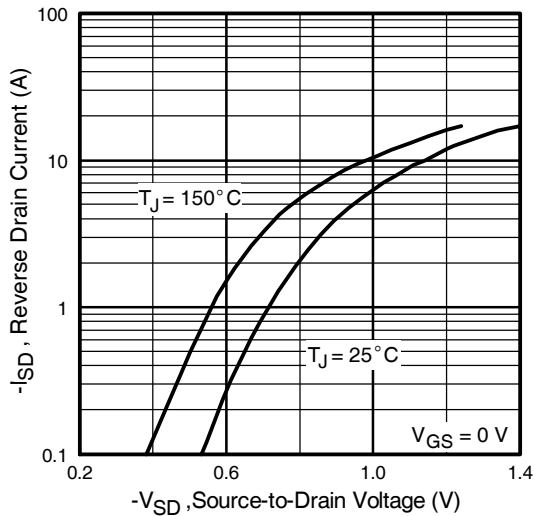
International  
**IR** Rectifier



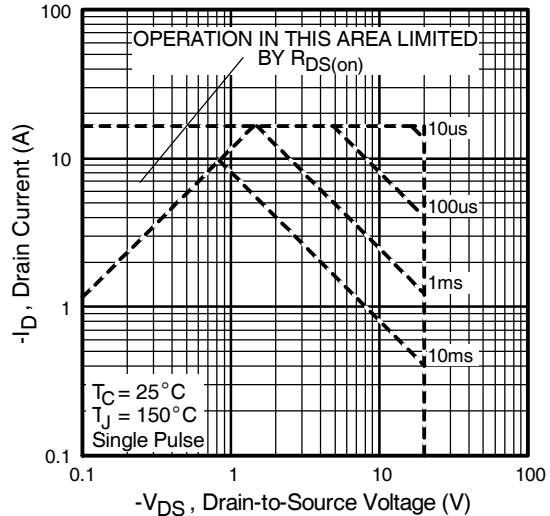
**Fig 5.** Typical Capacitance Vs. Drain-to-Source Voltage



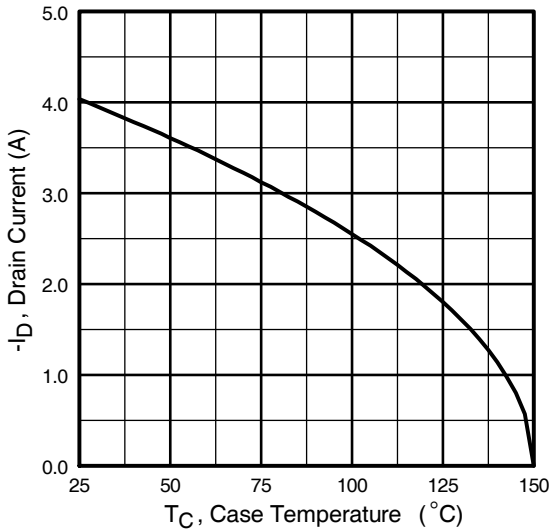
**Fig 6.** Typical Gate Charge Vs. Gate-to-Source Voltage



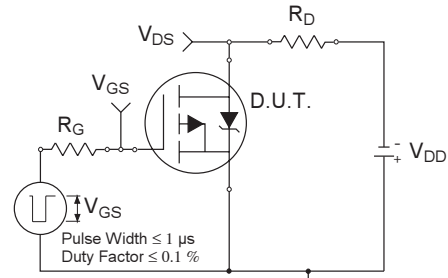
**Fig 7.** Typical Source-Drain Diode Forward Voltage



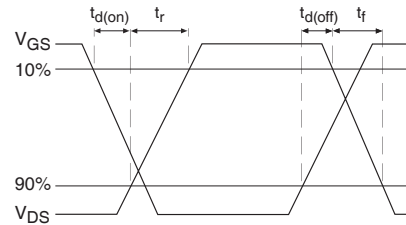
**Fig 8.** Maximum Safe Operating Area



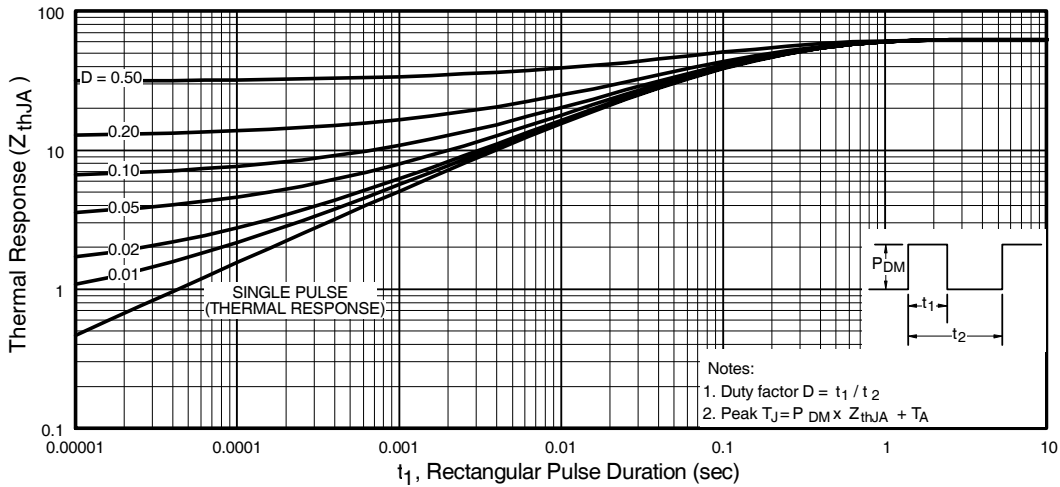
**Fig 9.** Maximum Drain Current Vs. Case Temperature



**Fig 10a.** Switching Time Test Circuit

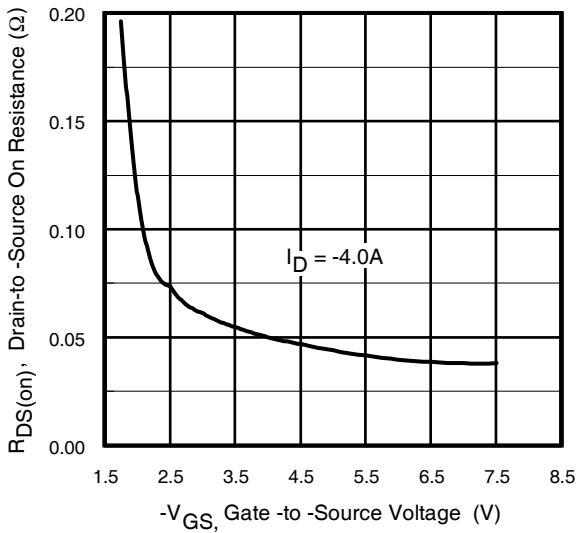


**Fig 10b.** Switching Time Waveforms

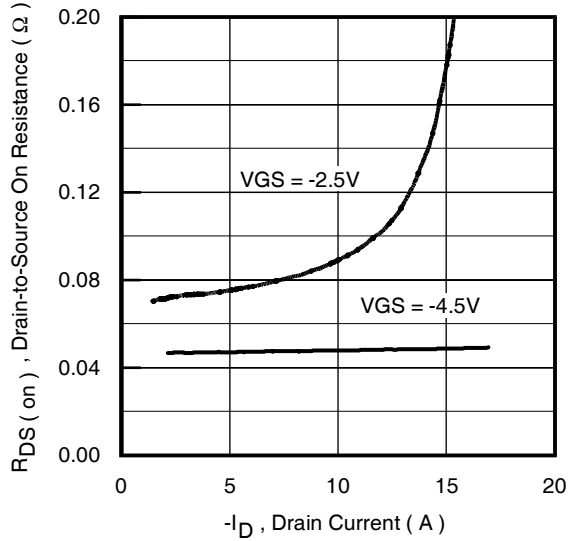


**Fig 11.** Maximum Effective Transient Thermal Impedance, Junction-to-Ambient

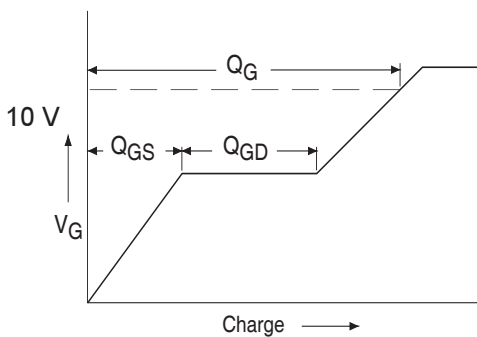
# IRF5806PbF



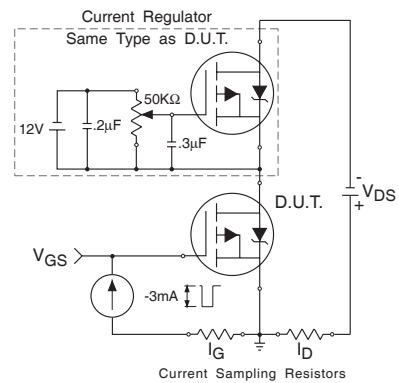
**Fig 12.** Typical On-Resistance Vs. Gate Voltage



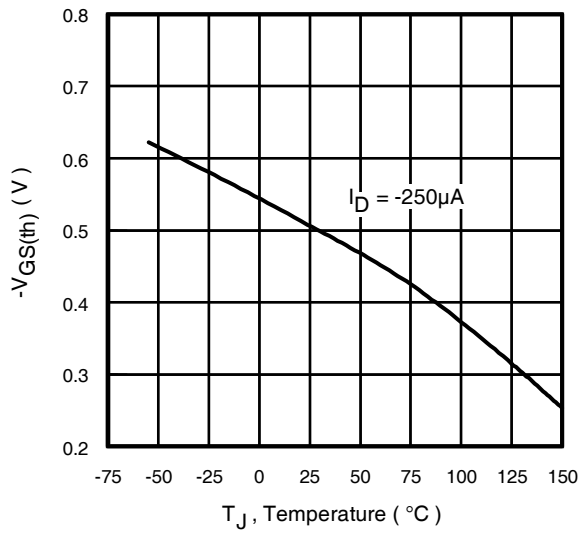
**Fig 13.** Typical On-Resistance Vs. Drain Current



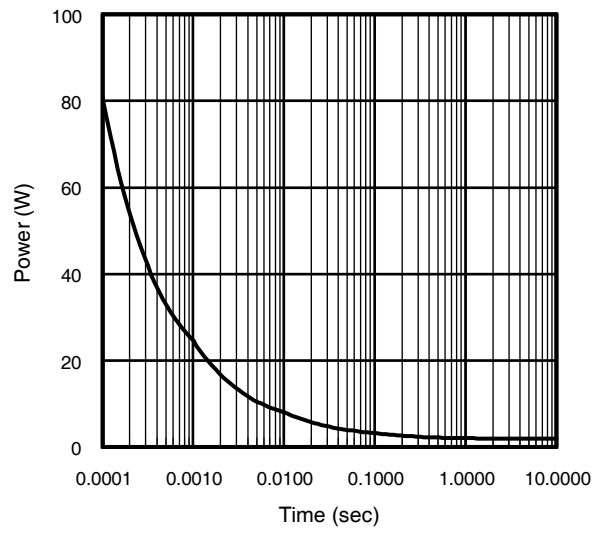
**Fig 14a.** Basic Gate Charge Waveform



**Fig 14b.** Gate Charge Test Circuit



**Fig 15.** Typical  $V_{GS(th)}$  Vs. Junction Temperature

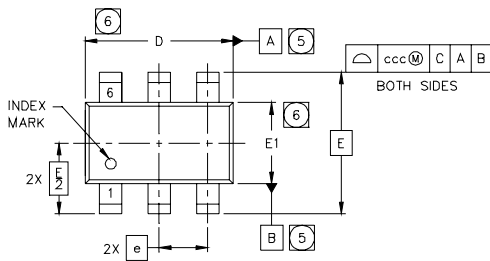


**Fig 16.** Typical Power Vs. Time

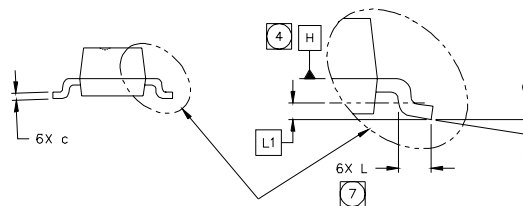
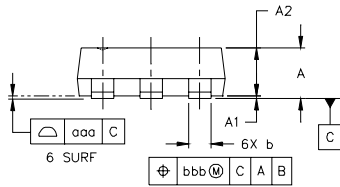
# IRF5806PbF

International  
**IR** Rectifier

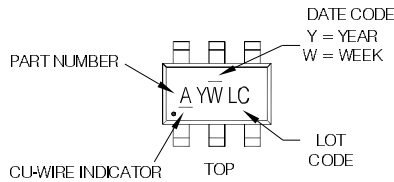
## TSOP-6 Package Outline



SYMBOL	MO-193AA DIMENSIONS					
	MILLIMETERS			INCHES		
	MIN	NOM	MAX	MIN	NOM	MAX
A	---	---	1.10	---	---	.0433
A1	0.01	---	0.10	.0004	---	.0039
A2	0.80	0.90	1.00	.0315	.0354	.0393
b	0.25	---	0.50	.0099	---	.0196
c	0.10	---	0.26	.004	---	.010
D	2.90	3.00	3.10	.115	.118	.122
E	2.75 BSC			.108 BSC		
E1	1.30	1.50	1.70	.052	.059	.066
e	1.00 BSC			.039 BSC		
L	0.20	0.40	0.60	.0079	.0157	.0236
L1	0.30 BSC			.0118 BSC		
θ	0°	---	8°	0°	---	8°
aaa	0.10			.004		
bbb	0.15			.006		
ccc	0.25			.010		



## TSOP-6 Part Marking Information



**PART NUMBER CODE REFERENCE:**

- |              |             |
|--------------|-------------|
| A = SI3443DV | K = IRF5810 |
| B = IRF5800  | L = IRF5804 |
| C = IRF5850  | M = IRF5803 |
| D = IRF5851  | N = IRF5802 |
| E = IRF5852  |             |
| F = IRF5801  |             |
| I = IRF5805  |             |
| J = IRF5806  |             |

**Notes:**

- A line above the work week (as shown here) indicates Lead-Free
- A line below the part number (as shown here) indicates Cu-wire

W = (1-26) IF PRECEDED BY LAST DIGIT OF CALENDAR YEAR

YEAR	Y	WORK WEEK	W
2001	1	01	A
2002	2	02	B
2003	3	03	C
2004	4	04	D
2005	5		
2006	6		
2007	7		
2008	8		
2009	9		
2010	0	24	X
		25	Y
		26	Z

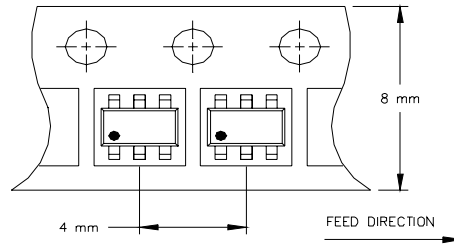
W = (27-52) IF PRECEDED BY A LETTER

YEAR	Y	WORK WEEK	W
2001	A	27	A
2002	B	28	B
2003	C	29	C
2004	D	30	D
2005	E		
2006	F		
2007	G		
2008	H		
2009	J		
2010	K	50	X
		51	Y
		52	Z

**Note:** For the most current drawing please refer to IR website at: <http://www.irf.com/package/>

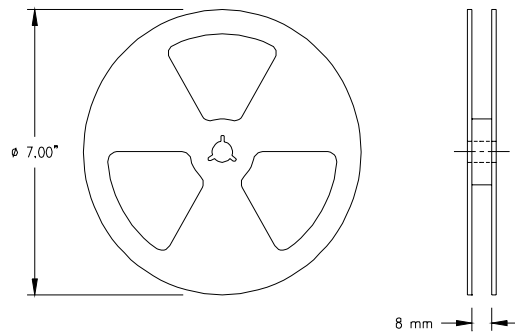


## TSOP-6 Tape & Reel Information



NOTES:

1. OUTLINE CONFORMS TO EIA-481 & EIA-541.



NOTES:

1. OUTLINE CONFORMS TO EIA-481 & EIA-541.

Data and specifications subject to change without notice.  
This product has been designed and qualified for the Consumer market.  
Qualifications Standards can be found on IR's Web site.

International  
**IR** Rectifier

**IR WORLD HEADQUARTERS:** 233 Kansas St., El Segundo, California 90245, USA Tel: (310) 252-7105  
TAC Fax: (310) 252-7903

Visit us at [www.irf.com](http://www.irf.com) for sales contact information.04/2010

# Mouser Electronics

Authorized Distributor

Click to View Pricing, Inventory, Delivery & Lifecycle Information:

[International Rectifier:](#)

[IRF5806TRPBF](#)