

# Protection Device

TVS (Transient Voltage Suppressor)

## ESD101-B1-02 Series

Bi-directional, 5.5 V, 0.1 pF, 0201, 0402, RoHS and Halogen Free compliant

ESD101-B1-02ELS  
ESD101-B1-02EL

## Data Sheet

Revision 1.3, 2015-07-13  
Final

**Edition 2015-07-13**

**Published by**

**Infineon Technologies AG**

**81726 Munich, Germany**

**© 2015 Infineon Technologies AG**

**All Rights Reserved.**

### **Information**

For further information on technology, delivery terms and conditions and prices, please contact the nearest Infineon Technologies Office ([www.infineon.com](http://www.infineon.com))

### **Warnings**

Due to technical requirements, components may contain dangerous substances. For information on the types in question, please contact the nearest Infineon Technologies Office.

Infineon Technologies components may be used in life-support devices or systems only with the express written approval of Infineon Technologies, if a failure of such components can reasonably be expected to cause the failure of that life-support device or system or to affect the safety or effectiveness of that device or system. Life support devices or systems are intended to be implanted in the human body or to support and/or maintain and sustain and/or protect human life. If they fail, it is reasonable to assume that the health of the user or other persons may be endangered.

# 1 Product Overview

## 1.1 Features

- ESD / transient protection of high speed data lines according to:
  - IEC61000-4-2 (ESD):  $\pm 14$  kV (air),  $\pm 12$  kV(contact)
  - IEC61000-4-4 (EFT):  $\pm 1.5$  kV /  $\pm 30$  A (5/50 ns)
  - IEC61000-4-5 (surge):  $\pm 2$  A (8/20  $\mu$ s)
- Bi-directional working voltage up to:  $V_{RWM} = \pm 5.5$  V
- Extremely low capacitance  $C_L = 0.1$  pF (typical) at  $f = 1$  GHz
- Very low clamping voltage:  $V_{CL} = 30$  V (typical) at  $I_{TLP} = 16$  A
- Very low reverse current:  $I_R < 0.1$  nA
- Very low dynamic resistance:  $R_{DYN} = 1.5$   $\Omega$  (typical)
- Pb-free package (RoHS compliant)



## 1.2 Application Examples [3]

- Tailored for ESD Protection of capacitance-susceptible application like
  - Super high speed interface
  - RF antenna

## 1.3 Product Description

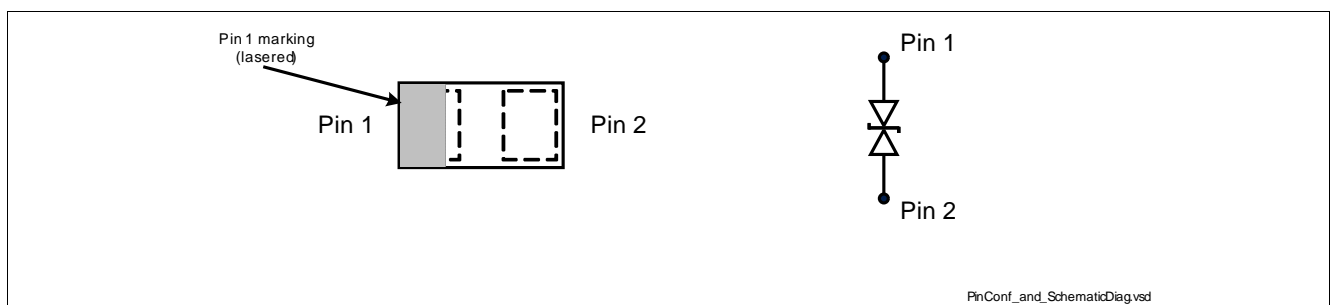

Figure 1 Pin configuration and Schematic diagram

Table 1 Part Information

Type	Package	Configuration	Marking code
ESD101-B1-02ELS	TSSLP-2-4	1 line, bi-directional	<u>R</u>
ESD101-B1-02EL	TSLP-2-20	1 line, bi-directional	R

## 2 Maximum Ratings

**Table 2** Maximum Rating at  $T_A = 25\text{ °C}$ , unless otherwise specified<sup>1)</sup>

Parameter	Symbol	Values	Unit
ESD air discharge <sup>2)</sup>	$V_{ESD}$	$\pm 14$	kV
ESD contact discharge <sup>2)</sup>		$\pm 12$	
Peak pulse power	$P_{PK}$	30	W
Peak pulse current <sup>3)</sup>	$I_{PP}$	$\pm 2$	A
Operating temperature	$T_{OP}$	-55 to 125	°C
Storage temperature	$T_{stg}$	-65 to 150	°C

- 1) Device is electrically symmetrical
- 2)  $V_{ESD}$  according to IEC61000-4-2
- 3) Non-repetitive current pulse 8/20  $\mu$ s exponential decay waveform according to IEC61000-4-5

**Attention:** Stresses above the max. values listed here may cause permanent damage to the device. Exposure to absolute maximum rating conditions for extended periods may affect device reliability. Maximum ratings are absolute ratings; exceeding only one of these values may cause irreversible damage to the integrated circuit.

## 3 Electrical Characteristics at $T_A = 25\text{ °C}$ , unless otherwise specified

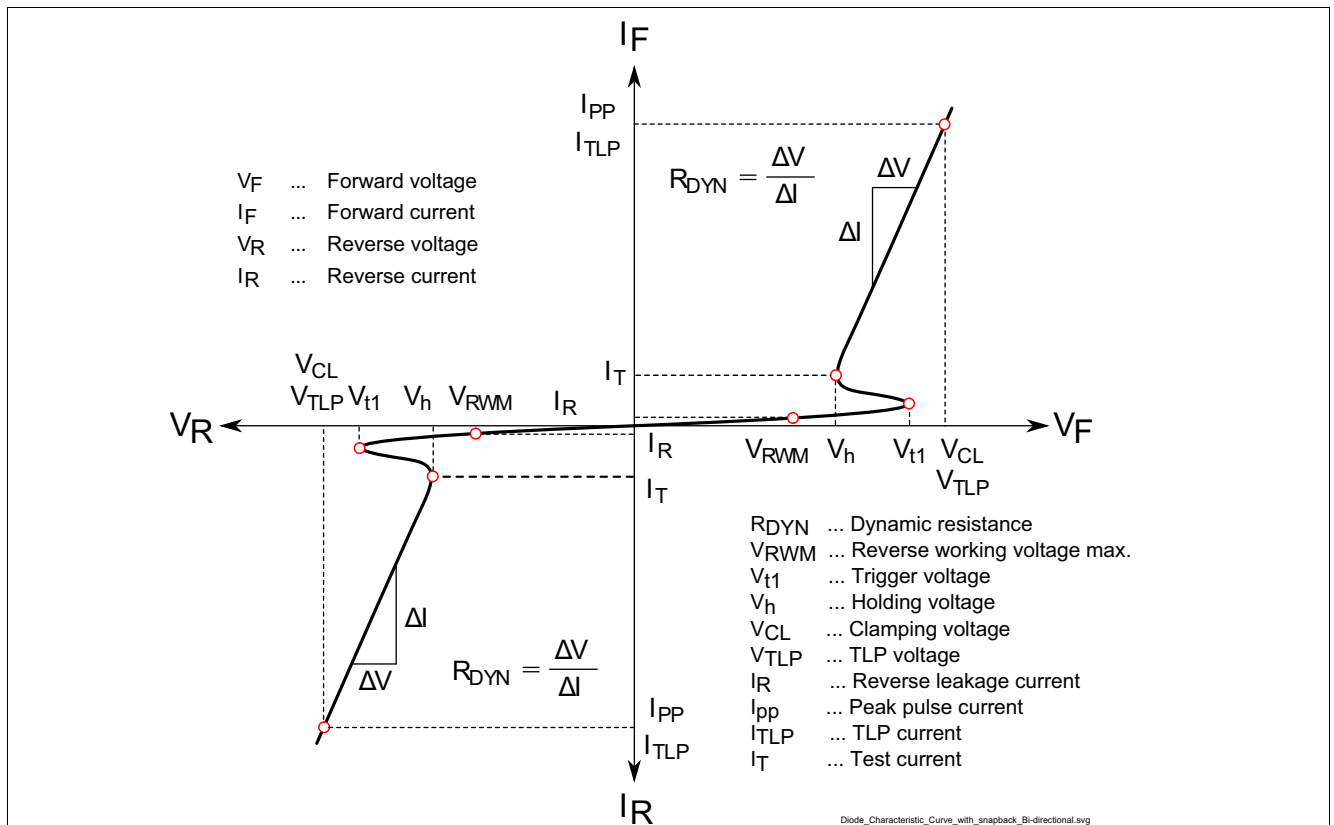

**Figure 2** Definitions of electrical characteristics

**Electrical Characteristics at  $T_A = 25\text{ °C}$ , unless otherwise specified**
**Table 3 DC Characteristics at  $T_A = 25\text{ °C}$ , unless otherwise specified <sup>1)</sup>**

Parameter	Symbol	Values			Unit	Note / Test Condition
		Min.	Typ.	Max.		
Reverse working voltage	$V_{RWM}$	-5.5	–	5.5	V	
Trigger voltage	$V_{t1}$	6.1	–	–		
Holding voltage	$V_h$	6.1	7.0	7.9		$I_T = 10\text{ mA}$
Reverse leakage current	$I_R$	–	<0.1	20	nA	$V_R = 5.5\text{ V}$

1) Device is electrically symmetrical

**Table 4 AC Characteristics at  $T_A = 25\text{ °C}$ , unless otherwise specified**

Parameter	Symbol	Values			Unit	Note / Test Condition
		Min.	Typ.	Max.		
Line capacitance	$C_L$	–	–	0.2	pF	$V_R = 0\text{ V}, f = 1\text{ MHz}$
		–	0.1	–		$V_R = 0\text{ V}, f = 1\text{ GHz}$
Serie inductance	$L_S$	–	0.2	–	nH	ESD101-B1-02ELS ESD101-B1-02EL
		–	0.4	–		

**Table 5 ESD and Surge Characteristics at  $T_A = 25\text{ °C}$ , unless otherwise specified <sup>1)</sup>**

Parameter	Symbol	Values			Unit	Note / Test Condition
		Min.	Typ.	Max.		
Clamping voltage <sup>2)</sup>	$V_{CL}$	–	18	–	V	$I_{TLP} = 8\text{ A}, t_p = 100\text{ ns}$
		–	30	–		$I_{TLP} = 16\text{ A}, t_p = 100\text{ ns}$
Clamping voltage <sup>3)</sup>		–	9	–		$I_{PP} = 1\text{ A}, t_p = 8/20\text{ }\mu\text{s}$
		–	13	–		$I_{PP} = 2\text{ A}, t_p = 8/20\text{ }\mu\text{s}$
Dynamic resistance <sup>2)</sup>	$R_{DYN}$	–	1.5	–	$\Omega$	$t_p = 100\text{ ns}$

1) Device is electrically symmetrical

2) Please refer to Application Note AN210[1]. TLP parameter:  $Z_0 = 50\text{ }\Omega$ ,  $t_p = 100\text{ ns}$ ,  $t_r = 300\text{ ps}$ .

3) Non-repetitive current pulse 8/20 $\mu\text{s}$  exponential decay waveform according to IEC61000-4-5

## 4 Typical Characteristics Diagrams

Typical characteristics diagrams at  $T_A = 25^\circ\text{C}$ , unless otherwise specified

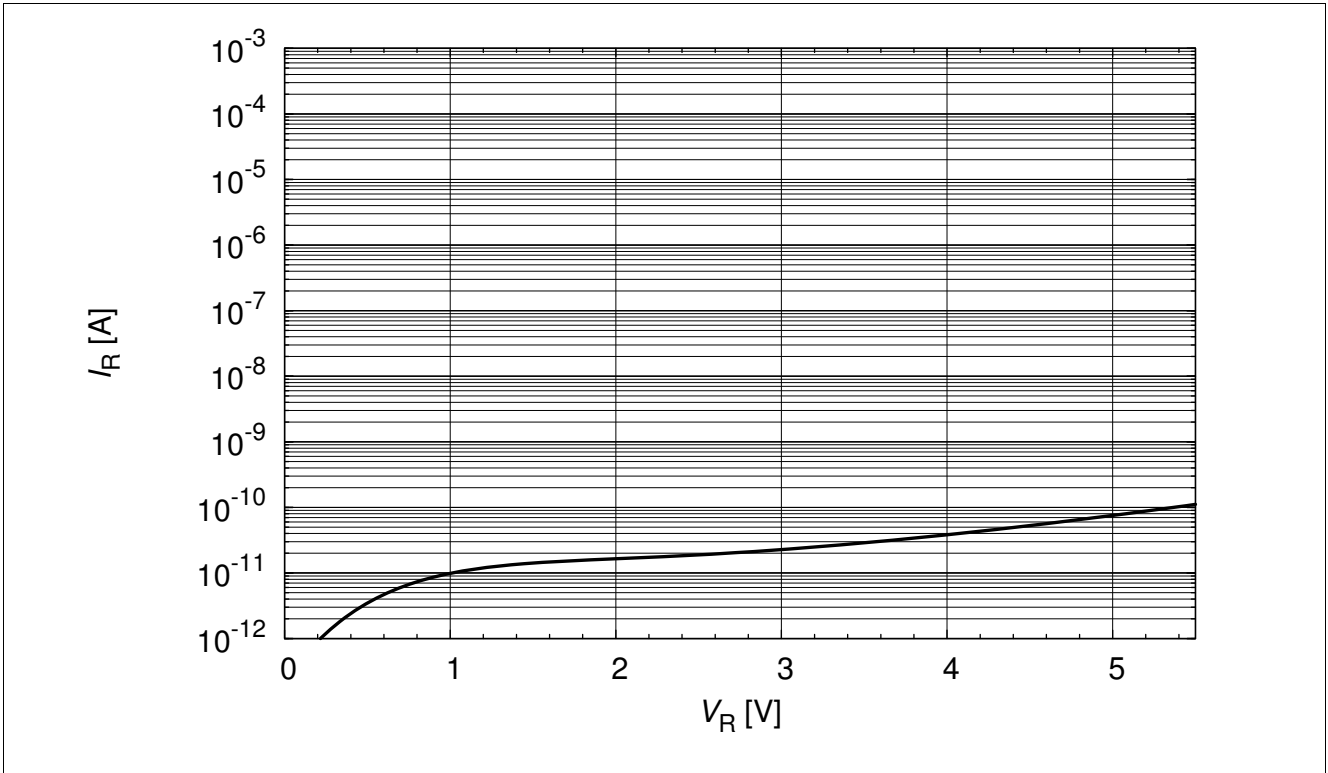

Figure 3 Reverse leakage current:  $I_R = f(V_R)$

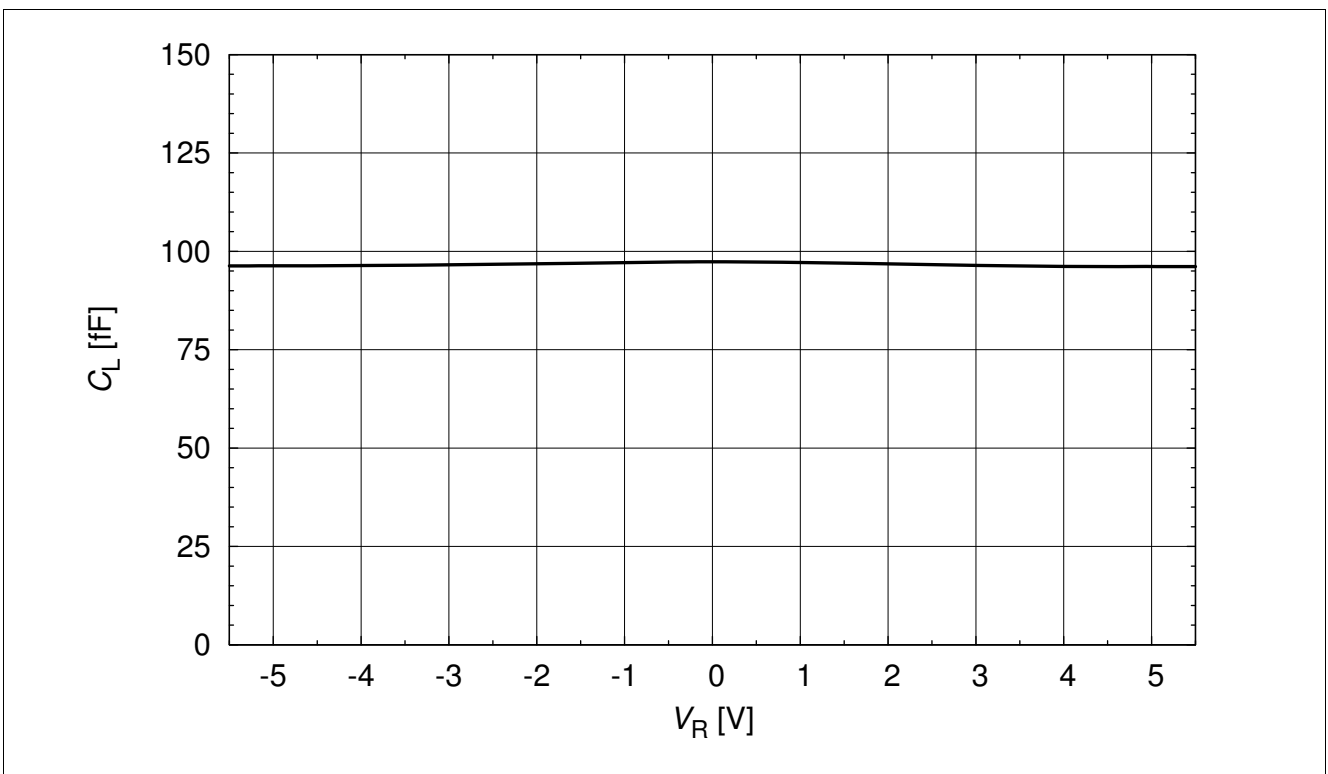

Figure 4 Line capacitance  $C_L = f(V_R), f = 1 \text{ GHz}$

Typical Characteristics Diagrams

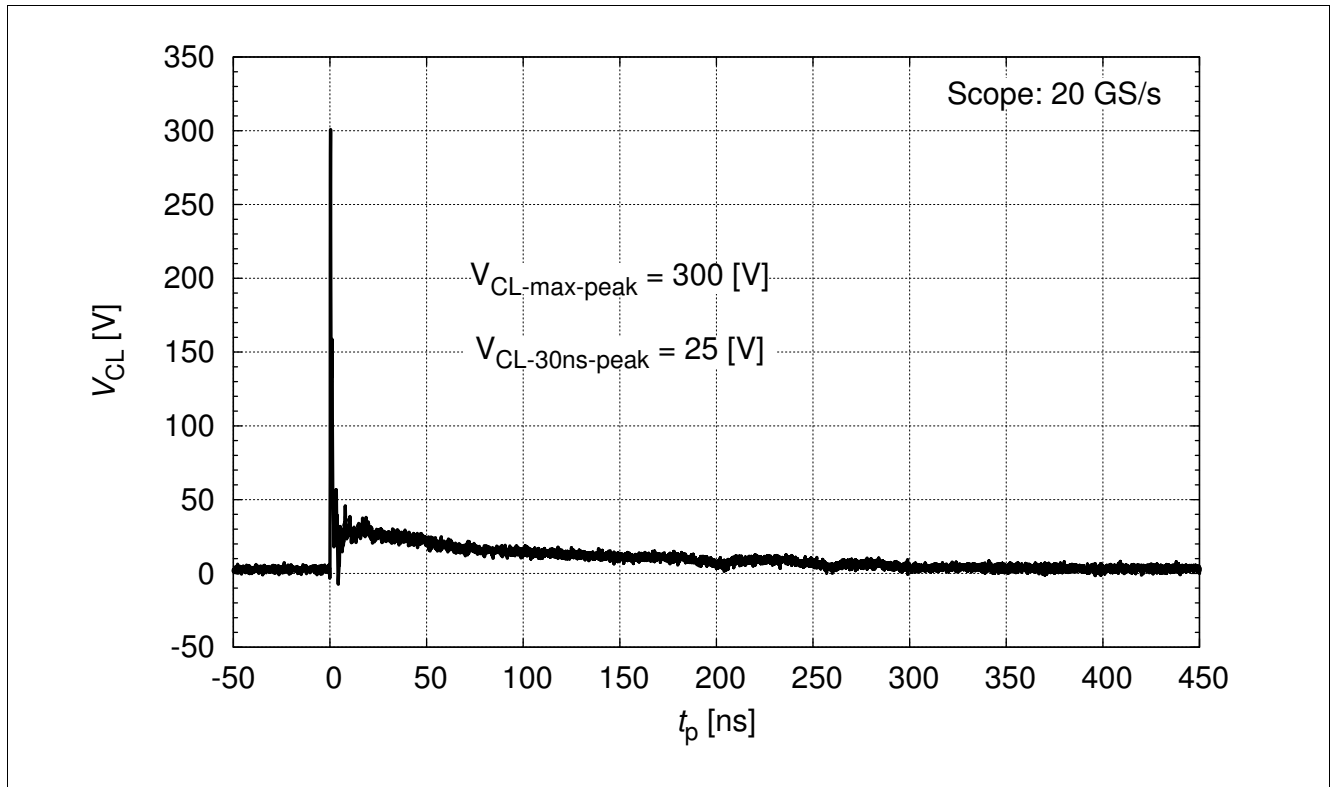

Figure 5 Clamping voltage (ESD):  $V_{CL} = f(t)$ , 8 kV positive pulse from pin 1 to pin 2

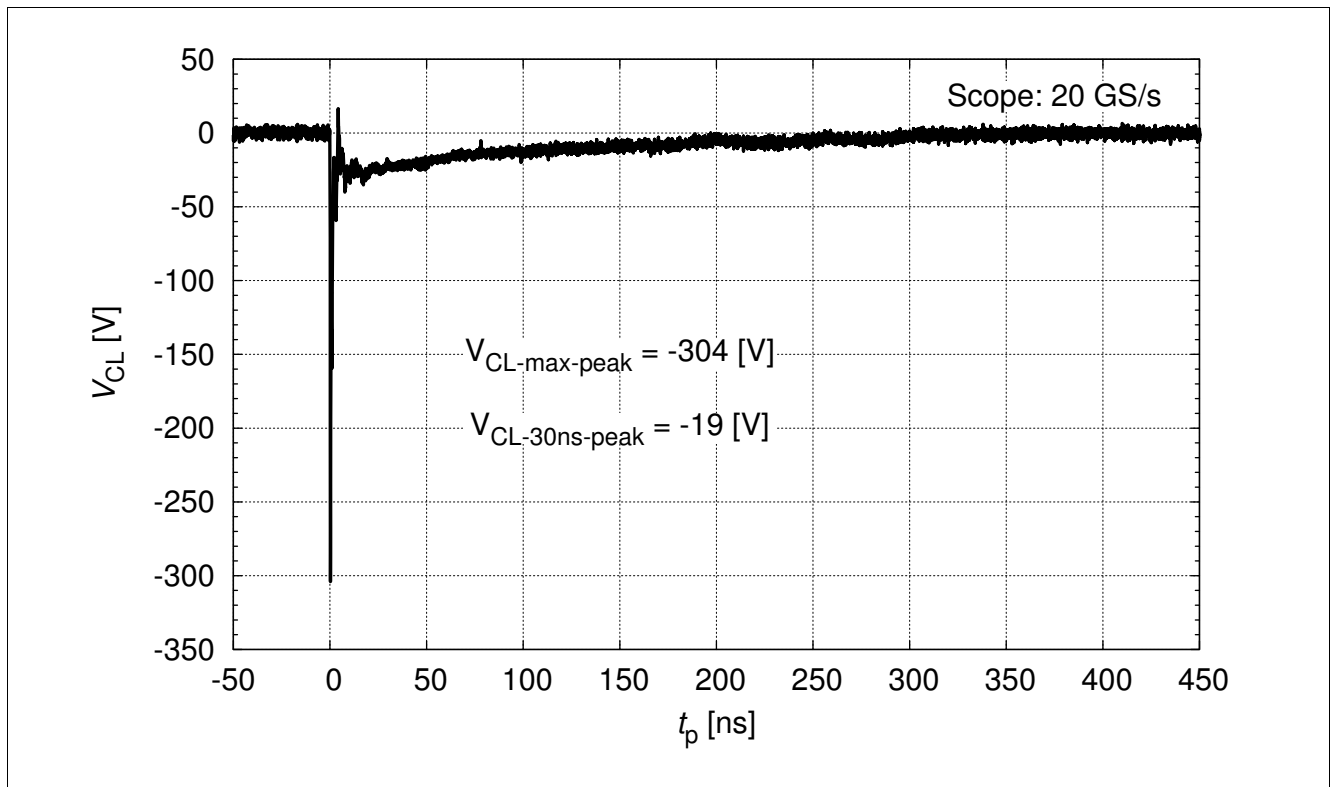

Figure 6 Clamping voltage (ESD):  $V_{CL} = f(t)$ , 8 kV negative pulse from pin 1 to pin 2

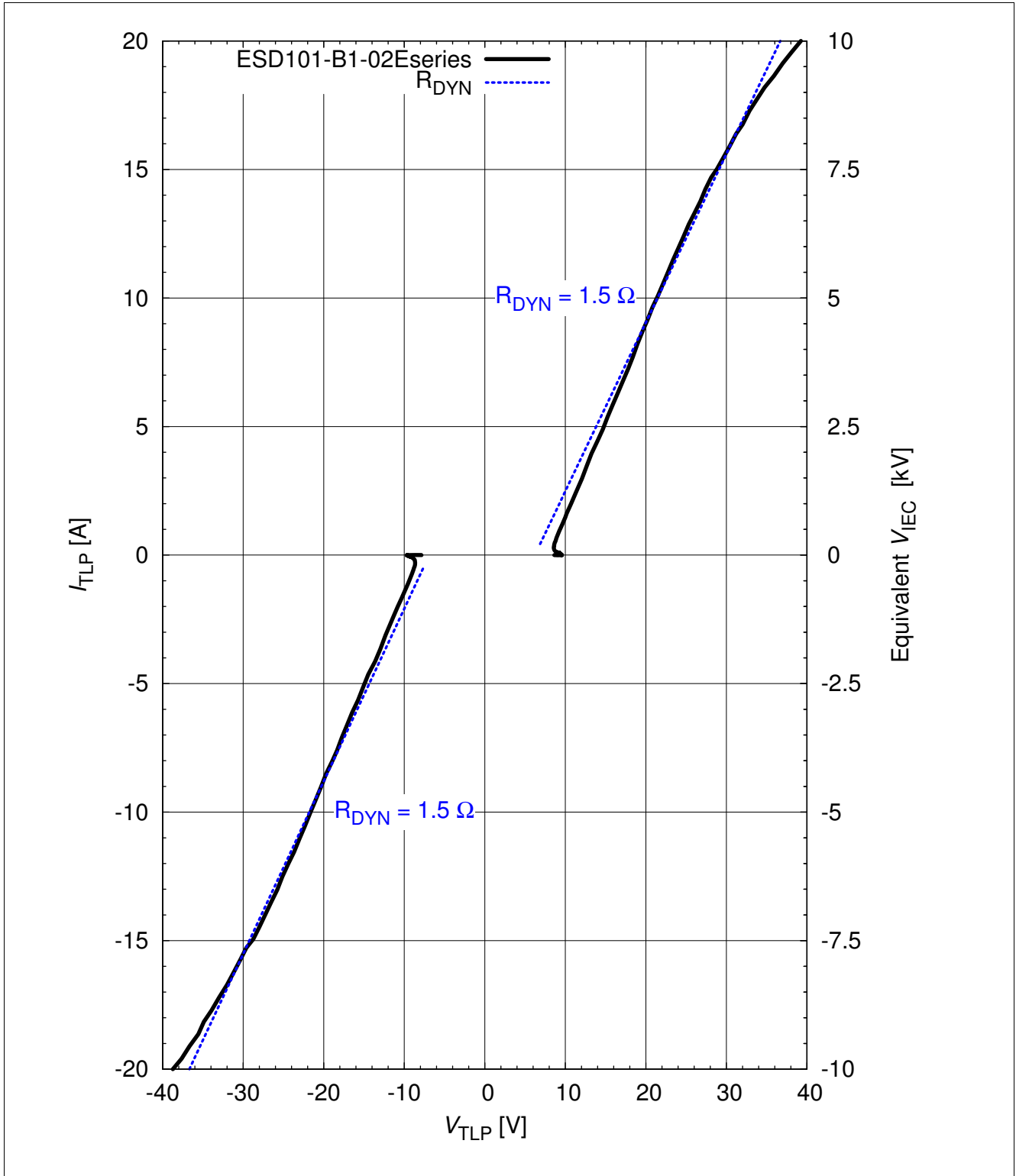

Figure 7 Clamping voltage (TLP):  $I_{TLP} = f(V_{TLP})$  [1], pin 1 to pin 2



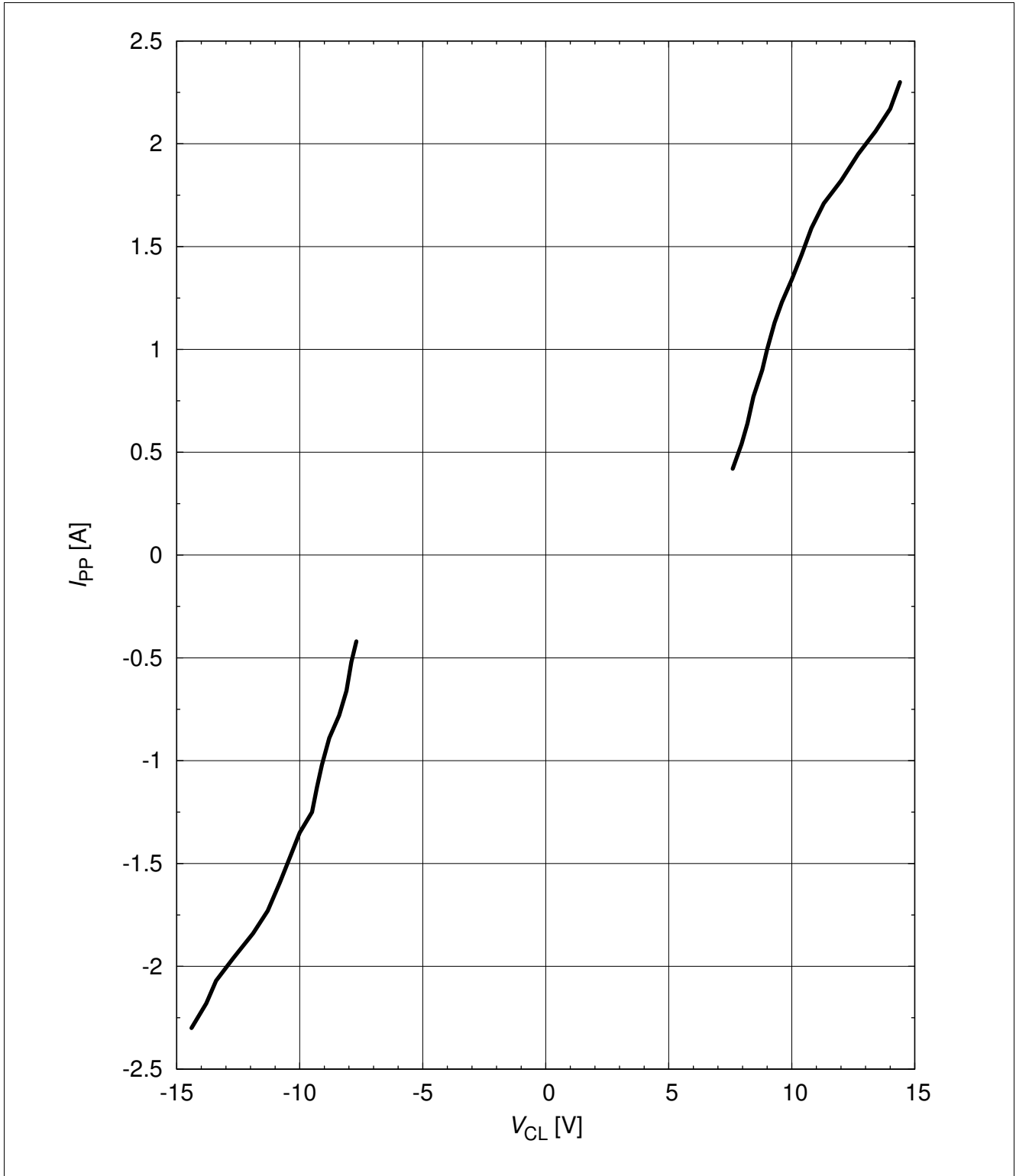

Figure 8 Clamping voltage (Surge):  $I_{PP} = f(V_{CL})$  [1], pin 1 to pin 2

Typical Characteristics Diagrams

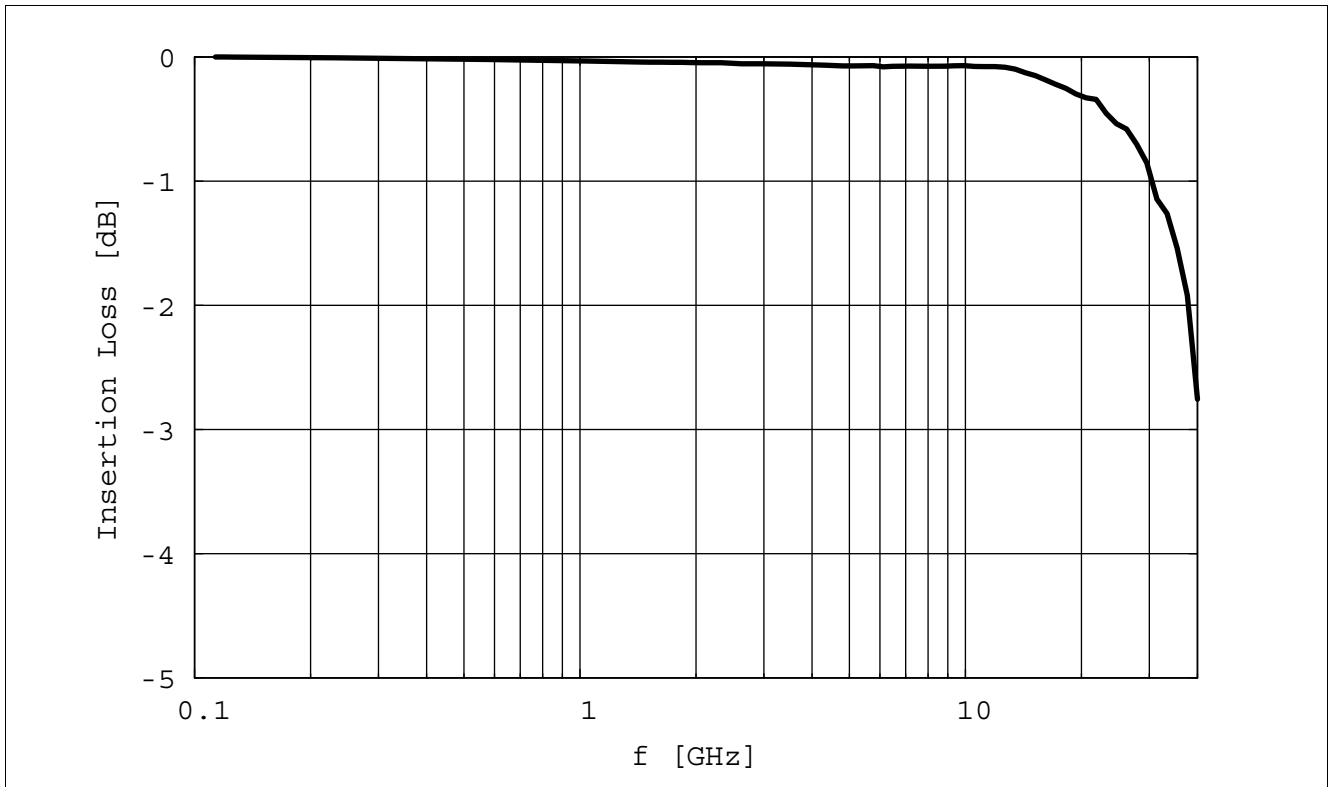

Figure 9 Insertion loss vs. frequency in a 50 Ω system (ESD101-B1-02ELS)

## 5 Package Information

### 5.1 TSSLP-2-4

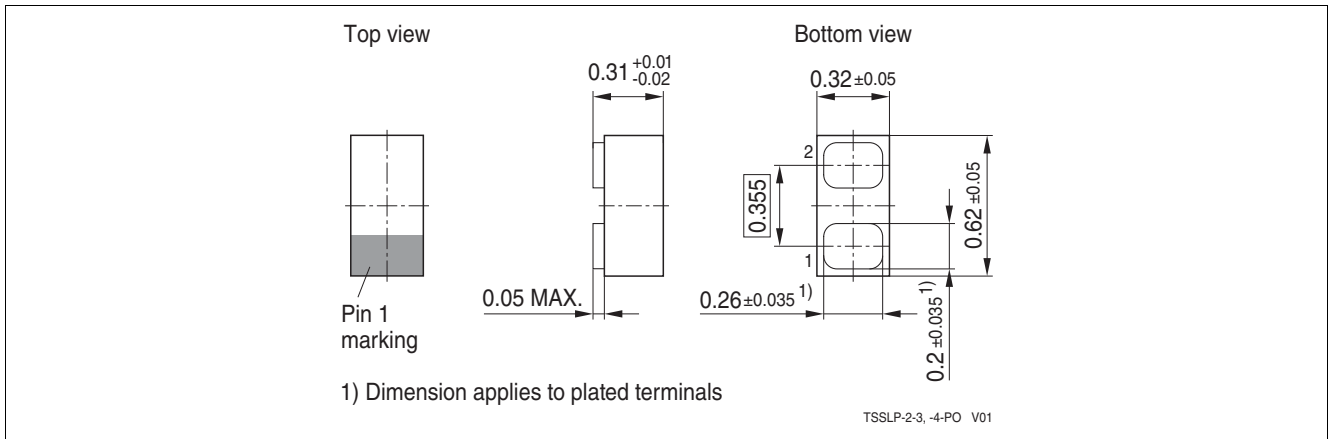

Figure 10 TSSLP-2-4 Package outline (dimension in mm)

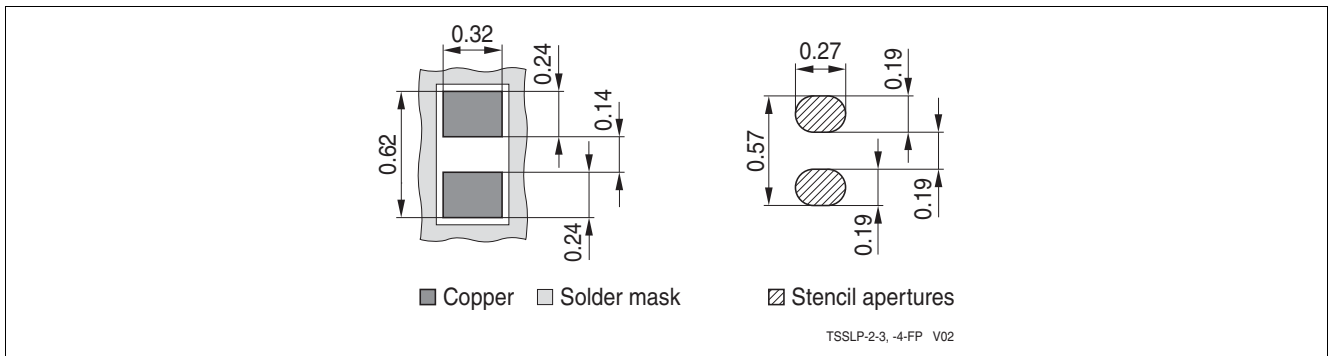

Figure 11 TSSLP-2-4 Footprint (dimension in mm)

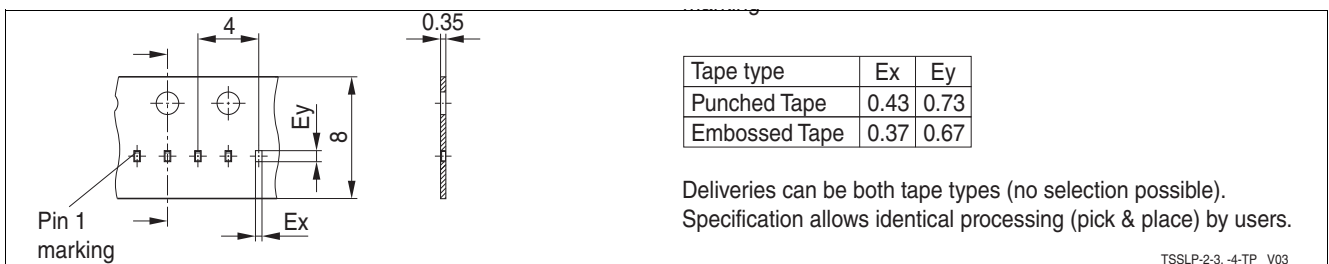

Figure 12 TSSLP-2-4 Packing (dimension in mm)

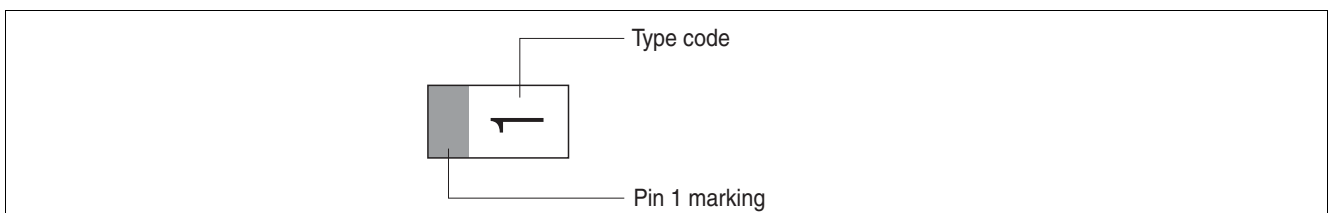

Figure 13 TSSLP-2-4 Marking example [Table 1 "Part Information" on Page 3](#)

5.2 TSLP-2-20

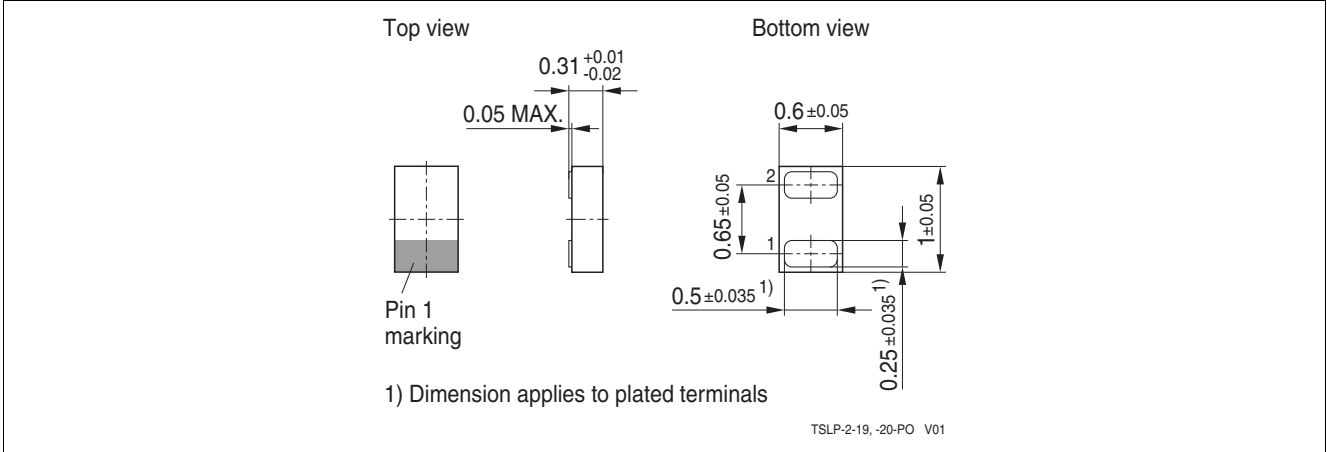

Figure 14 TSLP-2-20 Package outline (dimension in mm)

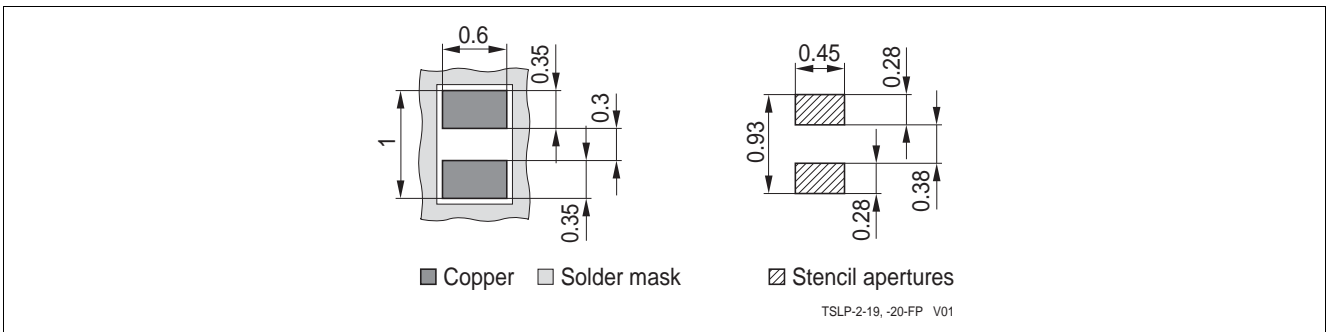

Figure 15 TSLP-2-20 Footprint (dimension in mm)

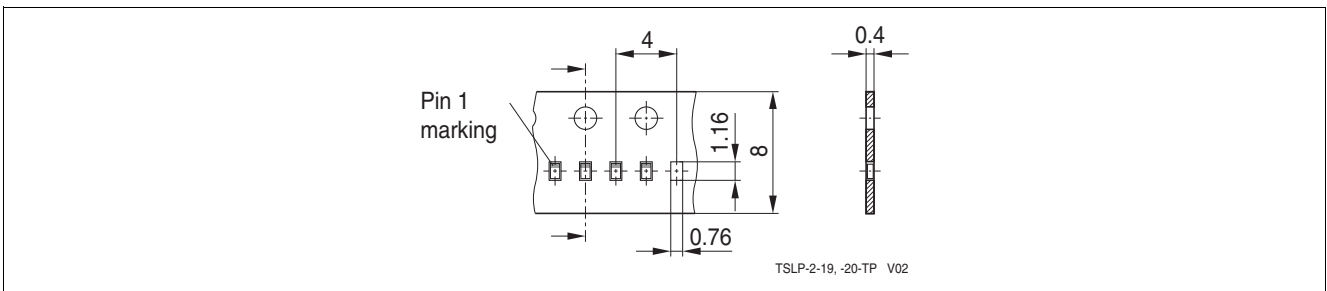

Figure 16 TSLP-2-20 Packing (dimension in mm)

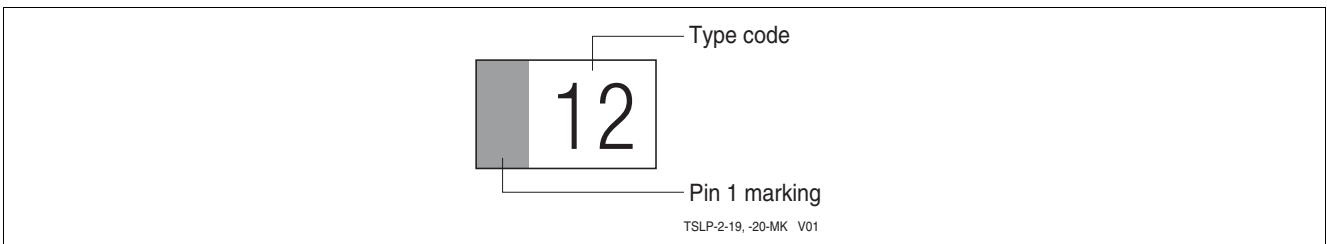

Figure 17 TSLP-2-20 Marking example [Table 1 “Part Information” on Page 3](#)

**References**

- [1] Infineon Technologies AG, "Effective ESD Protection Design at System Level Using VF-TLP Characterization Methodology", **Application Note AN210**, RF and Protection Devices, April 22, 2010, Rev.1.0
- [2] Infineon AG - Recommendations for PCB Assembly of Infineon TSLP and TSSLP Packages
- [3] Infineon AC - **Application Note AN327**: ESD101-B1 / ESD103-B1, Bi-directional Ultra Low Capacitance Transient Voltage Suppression Diodes for High Power RF Applications.

**Revision History: Rev. .1.2, 2013-07-23**

Page or Item	Subjects (major changes since previous revision)
<b>Revision 1.3, 2015-07-13</b>	
All	Layout changes
5	Table 3-1) updated

**Trademarks of Infineon Technologies AG**

AURIX™, BlueMoon™, COMNEON™, C166™, CROSSAVE™, CanPAK™, CIPOS™, CoolMOS™, CoolSET™, CORECONTROL™, DAVE™, EasyPIM™, EconoBRIDGE™, EconoDUAL™, EconoPACK™, EconoPIM™, EiceDRIVER™, EUPEC™, FCOS™, HITFET™, HybridPACK™, ISOFACE™, I<sup>2</sup>RF™, IsoPACK™, MIPAQ™, ModSTACK™, my-d™, NovalithIC™, OmniTune™, OptiMOS™, ORIGA™, PROFET™, PRO-SIL™, PRIMARION™, PrimePACK™, RASIC™, ReverSave™, SatRIC™, SIEGET™, SINDRION™, SMARTi™, SmartLEWIS™, TEMPFET™, thinQ!™, TriCore™, TRENCHSTOP™, X-GOLD™, XMM™, X-PMU™, XPOSSYS™.

**Other Trademarks**

Advance Design System™ (ADS) of Agilent Technologies, AMBA™, ARM™, MULTI-ICE™, PRIMECELL™, REALVIEW™, THUMB™ of ARM Limited, UK. AUTOSAR™ is licensed by AUTOSAR development partnership. Bluetooth™ of Bluetooth SIG Inc. CAT-iq™ of DECT Forum. COLOSSUS™, FirstGPS™ of Trimble Navigation Ltd. EMV™ of EMVCo, LLC (Visa Holdings Inc.). EPCOS™ of Epcos AG. FLEXGO™ of Microsoft Corporation. FlexRay™ is licensed by FlexRay Consortium. HYPERTERMINAL™ of Hilgraeve Incorporated. IEC™ of Commission Electrotechnique Internationale. IrDA™ of Infrared Data Association Corporation. ISO™ of INTERNATIONAL ORGANIZATION FOR STANDARDIZATION. MATLAB™ of MathWorks, Inc. MAXIM™ of Maxim Integrated Products, Inc. MICROTEC™, NUCLEUS™ of Mentor Graphics Corporation. Mifare™ of NXP. MIPI™ of MIPI Alliance, Inc. MIPS™ of MIPS Technologies, Inc., USA. muRata™ of MURATA MANUFACTURING CO., MICROWAVE OFFICE™ (MWO) of Applied Wave Research Inc., OmniVision™ of OmniVision Technologies, Inc. Openwave™ Openwave Systems Inc. RED HAT™ Red Hat, Inc. RFMD™ RF Micro Devices, Inc. SIRIUS™ of Sirius Sattelite Radio Inc. SOLARIS™ of Sun Microsystems, Inc. SPANSION™ of Spansion LLC Ltd. Symbian™ of Symbian Software Limited. TAIYO YUDEN™ of Taiyo Yuden Co. TEAKLITE™ of CEVA, Inc. TEKTRONIX™ of Tektronix Inc. TOKO™ of TOKO KABUSHIKI KAISHA TA. UNIX™ of X/Open Company Limited. VERILOG™, PALLADIUM™ of Cadence Design Systems, Inc. VLYNQ™ of Texas Instruments Incorporated. VXWORKS™, WIND RIVER™ of WIND RIVER SYSTEMS, INC. ZETEX™ of Diodes Zetex Limited.

Last Trademarks Update 2010-06-09

[www.infineon.com](http://www.infineon.com)

Published by Infineon Technologies AG

# Mouser Electronics

Authorized Distributor

Click to View Pricing, Inventory, Delivery & Lifecycle Information:

[Infineon:](#)

[ESD101B102ELE6327XTMA1](#) [ESD101B102ELSE6327XTSA1](#)