

IRF7324PbF

HEXFET® Power MOSFET

- Trench Technology
- Ultra Low On-Resistance
- Dual P-Channel MOSFET
- Low Profile (<1.1mm)
- Available in Tape & Reel
- 2.5V Rated
- Lead-Free

Description

New trench HEXFET® Power MOSFETs from International Rectifier utilize advanced processing techniques to achieve extremely low on-resistance per silicon area. This benefit, combined with the ruggedized device design that HEXFET power MOSFETs are well known for, provides the designer with an extremely efficient and reliable device for use in battery and load management applications.

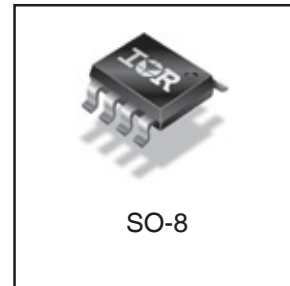
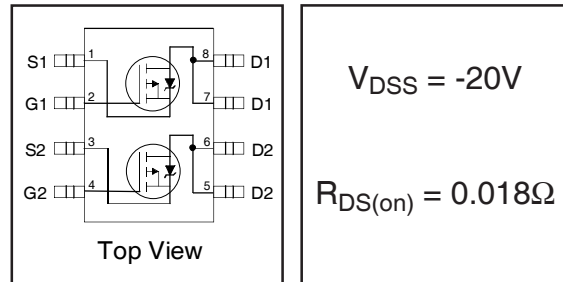

Absolute Maximum Ratings

| | Parameter | Max. | Units |
|--------------------------|--|--------------|-------|
| V_{DS} | Drain-Source Voltage | -20 | V |
| $I_D @ T_A = 25^\circ C$ | Continuous Drain Current, $V_{GS} @ -4.5V$ | -9.0 | A |
| $I_D @ T_A = 70^\circ C$ | Continuous Drain Current, $V_{GS} @ -4.5V$ | -7.1 | |
| I_{DM} | Pulsed Drain Current ^① | -71 | |
| $P_D @ T_A = 25^\circ C$ | Maximum Power Dissipation ^③ | 2.0 | W |
| $P_D @ T_A = 70^\circ C$ | Maximum Power Dissipation ^③ | 1.3 | W |
| | Linear Derating Factor | 16 | mW/°C |
| V_{GS} | Gate-to-Source Voltage | ± 12 | V |
| T_J, T_{STG} | Junction and Storage Temperature Range | -55 to + 150 | °C |

Thermal Resistance

| | Parameter | Max. | Units |
|-----------------|--|------|-------|
| $R_{\theta JA}$ | Maximum Junction-to-Ambient ^③ | 62.5 | °C/W |

Electrical Characteristics @ $T_J = 25^\circ\text{C}$ (unless otherwise specified)

| | Parameter | Min. | Typ. | Max. | Units | Conditions |
|---------------------------------|--------------------------------------|-------|-------|-------|----------|---|
| $V_{(BR)DSS}$ | Drain-to-Source Breakdown Voltage | -20 | — | — | V | $V_{GS} = 0V, I_D = -250\mu A$ |
| $\Delta V_{(BR)DSS}/\Delta T_J$ | Breakdown Voltage Temp. Coefficient | — | -0.02 | — | V/°C | Reference to $25^\circ\text{C}, I_D = -1\text{mA}$ |
| $R_{DS(on)}$ | Static Drain-to-Source On-Resistance | — | — | 0.018 | Ω | $V_{GS} = -4.5V, I_D = -9.0A$ ② |
| | | — | — | 0.026 | | $V_{GS} = -2.5V, I_D = -7.7A$ ② |
| $V_{GS(th)}$ | Gate Threshold Voltage | -0.45 | — | -1.0 | V | $V_{DS} = V_{GS}, I_D = -250\mu A$ |
| g_{fs} | Forward Transconductance | 19 | — | — | S | $V_{DS} = -10V, I_D = -9.0A$ |
| I_{DSS} | Drain-to-Source Leakage Current | — | — | -1.0 | μA | $V_{DS} = -16V, V_{GS} = 0V$ |
| | | — | — | -25 | | $V_{DS} = -16V, V_{GS} = 0V, T_J = 125^\circ\text{C}$ |
| I_{GSS} | Gate-to-Source Forward Leakage | — | — | -100 | nA | $V_{GS} = -12V$ |
| | Gate-to-Source Reverse Leakage | — | — | 100 | | $V_{GS} = 12V$ |
| Q_g | Total Gate Charge | — | 42 | 63 | nC | $I_D = -9.0A$ |
| Q_{gs} | Gate-to-Source Charge | — | 7.1 | 11 | | $V_{DS} = -16V$ |
| Q_{gd} | Gate-to-Drain ("Miller") Charge | — | 12 | 18 | | $V_{GS} = -5.0V$ |
| $t_{d(on)}$ | Turn-On Delay Time | — | 17 | — | ns | $V_{DD} = -10V$ |
| t_r | Rise Time | — | 36 | — | | $I_D = -1.0A$ |
| $t_{d(off)}$ | Turn-Off Delay Time | — | 170 | — | | $R_G = 6.0\Omega$ |
| t_f | Fall Time | — | 190 | — | | $R_D = 10\Omega$ ② |
| C_{iss} | Input Capacitance | — | 2940 | — | pF | $V_{GS} = 0V$ |
| C_{oss} | Output Capacitance | — | 630 | — | | $V_{DS} = -15V$ |
| C_{rss} | Reverse Transfer Capacitance | — | 420 | — | | $f = 1.0\text{MHz}$ |

Source-Drain Ratings and Characteristics

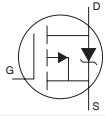
| | Parameter | Min. | Typ. | Max. | Units | Conditions |
|----------|---|------|------|------|-------|--|
| I_S | Continuous Source Current (Body Diode) | — | — | -2.0 | A | MOSFET symbol showing the integral reverse p-n junction diode.  |
| I_{SM} | Pulsed Source Current (Body Diode) ① | — | — | -7.1 | | |
| V_{SD} | Diode Forward Voltage | — | — | -1.2 | V | $T_J = 25^\circ\text{C}, I_S = -2.0A, V_{GS} = 0V$ ② |
| t_{rr} | Reverse Recovery Time | — | 180 | 270 | ns | $T_J = 25^\circ\text{C}, I_F = -2.0A$ |
| Q_{rr} | Reverse Recovery Charge | — | 300 | 450 | nC | $di/dt = -100A/\mu s$ ② |

Notes:

- ① Repetitive rating; pulse width limited by max. junction temperature.
- ② Pulse width $\leq 300\mu s$; duty cycle $\leq 2\%$.
- ③ Surface mounted on FR-4 board, $t \leq 10\text{sec}$.

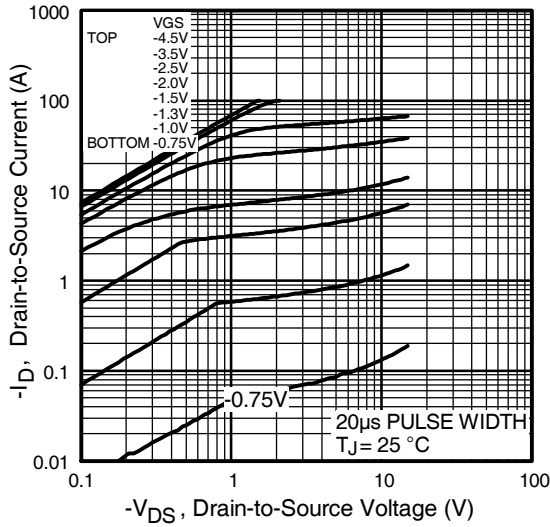

Fig 1. Typical Output Characteristics

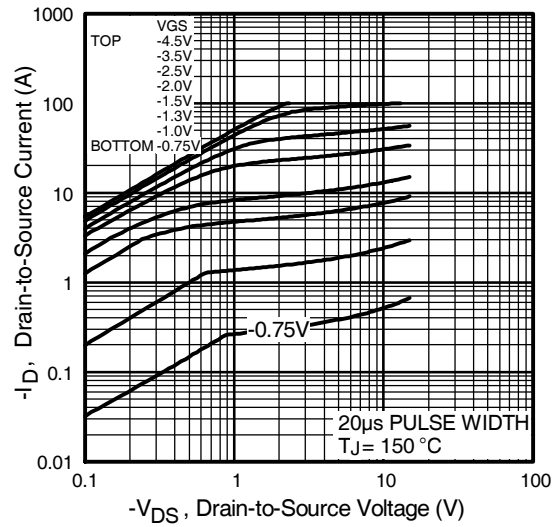

Fig 2. Typical Output Characteristics

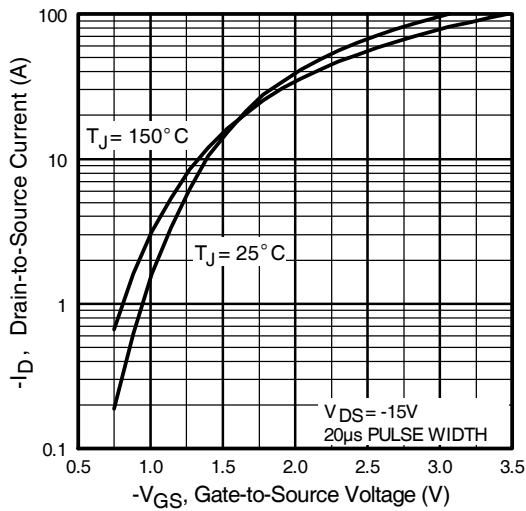

Fig 3. Typical Transfer Characteristics

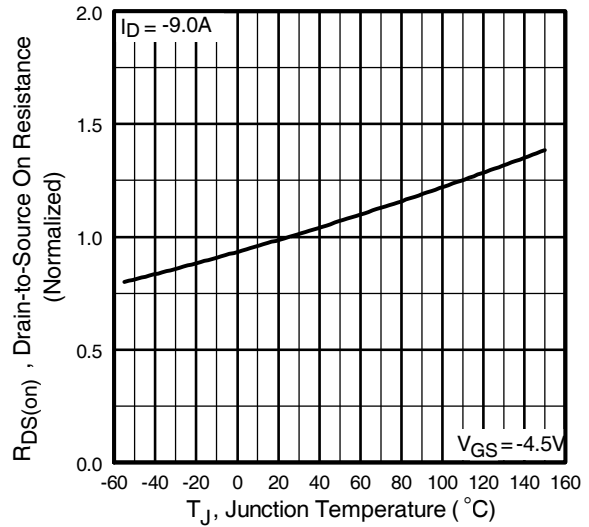

Fig 4. Normalized On-Resistance Vs. Temperature

IRF7324PbF

International
IR Rectifier

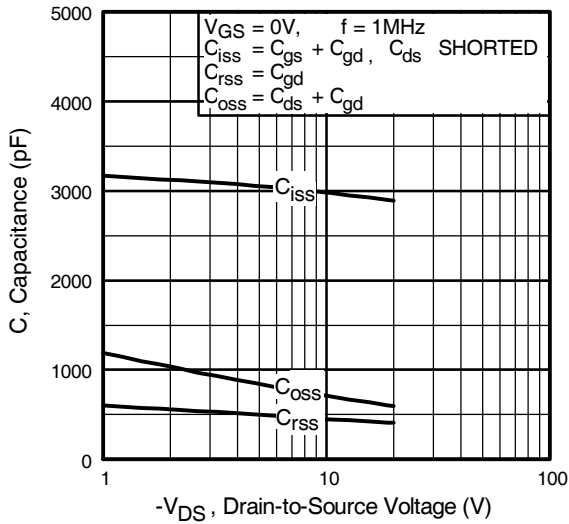

Fig 5. Typical Capacitance Vs. Drain-to-Source Voltage

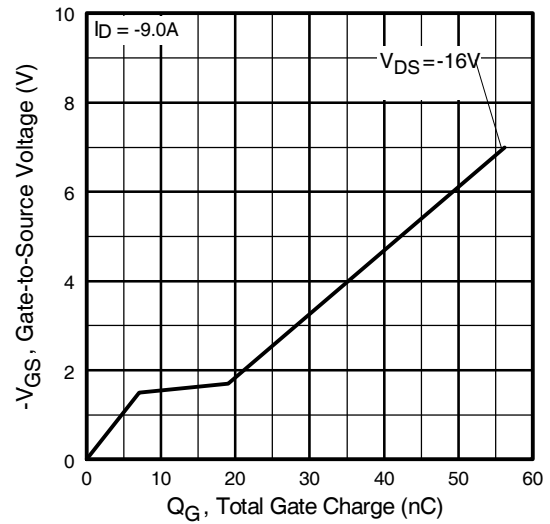

Fig 6. Typical Gate Charge Vs. Gate-to-Source Voltage

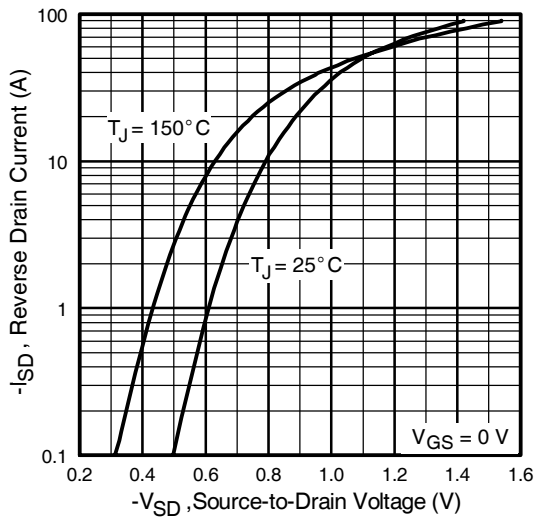

Fig 7. Typical Source-Drain Diode Forward Voltage

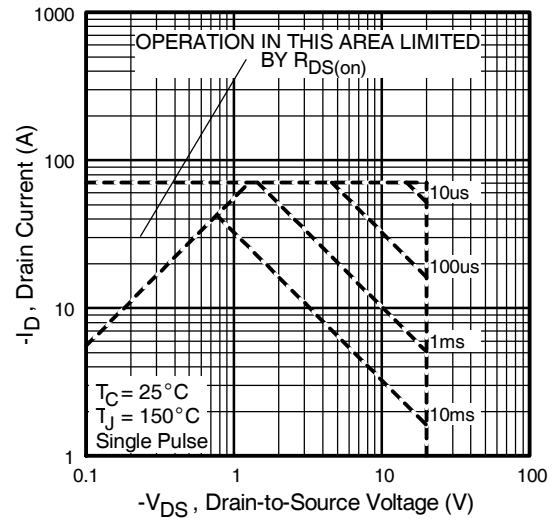

Fig 8. Maximum Safe Operating Area

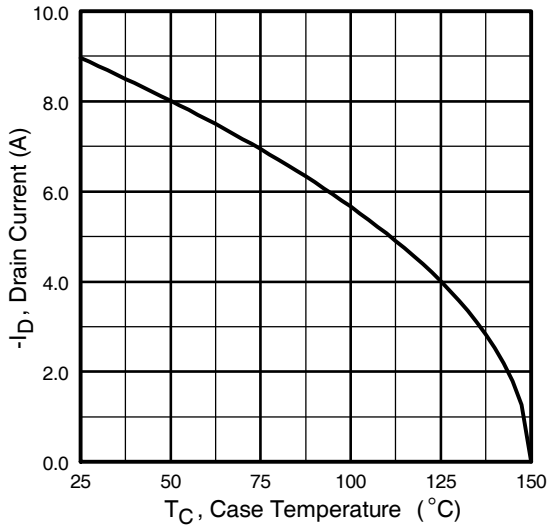

Fig 9. Maximum Drain Current Vs. Case Temperature

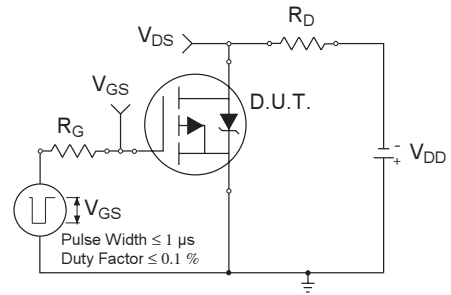

Fig 10a. Switching Time Test Circuit

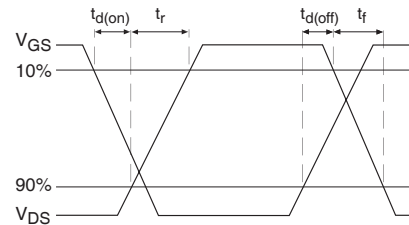

Fig 10b. Switching Time Waveforms

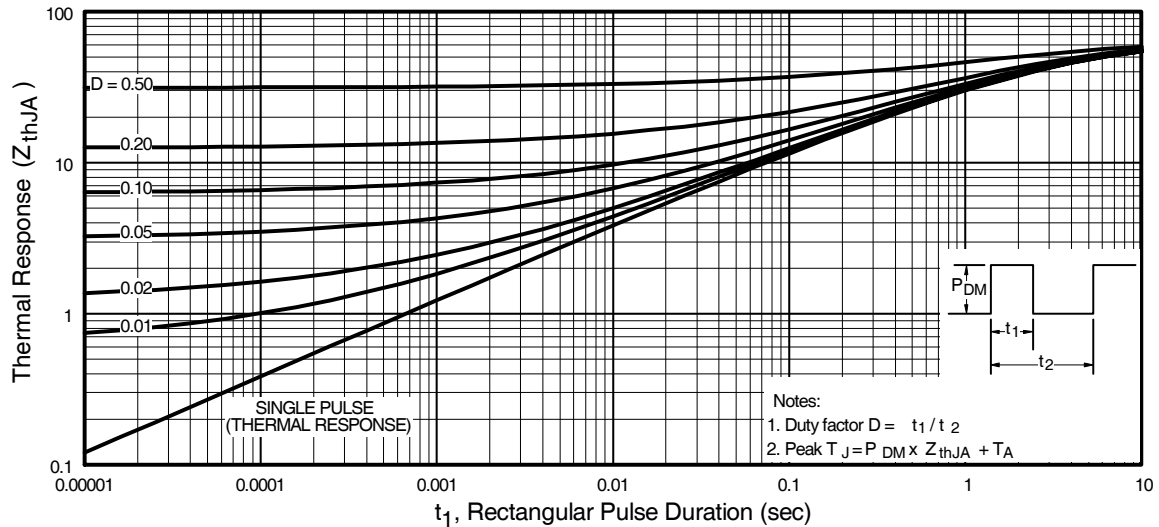

Fig 11. Maximum Effective Transient Thermal Impedance, Junction-to-Ambient

IRF7324PbF

International
IR Rectifier

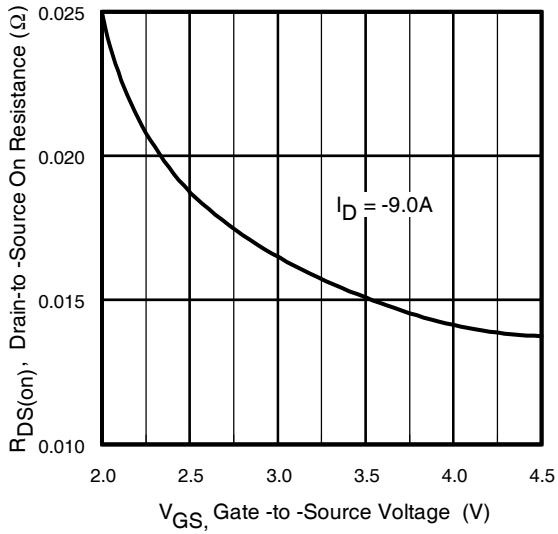

Fig 12. Typical On-Resistance Vs. Gate Voltage

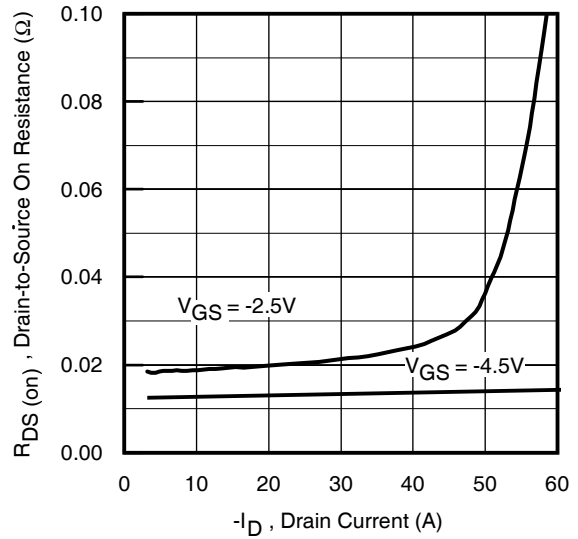

Fig 13. Typical On-Resistance Vs. Drain Current

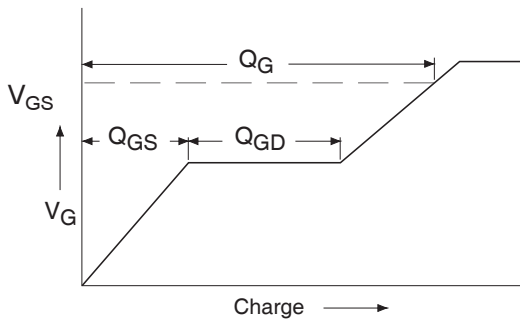

Fig 14a. Basic Gate Charge Waveform

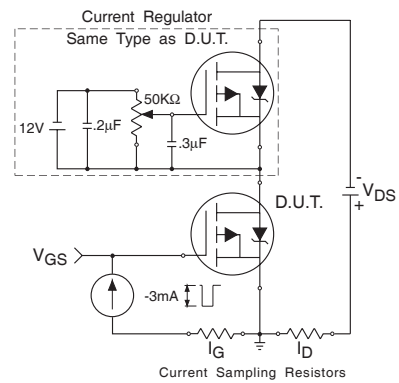
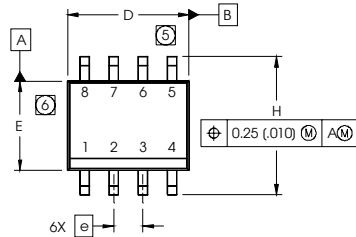

Fig 14b. Gate Charge Test Circuit

SO-8 Package Outline

Dimensions are shown in millimeters (inches)



| DIM | INCHES | | MILLIMETERS | |
|-----|------------|-------|-------------|------|
| | MIN | MAX | MIN | MAX |
| A | .0532 | .0688 | 1.35 | 1.75 |
| A1 | .0040 | .0098 | 0.10 | 0.25 |
| b | .013 | .020 | 0.33 | 0.51 |
| c | .0075 | .0098 | 0.19 | 0.25 |
| D | .189 | .1968 | 4.80 | 5.00 |
| E | .1497 | .1574 | 3.80 | 4.00 |
| e | .050 BASIC | | 1.27 BASIC | |
| e1 | .025 BASIC | | 0.635 BASIC | |
| H | .2284 | .2440 | 5.80 | 6.20 |
| K | .0099 | .0196 | 0.25 | 0.50 |
| L | .016 | .050 | 0.40 | 1.27 |
| y | 0° | 8° | 0° | 8° |

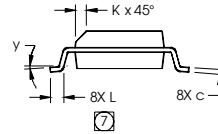
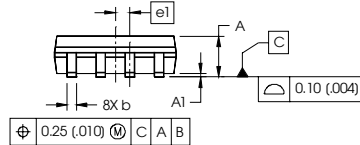

NOTES:

1. DIMENSIONING & TOLERANCING PER ASME Y14.5M-1994.
2. CONTROLLING DIMENSION: MILLIMETER
3. DIMENSIONS ARE SHOWN IN MILLIMETERS (INCHES).
4. OUTLINE CONFORMS TO JEDEC OUTLINE MS-012AA.
5. DIMENSION DOES NOT INCLUDE MOLD PROTRUSIONS. MOLD PROTRUSIONS NOT TO EXCEED 0.15 (.006).
6. DIMENSION DOES NOT INCLUDE MOLD PROTRUSIONS. MOLD PROTRUSIONS NOT TO EXCEED 0.25 (.010).
7. DIMENSION IS THE LENGTH OF LEAD FOR SOLDERING TO A SUBSTRATE.

FOOTPRINT

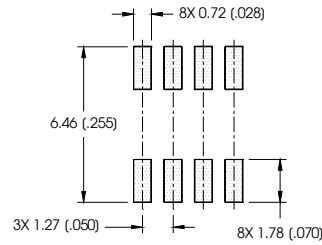

SO-8 Part Marking Information (Lead-Free)

EXAMPLE: THIS IS AN IRF7101 (MOSFET)

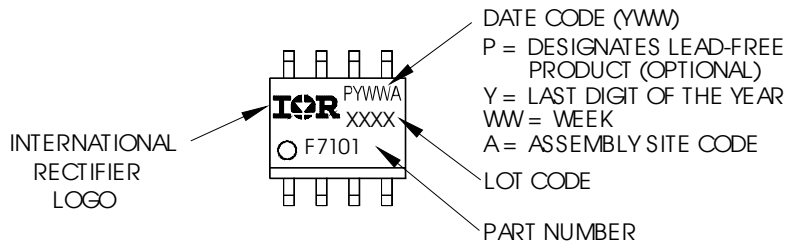

IRF7324PbF

International
IR Rectifier

SO-8 Tape and Reel

Dimensions are shown in millimeters (inches)

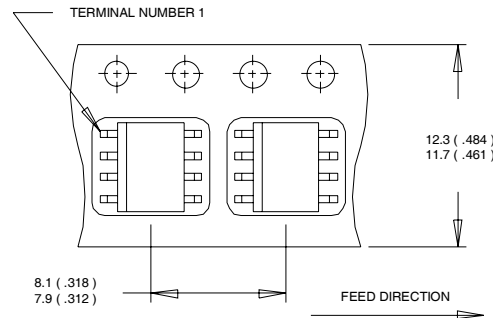

NOTES:

1. CONTROLLING DIMENSION : MILLIMETER.
2. ALL DIMENSIONS ARE SHOWN IN MILLIMETERS(INCHES).
3. OUTLINE CONFORMS TO EIA-481 & EIA-541.

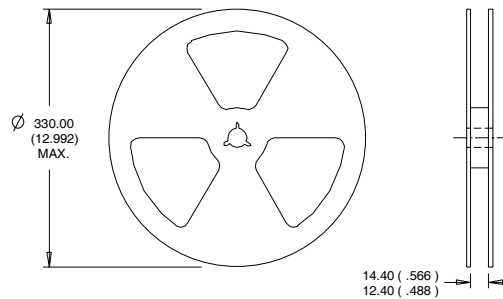

NOTES :

1. CONTROLLING DIMENSION : MILLIMETER.
2. OUTLINE CONFORMS TO EIA-481 & EIA-541.

Data and specifications subject to change without notice.
This product has been designed and qualified for the Consumer market.
Qualifications Standards can be found on IR's Web site.

International
IR Rectifier

IR WORLD HEADQUARTERS: 233 Kansas St., El Segundo, California 90245, USA Tel: (310) 252-7105
TAC Fax: (310) 252-7903

Visit us at www.irf.com for sales contact information.06/04

www.irf.com

Mouser Electronics

Authorized Distributor

Click to View Pricing, Inventory, Delivery & Lifecycle Information:

[International Rectifier:](#)

[IRF7324PBF](#) [IRF7324TRPBF](#)