



Is Now Part of



**ON Semiconductor®**

To learn more about ON Semiconductor, please visit our website at  
[www.onsemi.com](http://www.onsemi.com)

ON Semiconductor and the ON Semiconductor logo are trademarks of Semiconductor Components Industries, LLC dba ON Semiconductor or its subsidiaries in the United States and/or other countries. ON Semiconductor owns the rights to a number of patents, trademarks, copyrights, trade secrets, and other intellectual property. A listing of ON Semiconductor's product/patent coverage may be accessed at [www.onsemi.com/site/pdf/Patent-Marking.pdf](http://www.onsemi.com/site/pdf/Patent-Marking.pdf). ON Semiconductor reserves the right to make changes without further notice to any products herein. ON Semiconductor makes no warranty, representation or guarantee regarding the suitability of its products for any particular purpose, nor does ON Semiconductor assume any liability arising out of the application or use of any product or circuit, and specifically disclaims any and all liability, including without limitation special, consequential or incidental damages. Buyer is responsible for its products and applications using ON Semiconductor products, including compliance with all laws, regulations and safety requirements or standards, regardless of any support or applications information provided by ON Semiconductor. "Typical" parameters which may be provided in ON Semiconductor data sheets and/or specifications can and do vary in different applications and actual performance may vary over time. All operating parameters, including "Typicals" must be validated for each customer application by customer's technical experts. ON Semiconductor does not convey any license under its patent rights nor the rights of others. ON Semiconductor products are not designed, intended, or authorized for use as a critical component in life support systems or any FDA Class 3 medical devices or medical devices with a same or similar classification in a foreign jurisdiction or any devices intended for implantation in the human body. Should Buyer purchase or use ON Semiconductor products for any such unintended or unauthorized application, Buyer shall indemnify and hold ON Semiconductor and its officers, employees, subsidiaries, affiliates, and distributors harmless against all claims, costs, damages, and expenses, and reasonable attorney fees arising out of, directly or indirectly, any claim of personal injury or death associated with such unintended or unauthorized use, even if such claim alleges that ON Semiconductor was negligent regarding the design or manufacture of the part. ON Semiconductor is an Equal Opportunity/Affirmative Action Employer. This literature is subject to all applicable copyright laws and is not for resale in any manner.

# FPF2123-FPF2125 IntelliMAX™ Advanced Load Management Products

## Features

- 1.8 to 5.5V Input Voltage Range
- Controlled Turn-On
- 0.15-1.5A Adjustable Current Limit
- Undervoltage Lockout
- Thermal Shutdown
- <math>2\mu\text{A}</math> Shutdown Current
- Auto Restart
- Fast Current limit Response Time
  - 3 $\mu\text{s}$  to Moderate Over Currents
- Fault Blanking
- Reverse Current Blocking
- RoHS Compliant

## Applications

- PDAs
- Cell Phones
- GPS Devices
- MP3 Players
- Digital Cameras
- Peripheral Ports
- Hot Swap Supplies



## General Description

The FPF2123, FPF2124, and FPF2125 are a series of load switches which provide full protection to systems and loads which may encounter large current conditions. These devices contain a 0.125 $\Omega$  current-limited P-channel MOSFET which can operate over an input voltage range of 1.8-5.5V. The current limit is settable using an external resistor. Internally, current is prevented from flowing when the MOSFET is off and the output voltage is higher than the input voltage. Switch control is by a logic input (ON) capable of interfacing directly with low voltage control signals. Each part contains thermal shutdown protection which shuts off the switch to prevent damage to the part when a continuous over-current condition causes excessive heating.

When the switch current reaches the current limit, the parts operate in a constant-current mode to prohibit excessive currents from causing damage. For the FPF2123 and FPF2124 if the constant current condition still persists after 10ms, these parts will shut off the switch. The FPF2123 has an auto-restart feature which will turn the switch on again after 160ms if the ON pin is still active. The FPF2124 does not have this auto-restart feature so the switch will remain off after a current limit fault until the ON pin is cycled. The FPF2125 will not turn off after a current limit fault, but will rather remain in the constant current mode indefinitely. The minimum current limit is 150mA.

These parts are available in a space-saving 5 pin SOT23 package

## Typical Application Circuit

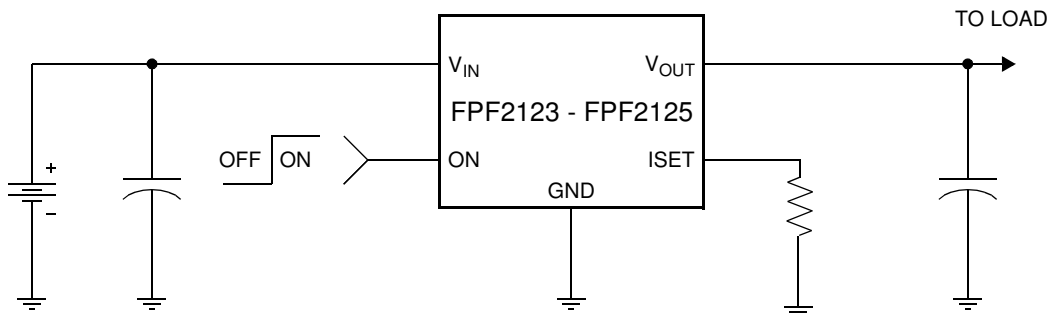

## Ordering Information

Part	Current Limit [A]	Current Limit Blanking Time [ms]	Auto-Restart Time [ms]	ON Pin Activity	Top Mark
FPF2123	0.15 - 1.5	5/10/20	80/160/320	Active HI	2123
FPF2124	0.15 - 1.5	5/10/20	NA	Active HI	2124
FPF2125	0.15 - 1.5	Infinite	NA	Active HI	2125

### Functional Block Diagram

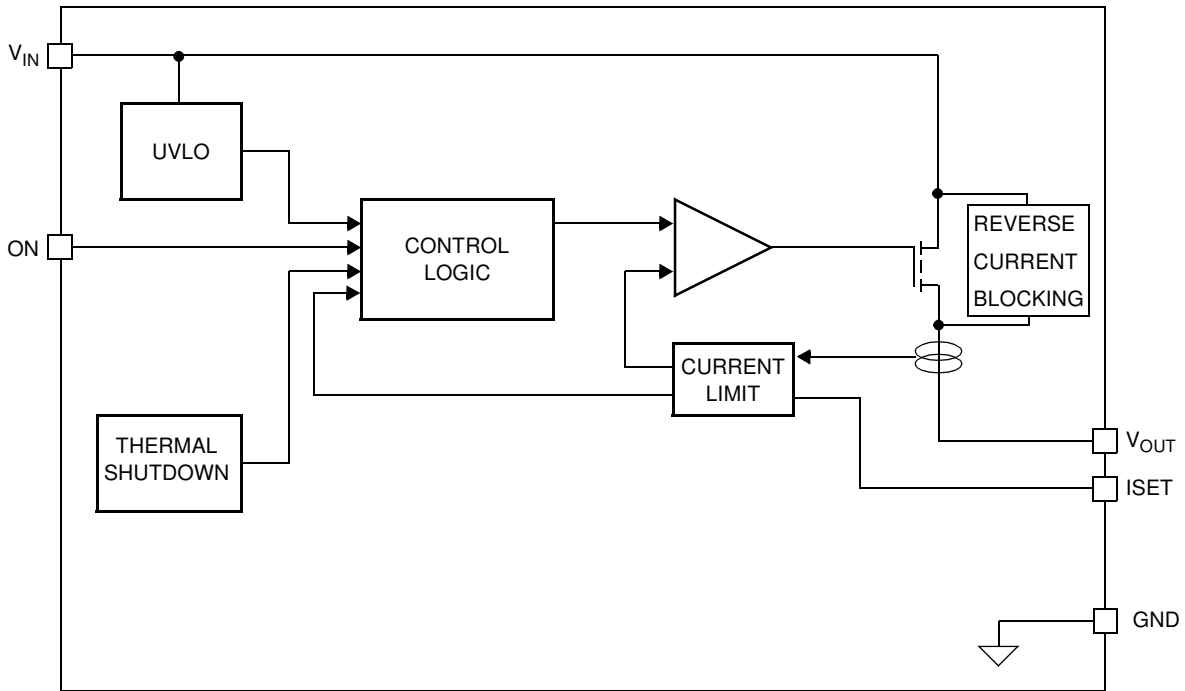

### Pin Configuration

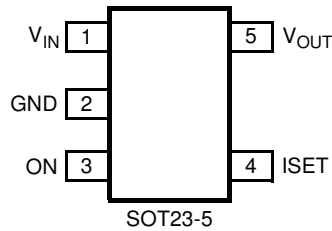

### Pin Description

Pin	Name	Function
1	V <sub>IN</sub>	Supply Input: Input to the power switch and the supply voltage for the IC
2	GND	Ground
3	ON	ON Control Input
4	ISET	Current Limit Set Input: A resistor from ISET to ground sets the current limit for the switch.
5	V <sub>OUT</sub>	Switch Output: Output of the power switch

## Absolute Maximum Ratings

Parameter	Min.	Max.	Unit
$V_{IN}$ , $V_{OUT}$ , ON, ISET to GND	-0.3	6	V
Power Dissipation @ $T_A = 25^\circ\text{C}$ (note 1)		667	mW
Operating Temperature Range	-40	125	$^\circ\text{C}$
Storage Temperature	-65	150	$^\circ\text{C}$
Thermal Resistance, Junction to Ambient		150	$^\circ\text{C}/\text{W}$
Electrostatic Discharge Protection	HBM	4000	V
	MM	400	V

## Recommended Operating Range

Parameter	Min.	Max.	Unit
$V_{IN}$	1.8	5.5	V
Ambient Operating Temperature, $T_A$	-40	85	$^\circ\text{C}$

## Electrical Characteristics

$V_{IN} = 1.8$  to  $5.5\text{V}$ ,  $T_A = -40$  to  $+85^\circ\text{C}$  unless otherwise noted. Typical values are at  $V_{IN} = 3.3\text{V}$  and  $T_A = 25^\circ\text{C}$ .

Parameter	Symbol	Conditions	Min.	Typ.	Max	Units
<b>Basic Operation</b>						
Operating Voltage	$V_{IN}$		1.8		5.5	V
Quiescent Current	$I_Q$	$I_{OUT} = 0\text{mA}$	$V_{IN} = 1.8$ to $3.3\text{V}$	75		$\mu\text{A}$
			$V_{IN} = 3.3$ to $5.5\text{V}$	80	120	
Shutdown Current	$I_{SHDN}$				2	$\mu\text{A}$
Reverse Block Leakage Current	$I_{BLOCK}$				1	$\mu\text{A}$
Latch-Off Current	$I_{LATCHOFF}$	FPF2124		50		$\mu\text{A}$
On-Resistance	$R_{ON}$	$V_{IN} = 3.3\text{V}$ , $I_{OUT} = 50\text{mA}$ , $T_A = 25^\circ\text{C}$		125	160	m $\Omega$
		$V_{IN} = 3.3\text{V}$ , $I_{OUT} = 50\text{mA}$ , $T_A = 85^\circ\text{C}$		150	200	
		$V_{IN} = 3.3\text{V}$ , $I_{OUT} = 50\text{mA}$ , $T_A = -40^\circ\text{C}$ to $+85^\circ\text{C}$	65		200	
ON Input Logic High Voltage (ON)	$V_{IH}$	$V_{IN} = 1.8\text{V}$	0.75			V
		$V_{IN} = 5.5\text{V}$	1.30			
ON Input Logic Low Voltage	$V_{IL}$	$V_{IN} = 1.8\text{V}$			0.5	V
		$V_{IN} = 5.5\text{V}$			1.0	
ON Input Leakage		$V_{ON} = V_{IN}$ or GND			1	$\mu\text{A}$
Off Switch Leakage	$I_{SWOFF}$	$V_{ON} = 0\text{V}$ , $V_{OUT} = 0\text{V}$			1	$\mu\text{A}$
<b>Protections</b>						
Current Limit	$I_{LIM}$	$V_{IN} = 3.3\text{V}$ , $V_{OUT} = 3.0\text{V}$ , RSET=576 $\Omega$	600	800	1000	mA
Min. Current Limit	$I_{LIM(min.)}$	$V_{IN} = 3.3\text{V}$ , $V_{OUT} = 3.0\text{V}$		150		mA
Thermal Shutdown		Shutdown Threshold		140		$^\circ\text{C}$
		Return from Shutdown		130		
		Hysteresis		10		
Under Voltage Shutdown	UVLO	$V_{IN}$ Increasing	1.5	1.6	1.7	V
Under Voltage Shutdown Hysteresis				50		mV

## Electrical Characteristics Cont.

$V_{IN} = 1.8$  to  $5.5V$ ,  $T_A = -40$  to  $+85^\circ C$  unless otherwise noted. Typical values are at  $V_{IN} = 3.3V$  and  $T_A = 25^\circ C$ .

Parameter	Symbol	Conditions	Min.	Typ.	Max	Units
<b>Dynamic</b>						
Turn on time	$t_{ON}$	$R_L = 500\Omega$ , $C_L = 0.1\mu F$		25		$\mu s$
Turn off time	$t_{OFF}$	$R_L = 500\Omega$ , $C_L = 0.1\mu F$		70		$\mu s$
$V_{OUT}$ Rise Time	$t_R$	$R_L = 500\Omega$ , $C_L = 0.1\mu F$		12		$\mu s$
$V_{OUT}$ Fall Time	$t_F$	$R_L = 500\Omega$ , $C_L = 0.1\mu F$		200		$\mu s$
Over Current Blanking Time	$t_{BLANK}$	FPF2123, FPF2124	5	10	20	ms
Auto-Restart Time	$t_{RESTART}$	FPF2123	80	160	320	ms
		FPF2124, FPF2125		NA		
Short Circuit Response Time		$V_{IN} = V_{ON} = 3.3V$ . Moderate Over-Current Condition.		3		$\mu s$
		$V_{IN} = V_{ON} = 3.3V$ . Hard Short.		20		$\mu s$

**Note 1:** Package power dissipation on 1square inch pad, 2 oz. copper board.

## Typical Characteristics

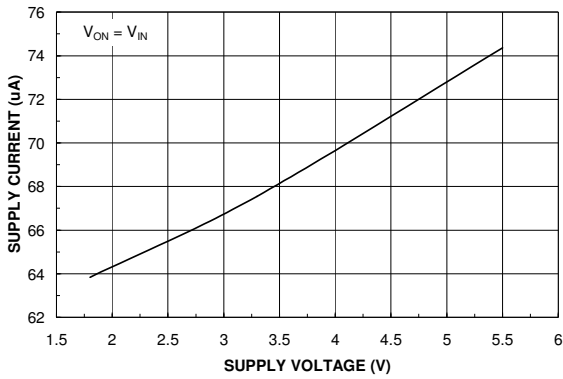

Figure 1. Quiescent Current vs. Input Voltage

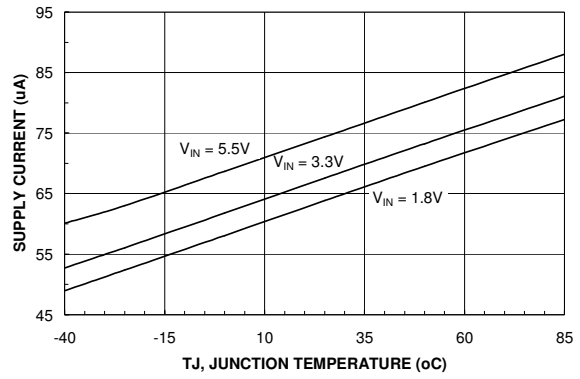

Figure 2. Quiescent Current vs. Temperature

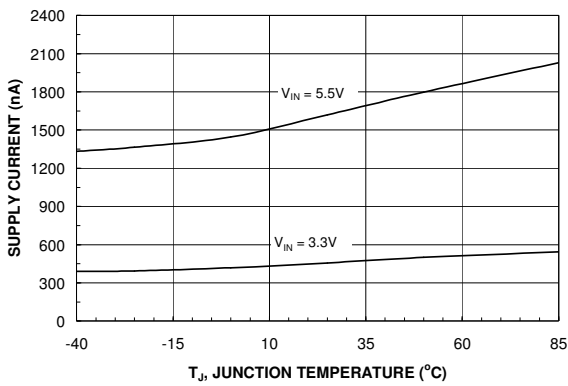

Figure 3. I<sub>SHUTDOWN</sub> Current vs. Temperature

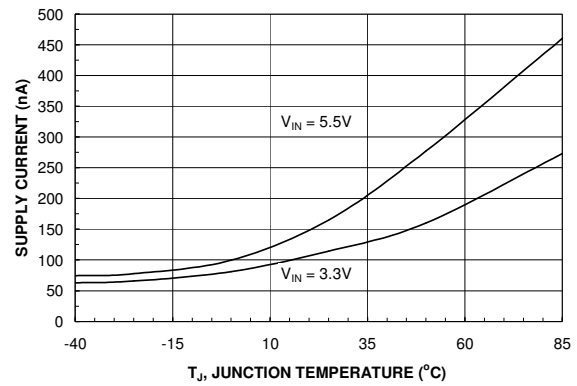

Figure 4. I<sub>SWITCH-OFF</sub> Current vs. Temperature

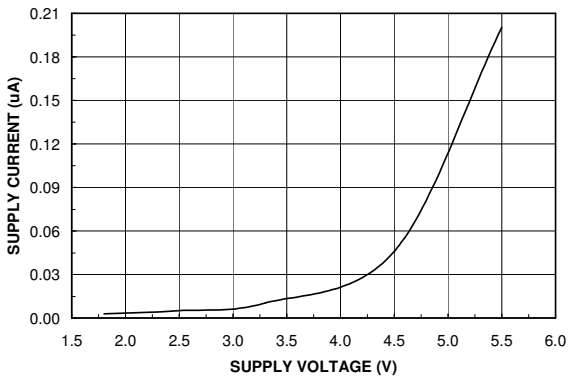

Figure 5. Reverse Current vs. V<sub>OUT</sub>

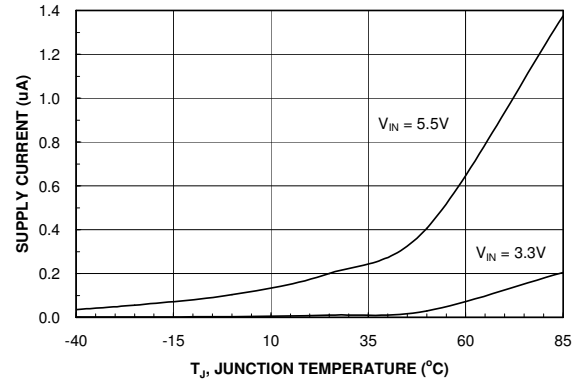

Figure 6. Reverse Current vs. Temperature

## Typical Characteristics

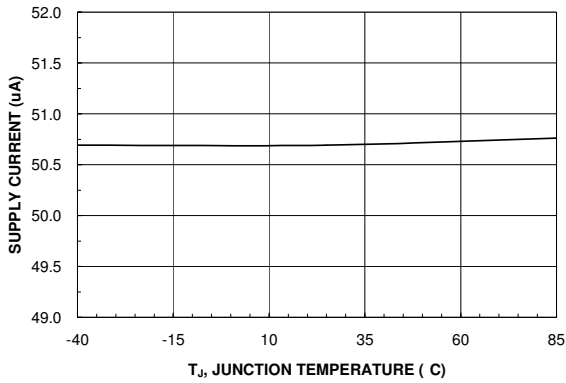

Figure 7.  $I_{LATCH-OFF}$  Current vs. Temperature

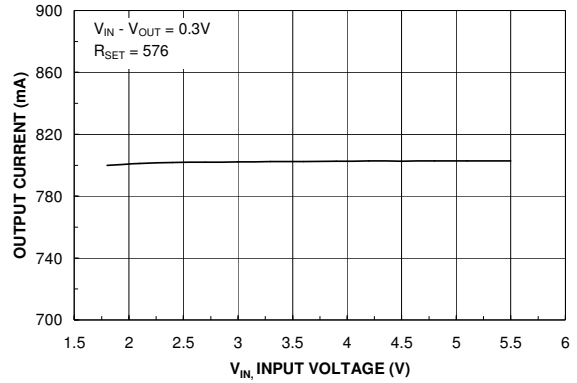

Figure 8. Current Limit vs. Input Voltage

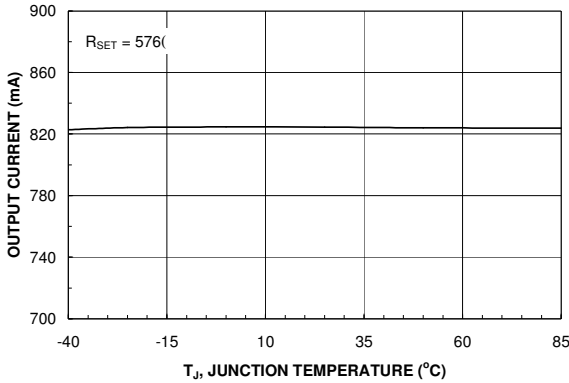

Figure 9. Current Limit vs. Temperature

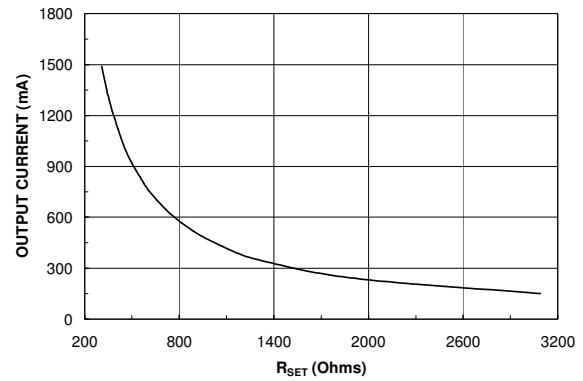

Figure 10. Current Limit vs. Rset

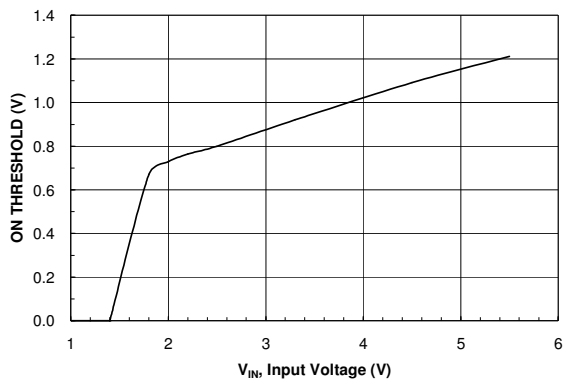

Figure 11.  $V_{IH}$  vs.  $V_{IN}$

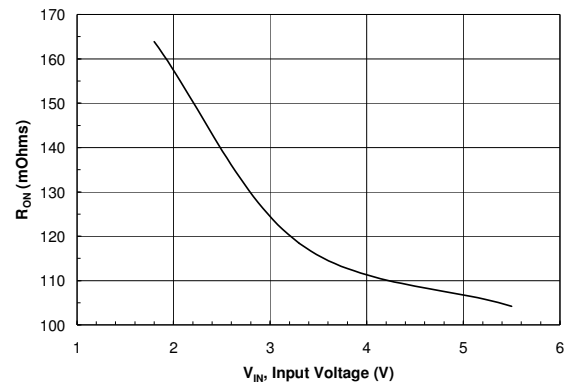

Figure 12.  $R_{ON}$  vs.  $V_{IN}$

## Typical Characteristics

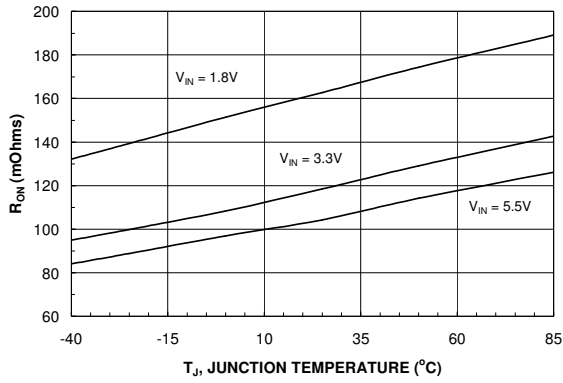

Figure 13. R<sub>(ON)</sub> vs. Temperature

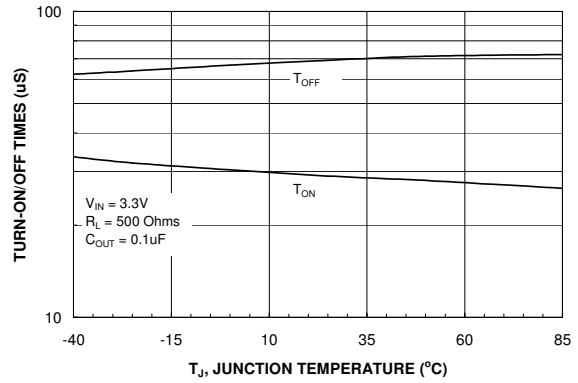

Figure 14. T<sub>ON</sub>/T<sub>OFF</sub> vs. Temperature

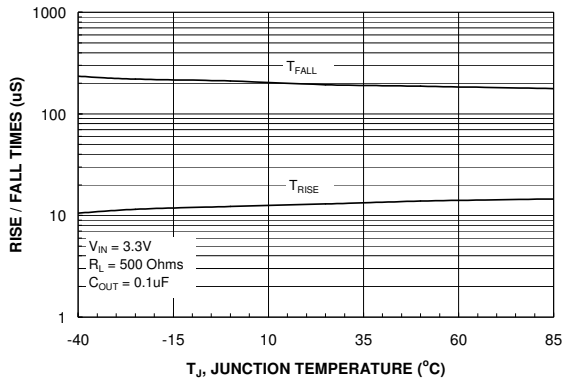

Figure 15. T<sub>RISE</sub>/T<sub>FALL</sub> vs. Temperature

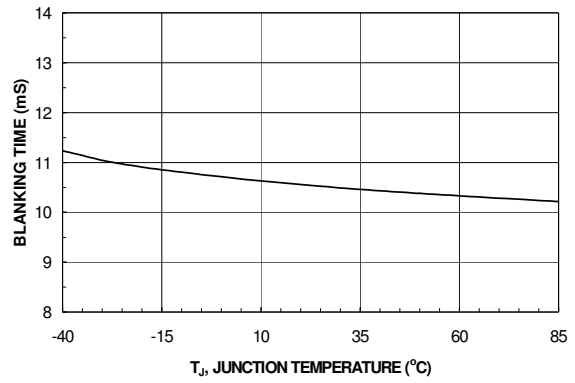

Figure 16. T<sub>BLANK</sub> vs. Temperature

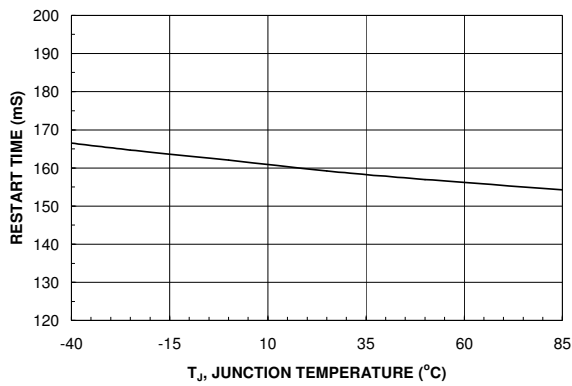

Figure 17. T<sub>RESTART</sub> vs. Temperature

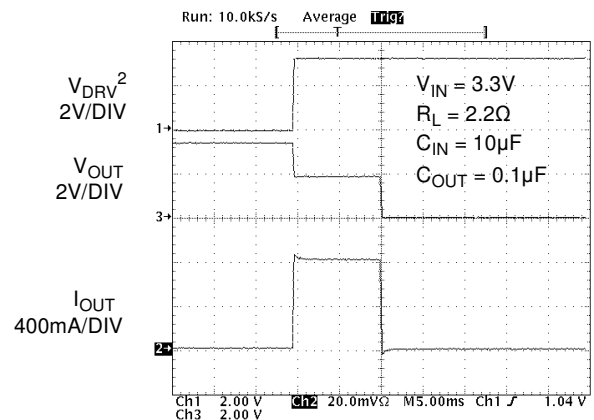

Figure 18. T<sub>BLANK</sub> Response



## Typical Characteristics

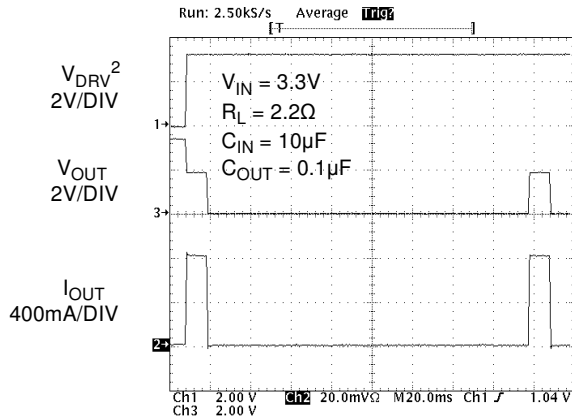

Figure 19.  $T_{RESTART}$  Response

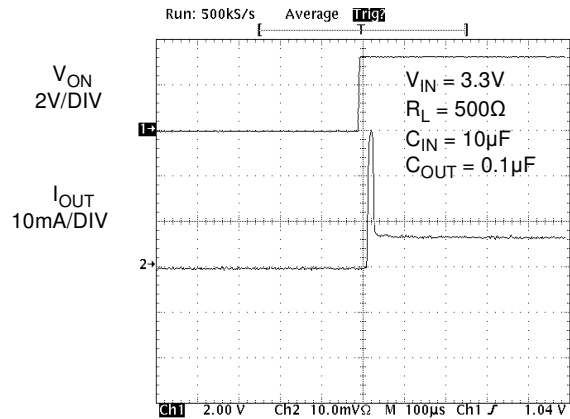

Figure 20.  $T_{ON}$  Response

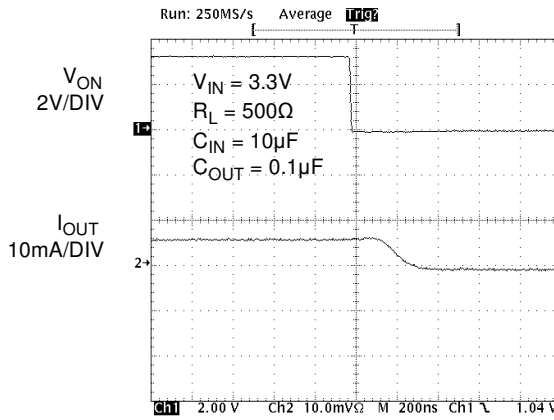

Figure 21.  $T_{OFF}$  Response

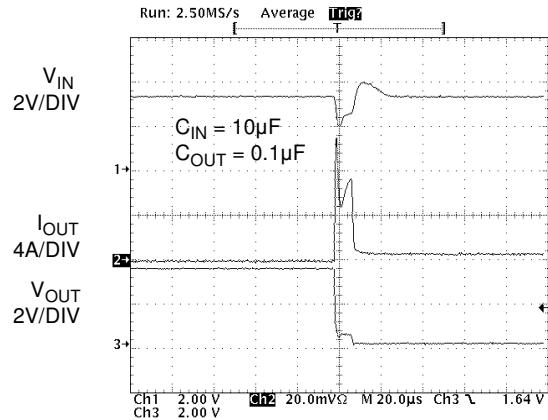

Figure 22. Short Circuit Response  
(Output Shorted to GND)

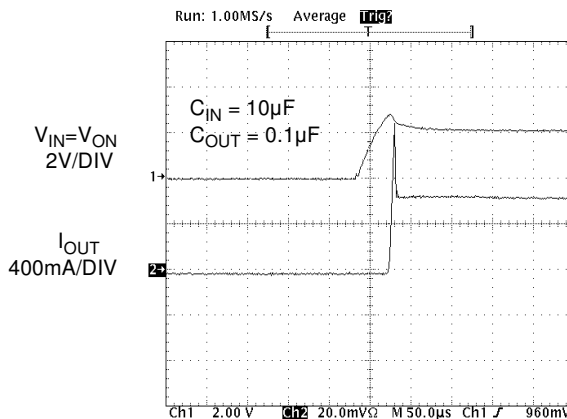

Figure 23. Current Limit Response  
(Switch power up to hard short)

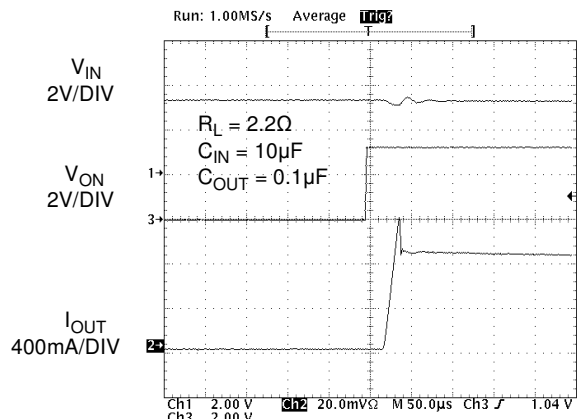

Figure 24. Current Limit Response  
(Output Shorted to GND by 2.2Ω, moderate short)

**Note 2:**  $V_{DRV}$  signal forces the device to go into overcurrent condition by loading a 2.2Ω resistor.

## Description of Operation

The FPF2123, FPF2124, and FPF2125 are current limited switches that protect systems and loads which can be damaged or disrupted by the application of high currents. The core of each device is a 0.125Ω P-channel MOSFET and a controller capable of functioning over a wide input operating range of 1.8-5.5V. The controller protects against system malfunctions through current limiting under-voltage lockout and thermal shutdown. The current limit is adjustable from 150mA to 1.5A through the selection of an external resistor.

### On/Off Control

The ON pin controls the state of the switch. When ON is high, the switch is in the on state. Activating ON continuously holds the switch in the on state so long as there is no fault. For all versions, an under-voltage on  $V_{IN}$  or a junction temperature in excess of 140°C overrides the ON control to turn off the switch. In addition, excessive currents will cause the switch to turn off in the FPF2123 and FPF2124. The FPF2123 has an Auto-Restart feature which will automatically turn the switch on again after 160ms. For the FPF2124, the ON pin must be toggled to turn-on the switch again. The FPF2125 does not turn off in response to an over current condition but instead remains operating in a constant current mode so long as ON is active and the thermal shutdown or under-voltage lockout have not activated.

The ON pin control voltage and  $V_{IN}$  pin have independent recommended operating ranges. The ON pin voltage can be driven by a voltage level higher than the input voltage.

### Current Limiting

The current limit ensures that the current through the switch doesn't exceed a maximum value while not limiting at less than a minimum value. The current at which the parts will limit is adjustable through the selection of an external resistor connected to ISET. Information for selecting the resistor is found in the Application Info section. The FPF2123 and FPF2124 have a blanking time of 10ms, nominally, during which the switch will act as a constant current source. At the end of the blanking time, the switch will be turned-off. The FPF2125 has no current limit blanking period so it will remain in a constant current state until the ON pin is deactivated or the thermal shutdown turns-off the switch.

### Under-Voltage Lockout

The under-voltage lockout turns-off the switch if the input voltage drops below the under-voltage lockout threshold. With the ON pin active, the input voltage rising above the under-voltage lockout threshold will cause a controlled turn-on of the switch which limits current over-shoots.

### Thermal Shutdown

The thermal shutdown protects the die from internally or externally generated excessive temperatures. During an over-temperature condition the switch is turned-off. The switch automatically turns-on again if the temperature of the die drops below the threshold temperature.

## Application Information

### Typical Application

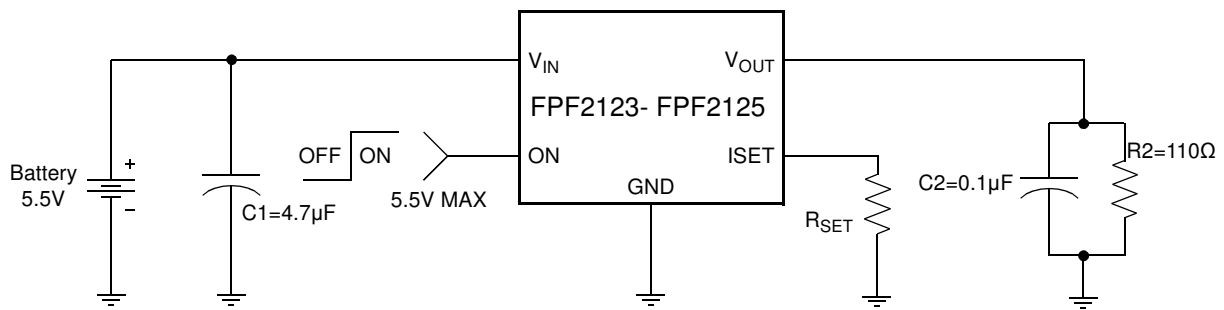

### Setting Current Limit

The FPF2123, FPF2124, and FPF2125 have a current limit which is set with an external resistor connected between ISET and GND. This resistor is selected by using the following equation,

$$R_{SET} = \frac{460}{I_{LIM}}$$

$R_{SET}$  is in Ohms and that of  $I_{LIM}$  is Amps

The table below can also be used to select  $R_{SET}$ . A typical application would be the 500mA current that is required by a single USB port. Using the table below an appropriate selection for the  $R_{SET}$  resistor would be 604Ω. This will ensure that the port load could draw 570mA, but not more than 950mA. Likewise for a dual port system, an  $R_{SET}$  of 340Ω would always deliver at least 1120mA and never more than 1860mA.

### Input Capacitor

To limit the voltage drop on the input supply caused by transient in-rush currents when the switch turns-on into a discharged load capacitance or a short-circuit, a capacitor needs to be placed between  $V_{IN}$  and GND. A 4.7µF ceramic capacitor,  $C_{IN}$ , must be placed close to the  $V_{IN}$  pin. A higher value of  $C_{IN}$  can be used to further reduce the voltage drop experienced as the switch is turned on into a large capacitive load.

### Output Capacitor

A 0.1µF capacitor,  $C_{OUT}$ , should be placed between  $V_{OUT}$  and GND. This capacitor will prevent parasitic board inductances from forcing  $V_{OUT}$  below GND when the switch turns-off. For the FPF2123 and FPF2124, the total output capacitance needs to be kept below a maximum value,  $C_{OUT(max)}$ , to prevent the part from registering an over-current condition and turning-off the switch. The maximum output capacitance can be determined from the following formula,

$$C_{OUT(max)} = \frac{I_{LIM(min)} \times t_{BLANK(min)}}{V_{IN}}$$

### Current Limit Various $R_{SET}$ Values

$R_{SET}$ [Ω]	Min. Current Limit [mA]	Typ. Current Limit [mA]	Max. Current Limit [mA]
309	1120	1490	1860
340	1010	1350	1690
374	920	1230	1540
412	840	1120	1400
453	760	1010	1270
499	690	920	1150
549	630	840	1050
576	600	800	1000
604	570	760	950
732	470	630	790
887	390	520	650
1070	320	430	540
1300	260	350	440
1910	180	240	300
3090	110	150	190

### Power Dissipation

During normal operation as a switch, the power dissipated in the part will depend upon the level at which the current limit is set. The maximum allowed setting for the current limit is 1.5A and this will result in a typical power dissipation of,

$$P = (I_{LIM})^2 \times R_{ON} = (1.5)^2 \times 0.125 = 281\text{mW}$$

If the part goes into current limit the maximum power dissipation will occur when the output is shorted to ground. For the FPF2123 the power dissipation will scale by the Auto-Restart Time,  $t_{RESTART}$ , and the Over Current Blanking Time,  $t_{BLANK}$ , so that the maximum power dissipated is,

$$P(max) = \frac{t_{BLANK(max)}}{t_{RESTART(min)} + t_{BLANK(max)}} \times V_{IN(max)} \times I_{LIM(max)} \quad (4)$$

$$= \frac{20}{80 + 20} \times 5.5 \times 1.5 = 1.65\text{W}$$

This is more power than the package can dissipate, but the thermal shutdown of the part will activate to protect the part from damage due to excessive heating. When using the FPF2124, attention must be given to the manual resetting of the part. Continuously resetting the part when a short on the output is present will cause the temperature of the part to increase. The junction temperature will only be able to increase to the thermal shutdown threshold. Once this temperature has been reached, toggling ON will not turn-on the switch until the junction temperature drops. For the FPF2125, a short on the output will cause the part to operate in a constant current state dissipating a worst case power of,

$$\begin{aligned} P(\text{max}) &= V_{\text{IN}}(\text{max}) \times I_{\text{LM}}(\text{max}) & (5) \\ &= 5.5 \times 1.5 = 8.25\text{W} \end{aligned}$$

This large amount of power will activate the thermal shutdown and the part will cycle in and out of thermal shutdown so long as the ON pin is active and the short is present.

### Board Layout

For best performance, all traces should be as short as possible. To be most effective, the input and output capacitors should be placed close to the device to minimize the effects that parasitic trace inductances may have on normal and short-circuit operation. Using wide traces for  $V_{\text{IN}}$ ,  $V_{\text{OUT}}$  and GND will help minimize parasitic electrical effects along with minimizing the case to ambient thermal impedance.

Dimensional Outline and Pad Layout

Package MA05B

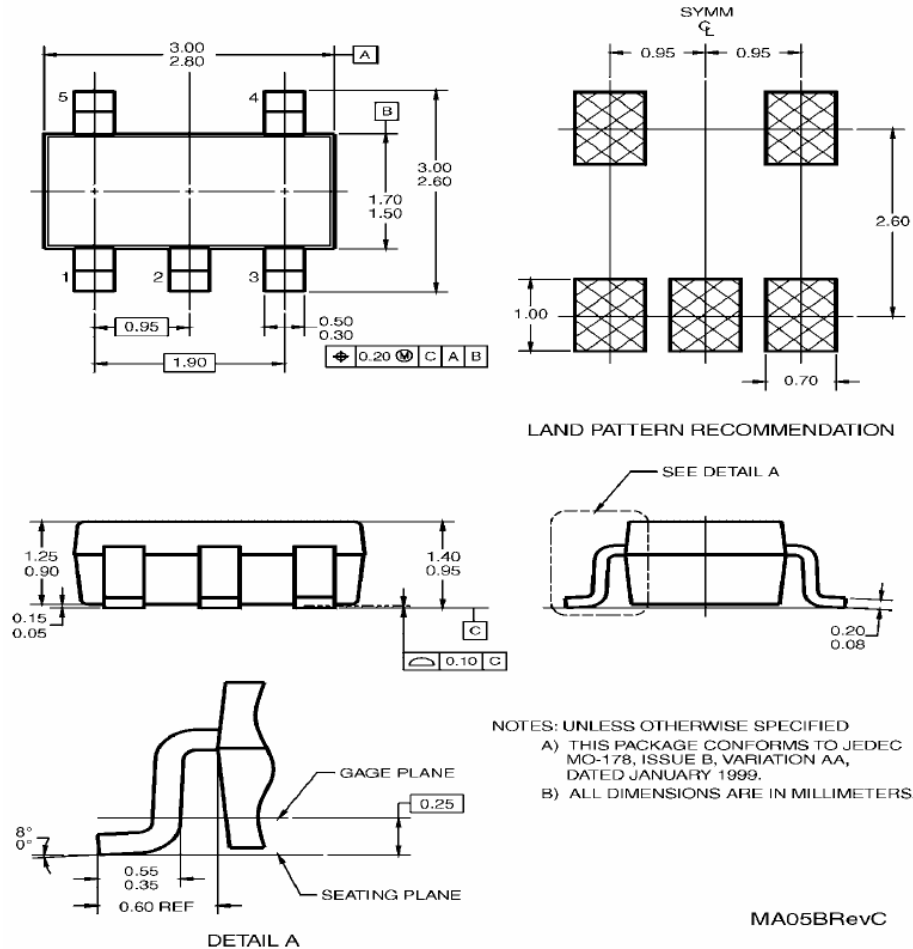







5-Lead SOT23, JEDEC MO-178, 1.6mm  
 Package Number MA05B



### TRADEMARKS

The following includes registered and unregistered trademarks and service marks, owned by Fairchild Semiconductor and/or its global subsidiaries, and is not intended to be an exhaustive list of all such trademarks.

- |   |   |   |   |
|---|---|---|---|
| Build it Now™   | FRFET®  | Programmable Active Droop™  | The Power Franchise®  |
| CorePLUS™   | Global Power ResourceSM   | QFET®   | the power franchise   |
| CorePOWER™  | Green FPS™  | QS™   | TinyBoost™  |
| CROSSVOLT™  | Green FPS™ e-Series™  | Quiet Series™   | TinyBuck™   |
| CTL™  | GTO™  | RapidConfigure™   | TinyLogic®  |
| Current Transfer Logic™   | IntelliMAX™   |  ™ | TINYOPTO™   |
| EcoSPARK®   | ISOPLANAR™  | Saving our world, 1mW at a time™  | TinyPower™  |
| EfficientMax™   | MegaBuck™   | Saving our world, 1W at a time™   | TinyPWM™  |
| EZSWITCH™ *   | MICROCOUPLER™   | Saving our world, 1kW at a time™  | TinyWire™   |
|  ™ | MicroFET™   | SmartMax™   | µSerDes™  |
|  ® | MicroPak™   | SMART START™  |  ™ |
| Fairchild®  | MillerDrive™  | SPM®  | SerDes®   |
| Fairchild Semiconductor®  | MotionMax™  | STEALTH™  | UHC®  |
| FACT Quiet Series™  | Motion-SPM™   | SuperFET™   | Ultra FRFET™  |
| FACT®   | OPTOLOGIC®  | SuperSOT™-3   | UniFET™   |
| FAST®   | OPTOPLANAR®   | SuperSOT™-6   | VCX™  |
| FastvCore™  |  ® | SuperSOT™-8   | VisualMax™  |
| FlashWriter® *  | PDP SPM™  | SupreMOS™   |   |
| FPS™  | Power-SPM™  | SyncFET™  |   |
| F-PFS™  | PowerTrench®  |  ™ |   |

\* EZSWITCH™ and FlashWriter® are trademarks of System General Corporation, used under license by Fairchild Semiconductor.

### DISCLAIMER

FAIRCHILD SEMICONDUCTOR RESERVES THE RIGHT TO MAKE CHANGES WITHOUT FURTHER NOTICE TO ANY PRODUCTS HEREIN TO IMPROVE RELIABILITY, FUNCTION, OR DESIGN. FAIRCHILD DOES NOT ASSUME ANY LIABILITY ARISING OUT OF THE APPLICATION OR USE OF ANY PRODUCT OR CIRCUIT DESCRIBED HEREIN; NEITHER DOES IT CONVEY ANY LICENSE UNDER ITS PATENT RIGHTS, NOR THE RIGHTS OF OTHERS. THESE SPECIFICATIONS DO NOT EXPAND THE TERMS OF FAIRCHILD'S WORLDWIDE TERMS AND CONDITIONS, SPECIFICALLY THE WARRANTY THEREIN, WHICH COVERS THESE PRODUCTS.

### LIFE SUPPORT POLICY

FAIRCHILD'S PRODUCTS ARE NOT AUTHORIZED FOR USE AS CRITICAL COMPONENTS IN LIFE SUPPORT DEVICES OR SYSTEMS WITHOUT THE EXPRESS WRITTEN APPROVAL OF FAIRCHILD SEMICONDUCTOR CORPORATION.

As used herein:

- Life support devices or systems are devices or systems which, (a) are intended for surgical implant into the body or (b) support or sustain life, and (c) whose failure to perform when properly used in accordance with instructions for use provided in the labeling, can be reasonably expected to result in a significant injury of the user.
- A critical component in any component of a life support, device, or system whose failure to perform can be reasonably expected to cause the failure of the life support device or system, or to affect its safety or effectiveness.

### ANTI-COUNTERFEITING POLICY

Fairchild Semiconductor Corporation's Anti-Counterfeiting Policy. Fairchild's Anti-Counterfeiting Policy is also stated on our external website, [www.fairchildsemi.com](http://www.fairchildsemi.com), under Sales Support.

Counterfeiting of semiconductor parts is a growing problem in the industry. All manufacturers of semiconductor products are experiencing counterfeiting of their parts. Customers who inadvertently purchase counterfeit parts experience many problems such as loss of brand reputation, substandard performance, failed application, and increased cost of production and manufacturing delays. Fairchild is taking strong measures to protect ourselves and our customers from the proliferation of counterfeit parts. Fairchild strongly encourages customers to purchase Fairchild parts either directly from Fairchild or from Authorized Fairchild Distributors who are listed by country on our web page cited above. Products customers buy either from fairchild directly or from Authorized Fairchild Distributors are genuine parts, have full traceability, meet Fairchild's quality standards for handling and storage and provide access to Fairchild's full range of up-to-date technical and product information. Fairchild and our Authorized Distributors will stand behind all warranties and will appropriately address and warranty issues that may arise. Fairchild will not provide any warranty coverage or other assistance for parts bought from Unauthorized Sources. Fairchild is committed to combat this global problem and encourage our customers to do their part in stopping this practice by buying direct or from authorized distributors.

### PRODUCT STATUS DEFINITIONS

#### Definition of Terms

Datasheet Identification	Product Status	Definition
Advance Information	Formative / In Design	Datasheet contains the design specifications for product development. Specifications may change in any manner without notice.
Preliminary	First Production	Datasheet contains preliminary data; supplementary data will be published at a later date. Fairchild Semiconductor reserves the right to make changes at any time without notice to improve design.
No Identification Needed	Full Production	Datasheet contains final specifications. Fairchild Semiconductor reserves the right to make changes at any time without notice to improve the design.
Obsolete	Not In Production	Datasheet contains specifications on a product that is discontinued by Fairchild Semiconductor. The datasheet is for reference information only.

Rev. 136

# Mouser Electronics

Authorized Distributor

Click to View Pricing, Inventory, Delivery & Lifecycle Information:

[Fairchild Semiconductor:](#)

[FPF2123](#)