



January 2016

# FJ15603D NPN Silicon Transistor

## Applications

- High Voltage and High Speed Power Switch Application
- Electronic Ballast Application

## Features

- Wide Safe Operating Area
- Small Variance in Storage Time
- Built-in Free Wheeling Diode

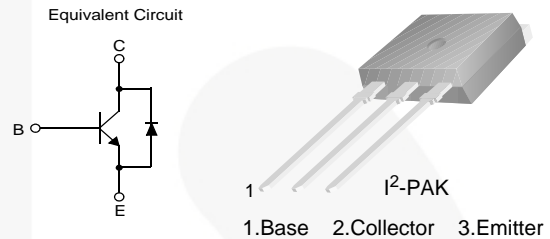

## Ordering Information

Part Number	Marking	Package	Packing Method
FJ15603DTU	J5603D	TO-262 3L (I2PAK)	Rail

## Absolute Maximum Ratings

Stresses exceeding the absolute maximum ratings may damage the device. The device may not function or be operable above the recommended operating conditions and stressing the parts to these levels is not recommended. In addition, extended exposure to stresses above the recommended operating conditions may affect device reliability. The absolute maximum ratings are stress ratings only. Values are at  $T_A = 25^\circ\text{C}$  unless otherwise noted.

Symbol	Parameter	Value	Unit
$V_{CBO}$	Collector-Base Voltage	1600	V
$V_{CEO}$	Collector-Emitter Voltage	800	V
$V_{EBO}$	Emitter-Base Voltage	12	V
$I_C$	Collector Current (DC)	3	A
$I_{CP}$	Collector Current (Pulse) <sup>(1)</sup>	6	A
$I_B$	Base Current (DC)	2	A
$I_{BP}$	Base Current (Pulse) <sup>(1)</sup>	4	A
$P_C$	Power Dissipation ( $T_C = 25^\circ\text{C}$ )	100	W
$T_J$	Junction Temperature	150	$^\circ\text{C}$
$T_{STG}$	Storage Junction Temperature Range	-65 to +150	$^\circ\text{C}$
EAS	Avalanche Energy ( $T_J = 25^\circ\text{C}$ , 8 mH)	3.5	mJ

### Notes:

1. Pulse test: pulse width = 5 ms, duty cycle  $\leq 10\%$

**Thermal Characteristics<sup>(2)</sup>**

Values are at  $T_A = 25^\circ\text{C}$  unless otherwise noted.

Symbol	Parameter	Rating	Unit
$R_{\theta JC}$	Thermal Resistance, Junction-to-Case	1.25	$^\circ\text{C/W}$
$R_{\theta JA}$	Thermal Resistance, Junction-to-Ambient	80	$^\circ\text{C/W}$

**Note:**

2. Device mounted on minimum pad size.

**Electrical Characteristics<sup>(3)</sup>**

Values are at  $T_A = 25^\circ\text{C}$  unless otherwise noted.

Symbol	Parameter	Conditions	Min.	Typ.	Max.	Unit	
$BV_{CBO}$	Collector-Base Breakdown Voltage	$I_C = 0.5\text{ mA}, I_E = 0$	1600	1689		V	
$BV_{CEO}$	Collector-Emitter Breakdown Voltage	$I_C = 5\text{ mA}, I_B = 0$	800	870		V	
$BV_{EBO}$	Emitter-Base Breakdown Voltage	$I_E = 0.5\text{ mA}, I_C = 0$	12.0	14.8		V	
$I_{CES}$	Collector Cut-Off Current	$V_{CE} = 1600\text{ V}, V_{BE} = 0$	$T_C = 25^\circ\text{C}$	0.01	100	$\mu\text{A}$	
			$T_C = 125^\circ\text{C}$		1000		
$I_{CEO}$	Collector Cut-Off Current	$V_{CE} = 800\text{ V}, I_B = 0$	$T_C = 25^\circ\text{C}$	0.01	100	$\mu\text{A}$	
			$T_C = 125^\circ\text{C}$		1000		
$I_{EBO}$	Emitter Cut-Off Current	$V_{EB} = 12\text{ V}, I_C = 0$		0.05	500	$\mu\text{A}$	
$h_{FE}$	DC Current Gain	$V_{CE} = 3\text{ V}, I_C = 0.4\text{ A}$	$T_C = 25^\circ\text{C}$	20	29	35	
			$T_C = 125^\circ\text{C}$	6	15		
		$V_{CE} = 10\text{ V}, I_C = 5\text{ mA}$	$T_C = 25^\circ\text{C}$	20	43		
			$T_C = 125^\circ\text{C}$	20	46		
$V_{CE(sat)}$	Collector-Emitter Saturation Voltage	$I_C = 250\text{ mA}, I_B = 25\text{ mA}$		0.50	1.25	V	
		$I_C = 500\text{ mA}, I_B = 50\text{ mA}$		1.50	2.50		
		$I_C = 1\text{ A}, I_B = 0.2\text{ A}$		1.20	2.50		
$V_{BE(sat)}$	Base-Emitter Saturation Voltage	$I_C = 500\text{ mA}, I_B = 50\text{ mA}$	$T_C = 25^\circ\text{C}$	0.74	1.20	V	
			$T_C = 125^\circ\text{C}$	0.61	1.10		
		$I_C = 2\text{ A}, I_B = 0.4\text{ A}$	$T_C = 25^\circ\text{C}$	0.85	1.20		
			$T_C = 125^\circ\text{C}$	0.74	1.10		
$C_{ib}$	Input Capacitance	$V_{EB} = 10\text{ V}, I_C = 0, f = 1\text{ MHz}$		745	1000	pF	
$C_{ob}$	Output Capacitance	$V_{CB} = 10\text{ V}, I_E = 0, f = 1\text{ MHz}$		56	500	pF	
$f_T$	Current Gain Bandwidth Product	$I_C = 0.1\text{ A}, V_{CE} = 10\text{ V}$		5		MHz	
$V_F$	Diode Forward Voltage	$I_F = 0.4\text{ A}$		0.76	1.20	V	
		$I_F = 1\text{ A}$		0.83	1.50		

**Note:**

3. Pulse test: pulse width = 20  $\mu\text{s}$ , duty cycle  $\leq 10\%$ .

**Electrical Characteristics** (Continued)

Values are at  $T_A = 25^\circ\text{C}$  unless otherwise noted.

Symbol	Parameter	Conditions	Min.	Typ.	Max.	Unit
RESISTIVE LOAD SWITCHING (D.C $\leq$ 10%, Pulse Width = 20 $\mu\text{s}$ )						
$t_{\text{ON}}$	Turn-On Time	$I_C = 0.3\text{ A}$ , $I_{B1} = 50\text{ mA}$ , $I_{B2} = 150\text{ mA}$ , $V_{CC} = 125\text{ V}$ , $R_L = 416\ \Omega$		400	600	ns
$t_{\text{STG}}$	Storage Time		1.9	2.1	2.3	$\mu\text{s}$
$t_F$	Fall Time			310	1000	ns
$t_{\text{ON}}$	Turn-On Time	$I_C = 0.5\text{ A}$ , $I_{B1} = 50\text{ mA}$ , $I_{B2} = 250\text{ mA}$ , $V_{CC} = 125\text{ V}$ , $R_L = 250\ \Omega$		600	1100	ns
$t_{\text{STG}}$	Storage Time			1.3	1.5	$\mu\text{s}$
$t_F$	Fall Time			180	350	ns
INDUCTIVE LOAD SWITCHING ( $V_{CC} = 15\text{ V}$ )						
$t_{\text{STG}}$	Storage Time	$I_C = 0.3\text{ A}$ , $I_{B1} = 50\text{ mA}$ , $I_{B2} = 150\text{ mA}$ , $V_Z = 300\text{ V}$ , $L_C = 200\text{ H}$	0.8		1.2	$\mu\text{s}$
$t_F$	Fall Time			170	250	ns
$t_C$	Cross-Over Time			180	250	ns
$t_{\text{STG}}$	Storage Time	$I_C = 0.5\text{ A}$ , $I_{B1} = 50\text{ mA}$ , $I_{B2} = 250\text{ mA}$ , $V_Z = 300\text{ V}$ , $L_C = 200\text{ H}$	0.8		1.2	$\mu\text{s}$
$t_F$	Fall Time			140	175	ns
$t_C$	Cross-Over Time			170	200	ns

## Typical Performance Characteristics

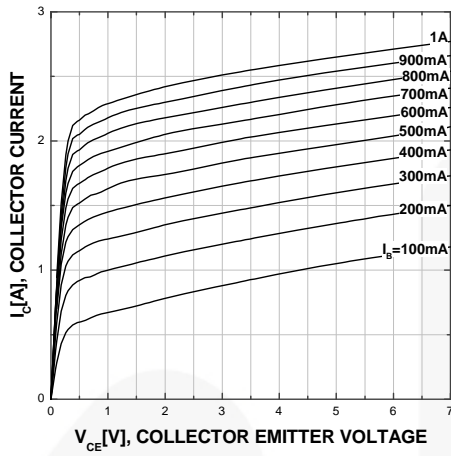

Figure 1. Static Characteristic

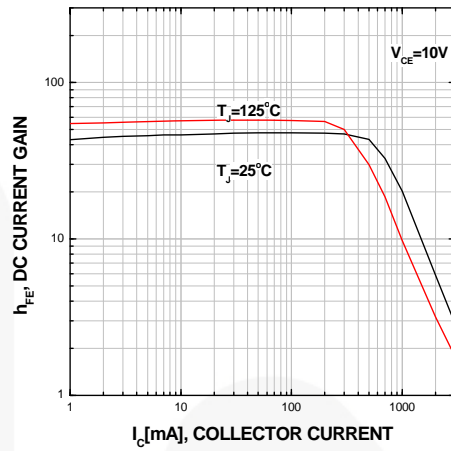

Figure 2. DC Current Gain

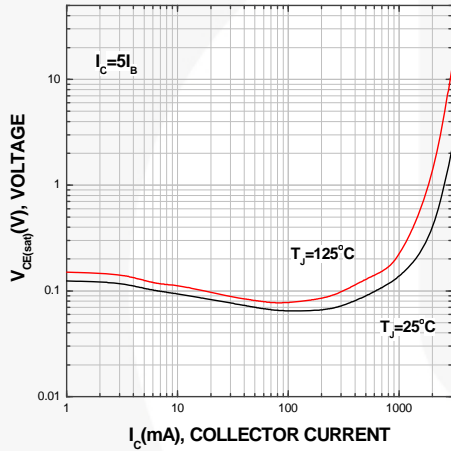

Figure 3. Collector-Emitter Saturation Voltage

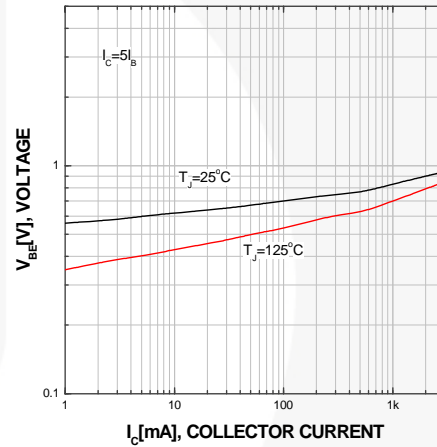

Figure 4. Base-Emitter Saturation Voltage

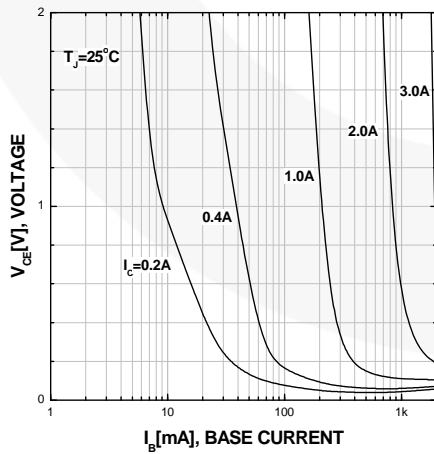

Figure 5. Typical Collector Saturation Voltage

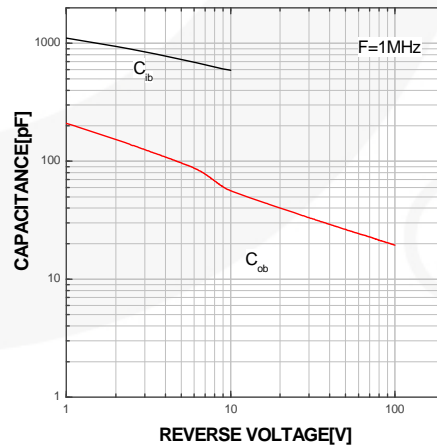

Figure 6. Capacitance

Typical Performance Characteristics (Continued)

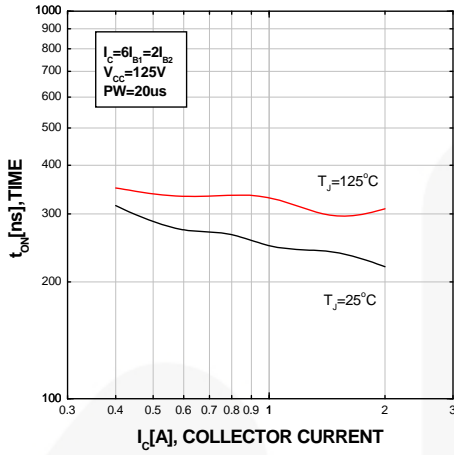

Figure 7. Resistive Switching Time,  $t_{on}$

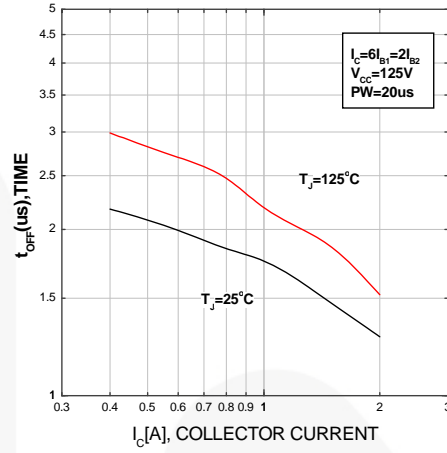

Figure 8. Resistive Switching Time,  $t_{off}$

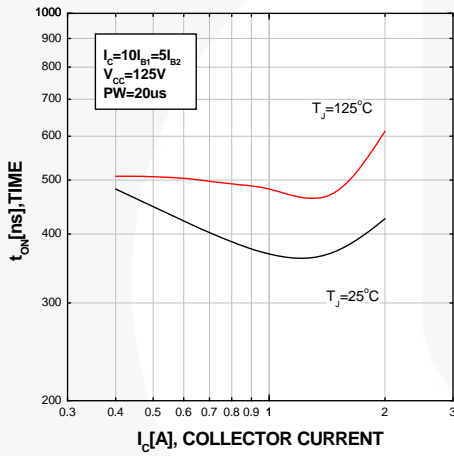

Figure 9. Resistive Switching Time,  $t_{on}$

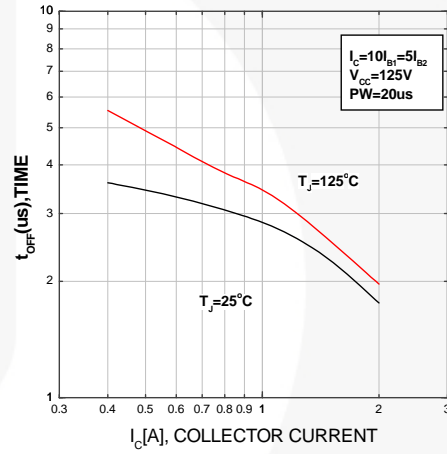

Figure 10. Resistive Switching Time,  $t_{off}$

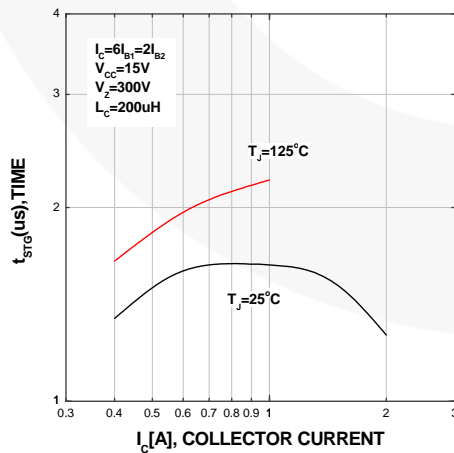

Figure 11. Inductive Switching Time,  $t_{STG}$

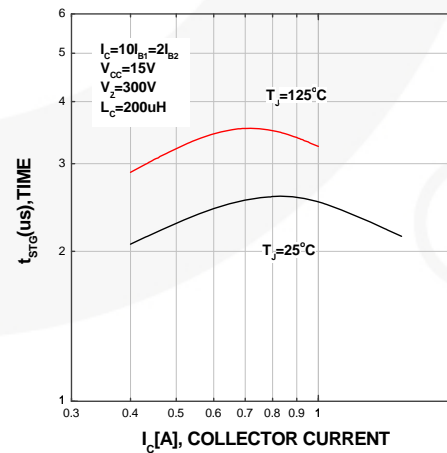

Figure 12. Inductive Switching Time,  $t_{STG}$

Typical Performance Characteristics (Continued)

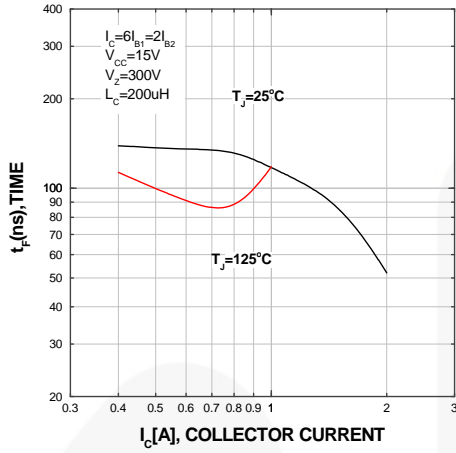

Figure 13. Inductive Switching Time,  $t_f$

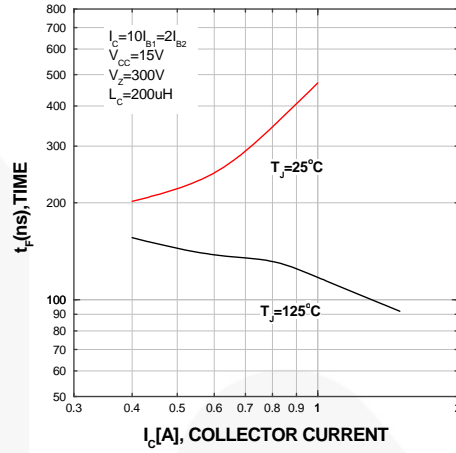

Figure 14. Inductive Switching Time,  $t_f$

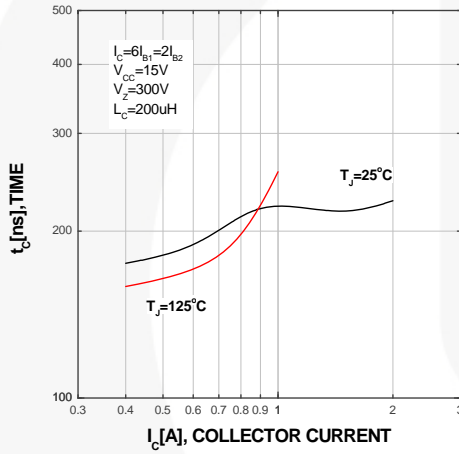

Figure 15. Inductive Switching Time,  $t_c$

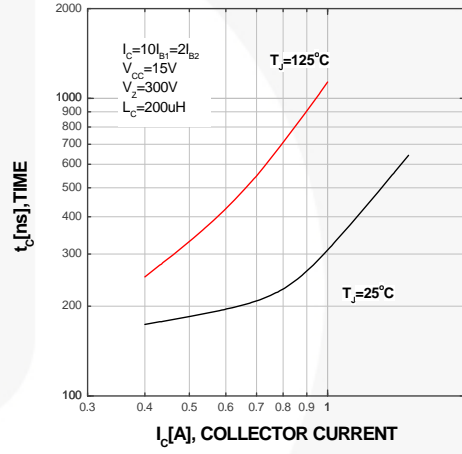

Figure 16. Inductive Switching Time,  $t_c$

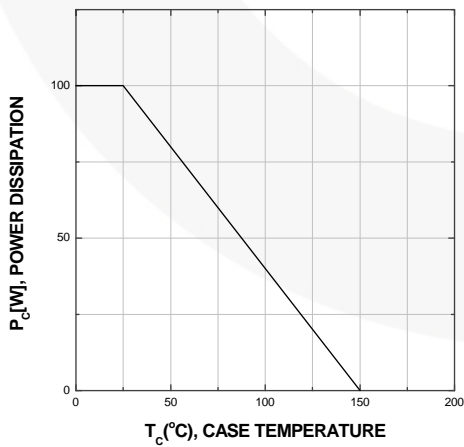
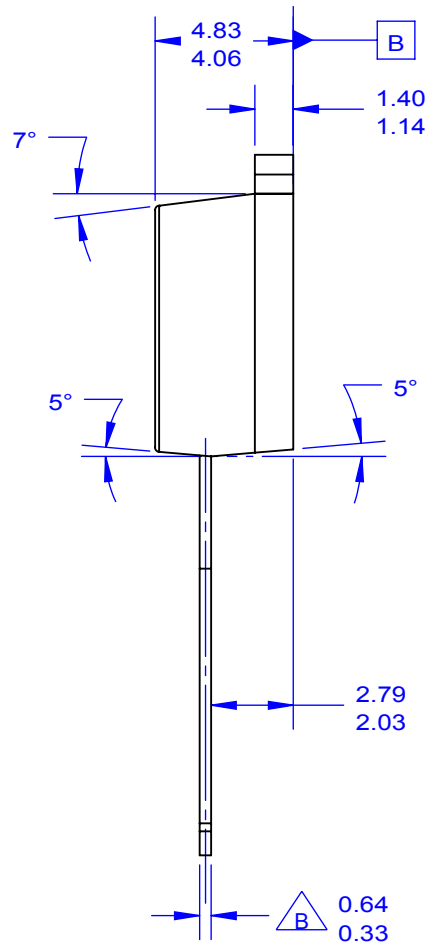
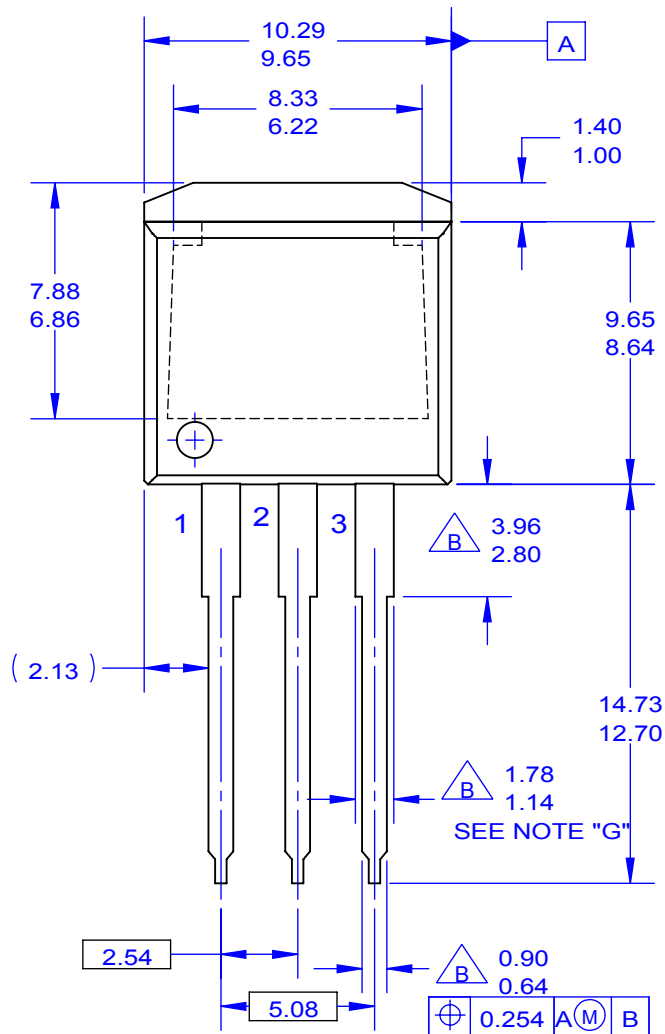

Figure 17. Power Derating



NOTES:

- A. EXCEPT WHERE NOTED CONFORMS TO TO262 JEDEC VARIATION AA.
- B. DOES NOT COMPLY JEDEC STD. VALUE.
- C. ALL DIMENSIONS ARE IN MILLIMETERS.
- D. DIMENSIONS ARE EXCLUSIVE OF BURRS, MOLD FLASH AND TIE BAR PROTRUSIONS.
- E. DIMENSION AND TOLERANCE AS PER ANSI Y14.5-1994.
- F. LOCATION OF PIN HOLE MAY VARY (LOWER LEFT CORNER, LOWER CENTER AND CENTER OF PACKAGE)
- G. MAXIMUM WIDTH FOR F102 DEVICE = 1.35 MAX.
- H. DRAWING FILE NAME: TO262A03REV6





**TRADEMARKS**

The following includes registered and unregistered trademarks and service marks, owned by Fairchild Semiconductor and/or its global subsidiaries, and is not intended to be an exhaustive list of all such trademarks.

- |                          |  |                                       |                  |
|--------------------------|--|---------------------------------------|------------------|
| AccuPower™               | F-PFS™   | OPTOPLANAR®                           | SYSTEM GENERAL®  |
| AttitudeEngine™          | FRFET®   | Power Supply WebDesigner™             | TinyBoost®       |
| Awinda®                  | Global Power Resource <sup>SM</sup>            | PowerTrench®                          | TinyBuck®        |
| AX-CAP®*                 | GreenBridge™                                   | PowerXS™                              | TinyCalc™        |
| BitSiC™                  | Green FPS™                                     | Programmable Active Droop™            | TinyLogic®       |
| Build it Now™            | Green FPS™ e-Series™                           | QFET®                                 | TINYOPTO™        |
| CorePLUS™                | Gmax™  | QS™                                   | TinyPower™       |
| CorePOWER™               | GTO™   | Quiet Series™                         | TinyPWM™         |
| CROSSVOL™                | IntelliMAX™                                    | RapidConfigure™                       | TinyWire™        |
| CTL™                     | ISOPLANAR™                                     | Saving our world, 1mW/W/kW at a time™ | TranSiC™         |
| Current Transfer Logic™  | Making Small Speakers Sound Louder and Better™ | SignalWise™                           | TriFault Detect™ |
| DEUXPEED®                | MegaBuck™                                      | SmartMax™                             | TRUECURRENT®*    |
| Dual Cool™               | MICROCOUPLER™                                  | SMART START™                          | μSerDes™         |
| EcoSPARK®                | MicroFET™                                      | Solutions for Your Success™           | UHC®             |
| EfficientMax™            | MicroPak™                                      | SPM®                                  | Ultra FRFET™     |
| ESBC™                    | MicroPak2™                                     | STEALTH™                              | UniFET™          |
| F <sup>®</sup>           | MillerDrive™                                   | SuperFET®                             | VCX™             |
| Fairchild®               | MotionMax™                                     | SuperSOT™-3                           | VisualMax™       |
| Fairchild Semiconductor® | MotionGrid®                                    | SuperSOT™-6                           | VoltagePlus™     |
| FACT Quiet Series™       | MTi®   | SuperSOT™-8                           | XST™             |
| FACT®                    | MTx®   | SupreMOS®                             | Xsens™           |
| FastvCore™               | MVN®   | SyncFET™                              | 仙童®              |
| FETBench™                | mWSaver®                                       | Sync-Lock™                            |                  |
| FPS™                     | OptoHiT™                                       |                                       |                  |
|                          | OPTOLOGIC®                                     |                                       |                  |

\* Trademarks of System General Corporation, used under license by Fairchild Semiconductor.

**DISCLAIMER**

FAIRCHILD SEMICONDUCTOR RESERVES THE RIGHT TO MAKE CHANGES WITHOUT FURTHER NOTICE TO ANY PRODUCTS HEREIN TO IMPROVE RELIABILITY, FUNCTION, OR DESIGN. TO OBTAIN THE LATEST, MOST UP-TO-DATE DATASHEET AND PRODUCT INFORMATION, VISIT OUR WEBSITE AT [HTTP://WWW.FAIRCHILDSEMI.COM](http://www.fairchildsemi.com). FAIRCHILD DOES NOT ASSUME ANY LIABILITY ARISING OUT OF THE APPLICATION OR USE OF ANY PRODUCT OR CIRCUIT DESCRIBED HEREIN; NEITHER DOES IT CONVEY ANY LICENSE UNDER ITS PATENT RIGHTS, NOR THE RIGHTS OF OTHERS. THESE SPECIFICATIONS DO NOT EXPAND THE TERMS OF FAIRCHILD'S WORLDWIDE TERMS AND CONDITIONS, SPECIFICALLY THE WARRANTY THEREIN, WHICH COVERS THESE PRODUCTS.

**AUTHORIZED USE**

Unless otherwise specified in this data sheet, this product is a standard commercial product and is not intended for use in applications that require extraordinary levels of quality and reliability. This product may not be used in the following applications, unless specifically approved in writing by a Fairchild officer: (1) automotive or other transportation, (2) military/aerospace, (3) any safety critical application – including life critical medical equipment – where the failure of the Fairchild product reasonably would be expected to result in personal injury, death or property damage. Customer's use of this product is subject to agreement of this Authorized Use policy. In the event of an unauthorized use of Fairchild's product, Fairchild accepts no liability in the event of product failure. In other respects, this product shall be subject to Fairchild's Worldwide Terms and Conditions of Sale, unless a separate agreement has been signed by both Parties.

**ANTI-COUNTERFEITING POLICY**

Fairchild Semiconductor Corporation's Anti-Counterfeiting Policy. Fairchild's Anti-Counterfeiting Policy is also stated on our external website, [www.fairchildsemi.com](http://www.fairchildsemi.com), under Terms of Use

Counterfeiting of semiconductor parts is a growing problem in the industry. All manufacturers of semiconductor products are experiencing counterfeiting of their parts. Customers who inadvertently purchase counterfeit parts experience many problems such as loss of brand reputation, substandard performance, failed applications, and increased cost of production and manufacturing delays. Fairchild is taking strong measures to protect ourselves and our customers from the proliferation of counterfeit parts. Fairchild strongly encourages customers to purchase Fairchild parts either directly from Fairchild or from Authorized Fairchild Distributors who are listed by country on our web page cited above. Products customers buy either from Fairchild directly or from Authorized Fairchild Distributors are genuine parts, have full traceability, meet Fairchild's quality standards for handling and storage and provide access to Fairchild's full range of up-to-date technical and product information. Fairchild and our Authorized Distributors will stand behind all warranties and will appropriately address any warranty issues that may arise. Fairchild will not provide any warranty coverage or other assistance for parts bought from Unauthorized Sources. Fairchild is committed to combat this global problem and encourage our customers to do their part in stopping this practice by buying direct or from authorized distributors.

**PRODUCT STATUS DEFINITIONS**

**Definition of Terms**

Datasheet Identification	Product Status	Definition
Advance Information	Formative / In Design	Datasheet contains the design specifications for product development. Specifications may change in any manner without notice.
Preliminary	First Production	Datasheet contains preliminary data; supplementary data will be published at a later date. Fairchild Semiconductor reserves the right to make changes at any time without notice to improve design.
No Identification Needed	Full Production	Datasheet contains final specifications. Fairchild Semiconductor reserves the right to make changes at any time without notice to improve the design.
Obsolete	Not In Production	Datasheet contains specifications on a product that is discontinued by Fairchild Semiconductor. The datasheet is for reference information only.



# Mouser Electronics

Authorized Distributor

Click to View Pricing, Inventory, Delivery & Lifecycle Information:

[Fairchild Semiconductor:](#)

[FJI5603DTU](#)