



Is Now Part of



**ON Semiconductor®**

To learn more about ON Semiconductor, please visit our website at  
[www.onsemi.com](http://www.onsemi.com)

ON Semiconductor and the ON Semiconductor logo are trademarks of Semiconductor Components Industries, LLC dba ON Semiconductor or its subsidiaries in the United States and/or other countries. ON Semiconductor owns the rights to a number of patents, trademarks, copyrights, trade secrets, and other intellectual property. A listing of ON Semiconductor's product/patent coverage may be accessed at [www.onsemi.com/site/pdf/Patent-Marking.pdf](http://www.onsemi.com/site/pdf/Patent-Marking.pdf). ON Semiconductor reserves the right to make changes without further notice to any products herein. ON Semiconductor makes no warranty, representation or guarantee regarding the suitability of its products for any particular purpose, nor does ON Semiconductor assume any liability arising out of the application or use of any product or circuit, and specifically disclaims any and all liability, including without limitation special, consequential or incidental damages. Buyer is responsible for its products and applications using ON Semiconductor products, including compliance with all laws, regulations and safety requirements or standards, regardless of any support or applications information provided by ON Semiconductor. "Typical" parameters which may be provided in ON Semiconductor data sheets and/or specifications can and do vary in different applications and actual performance may vary over time. All operating parameters, including "Typicals" must be validated for each customer application by customer's technical experts. ON Semiconductor does not convey any license under its patent rights nor the rights of others. ON Semiconductor products are not designed, intended, or authorized for use as a critical component in life support systems or any FDA Class 3 medical devices or medical devices with a same or similar classification in a foreign jurisdiction or any devices intended for implantation in the human body. Should Buyer purchase or use ON Semiconductor products for any such unintended or unauthorized application, Buyer shall indemnify and hold ON Semiconductor and its officers, employees, subsidiaries, affiliates, and distributors harmless against all claims, costs, damages, and expenses, and reasonable attorney fees arising out of, directly or indirectly, any claim of personal injury or death associated with such unintended or unauthorized use, even if such claim alleges that ON Semiconductor was negligent regarding the design or manufacture of the part. ON Semiconductor is an Equal Opportunity/Affirmative Action Employer. This literature is subject to all applicable copyright laws and is not for resale in any manner.

# FGA50N100BNTD2

## 1000 V NPT Trench IGBT

### Features

- High Speed Switching
- Low Saturation Voltage :  $V_{CE(sat)} = 2.5 \text{ V @ } I_C = 60 \text{ A}$
- High Input Impedance
- Built-in Fast Recovery Diode
- RoHS Compliant

### Applications

- UPS, Welder

### General Description

Using Fairchild's proprietary trench design and advanced NPT technology, the 1000V NPT IGBT offers superior conduction and switching performances, high avalanche ruggedness and easy parallel operation. This device offers the optimum performance for hard switching application such as UPS, welder applications.

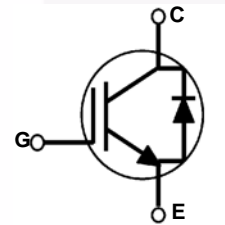
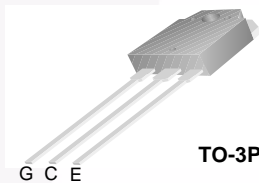

### Absolute Maximum Ratings

Symbol	Description	Ratings	Unit
$V_{CES}$	Collector to Emitter Voltage	1000	V
$V_{GES}$	Gate to Emitter Voltage	$\pm 25$	V
$I_C$	Collector Current @ $T_C = 25^\circ\text{C}$	50	A
	Collector Current @ $T_C = 100^\circ\text{C}$	35	A
$I_{CM(1)}$	Pulsed Collector Current	200	A
$I_F$	Diode Continuous Forward Current @ $T_C = 25^\circ\text{C}$	30	A
	Diode Continuous Forward Current @ $T_C = 100^\circ\text{C}$	15	A
$I_{FM}$	Diode Maximum Forward Current	150	A
$P_D$	Maximum Power Dissipation @ $T_C = 25^\circ\text{C}$	156	W
	Maximum Power Dissipation @ $T_C = 100^\circ\text{C}$	63	W
$T_J$	Operating Junction Temperature	-55 to +150	$^\circ\text{C}$
$T_{stg}$	Storage Temperature Range	-55 to +150	$^\circ\text{C}$
$T_L$	Maximum Lead Temp. for soldering Purposes, 1/8" from case for 5 seconds	300	$^\circ\text{C}$

**Notes:**

1: Repetitive rating : Pulse width limited by max. junction temperature

### Thermal Characteristics

Symbol	Parameter	Typ.	Max.	Unit
$R_{\theta JC}(\text{IGBT})$	Thermal Resistance, Junction to Case	-	0.8	$^\circ\text{C/W}$
$R_{\theta JC}(\text{DIODE})$	Thermal Resistance, Junction to Case	-	1.2	$^\circ\text{C/W}$
$R_{\theta JA}$	Thermal Resistance, Junction to Ambient	-	40.0	$^\circ\text{C/W}$

## Package Marking and Ordering Information

Part Number	Top Mark	Package	Packing Method	Reel Size	Tape Width	Quantity
FGA50N100BNTD2	FGA50N100BNTD2	TO-3P	Tube	N/A	N/A	30

## Electrical Characteristics of the IGBT T<sub>C</sub> = 25°C unless otherwise noted

Symbol	Parameter	Test Conditions	Min.	Typ.	Max.	Unit
<b>Off Characteristics</b>						
$V_{CES}$	Collector to Emitter Breakdown Voltage	$V_{GE} = 0\text{ V}, I_C = 1\text{ mA}$	1000	-	-	V
$I_{CES}$	Collector Cut-Off Current	$V_{CE} = 1000\text{ V}, V_{GE} = 0\text{ V}$	-	-	1.0	mA
$I_{GES}$	G-E Leakage Current	$V_{GE} = \pm 25\text{ V}, V_{CE} = 0\text{ V}$	-	-	$\pm 500$	nA
<b>On Characteristics</b>						
$V_{GE(th)}$	G-E Threshold Voltage	$I_C = 60\text{ mA}, V_{CE} = V_{GE}$	4.0	5.5	7.0	V
$V_{CE(sat)}$	Collector to Emitter Saturation Voltage	$I_C = 10\text{ A}, V_{GE} = 15\text{ V}$	-	1.5	1.8	V
		$I_C = 60\text{ A}, V_{GE} = 15\text{ V}$	-	2.5	2.9	V
		$I_C = 60\text{ A}, V_{GE} = 15\text{ V}, T_C = 125^\circ\text{C}$	-	3.3	-	V
<b>Dynamic Characteristics</b>						
$C_{ies}$	Input Capacitance	$V_{CE} = 10\text{ V}, V_{GE} = 0\text{ V}, f = 1\text{ MHz}$	-	6000	-	pF
$C_{oes}$	Output Capacitance		-	260	-	pF
$C_{res}$	Reverse Transfer Capacitance		-	200	-	pF
<b>Switching Characteristics</b>						
$t_{d(on)}$	Turn-On Delay Time	$V_{CC} = 600\text{ V}, I_C = 60\text{ A}, R_G = 10\ \Omega, V_{GE} = 15\text{ V}, \text{Inductive Load}, T_C = 25^\circ\text{C}$	-	34	-	ns
$t_r$	Rise Time		-	68	-	ns
$t_{d(off)}$	Turn-Off Delay Time		-	243	-	ns
$t_f$	Fall Time		-	65	100	ns
$Q_g$	Total Gate Charge	$V_{CE} = 600\text{ V}, I_C = 60\text{ A}, V_{GE} = 15\text{ V}, T_C = 25^\circ\text{C}$	-	257	350	nC
$Q_{ge}$	Gate to Emitter Charge		-	45	-	nC
$Q_{gc}$	Gate to Collector Charge		-	95	-	nC

## Electrical Characteristics of the Diode T<sub>C</sub> = 25°C unless otherwise noted

$V_{FM}$	Diode Forward Voltage	$I_F = 15\text{ A}$	-	2.9	3.2	V
		$I_F = 60\text{ A}$	-	4.0	4.7	V
$t_{rr}$	Diode Reverse Recovery Time	$I_F = 60\text{ A}, di_F/dt = 100\text{ A/us}$	-	60	75	ns
$I_R$	Instantaneous Reverse Current	$V_{RRM} = 1000\text{ V}$	-	-	2	$\mu\text{A}$

## Typical Performance Characteristics

Figure 1. Typical Output Characteristics

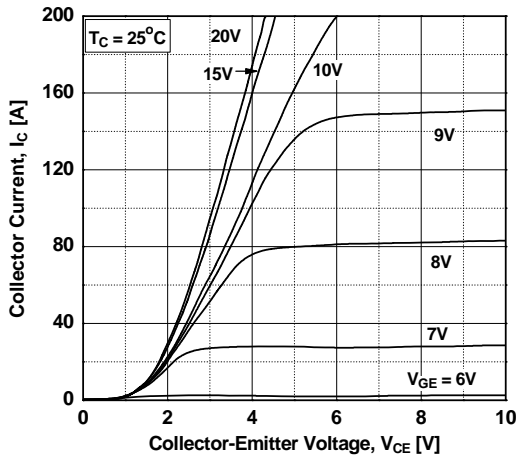

Figure 2. Typical Output Characteristics

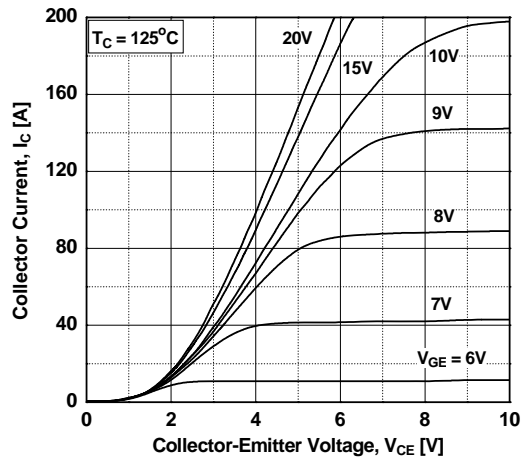

Figure 3. Typical Saturation Voltage Characteristics

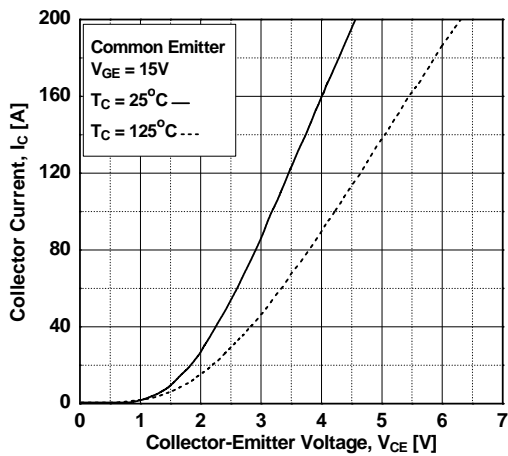

Figure 4. Transfer Characteristics

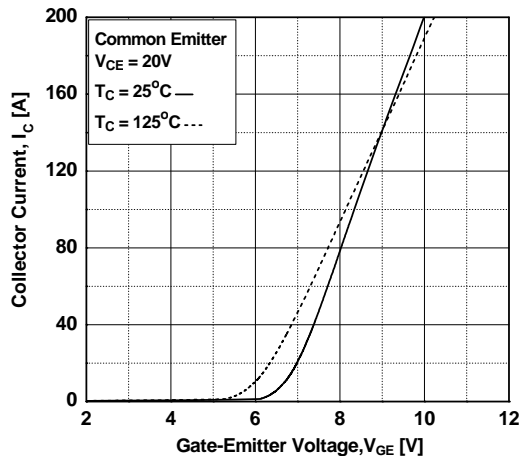

Figure 5. Saturation Voltage vs. Case Temperature at Variant Current Level

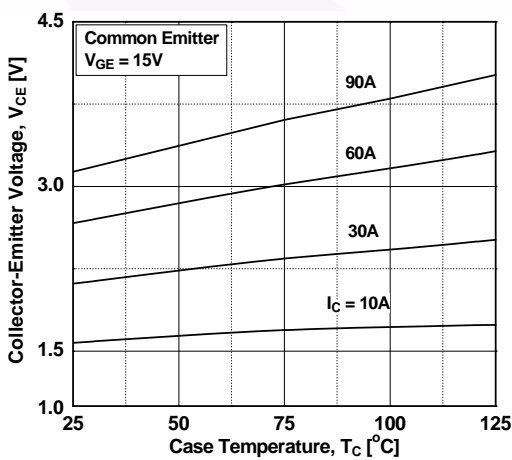
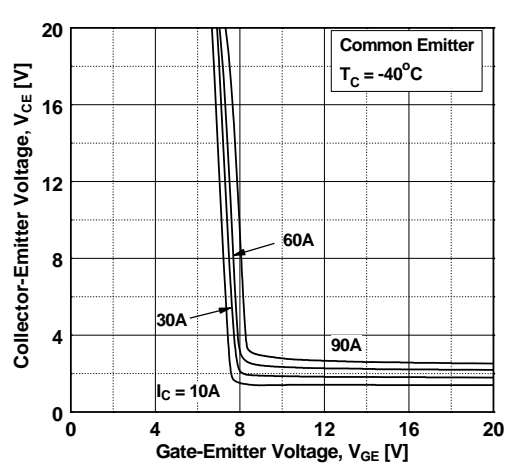

Figure 6. Saturation Voltage vs. Vge



## Typical Performance Characteristics

Figure 7. Saturation Voltage vs.  $V_{GE}$

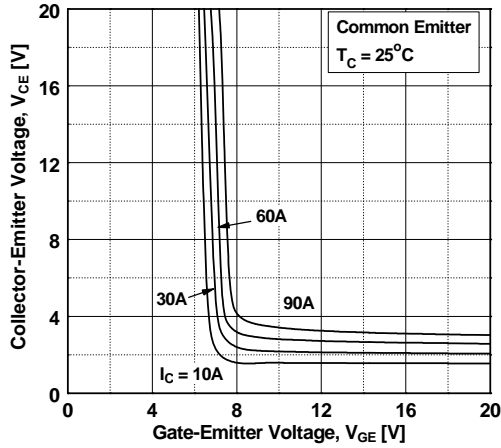

Figure 8. Saturation Voltage vs.  $V_{GE}$

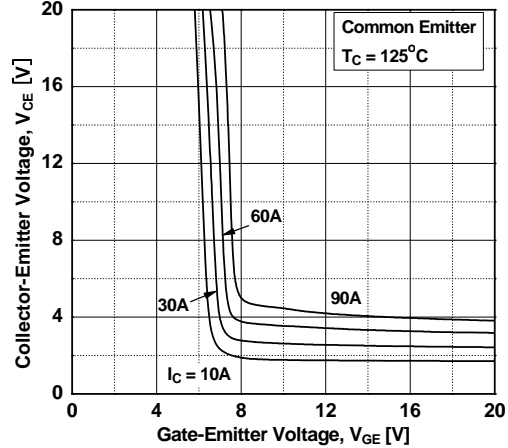

Figure 9. Capacitance Characteristics

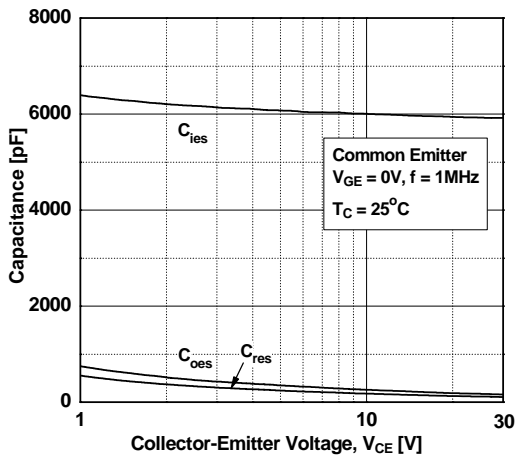

Figure 10. Gate charge Characteristics

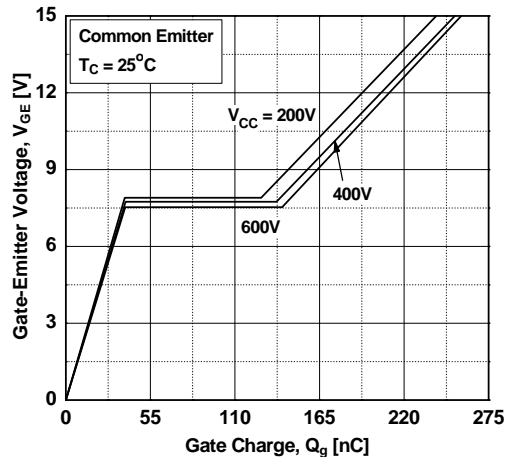

Figure 11. SOA Characteristics

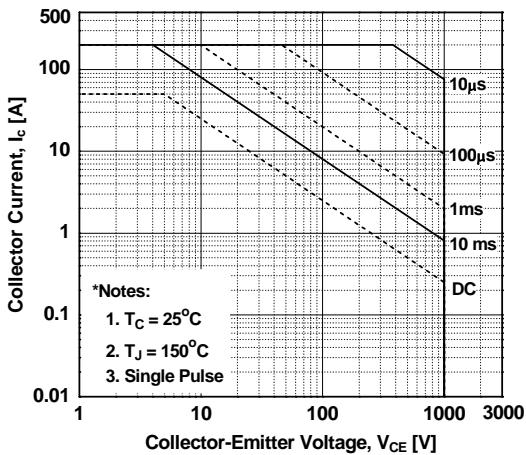
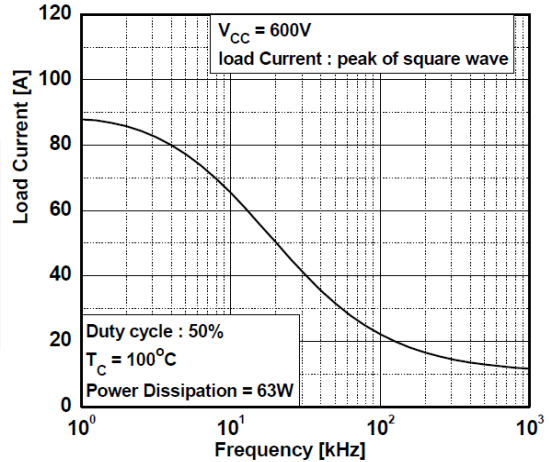
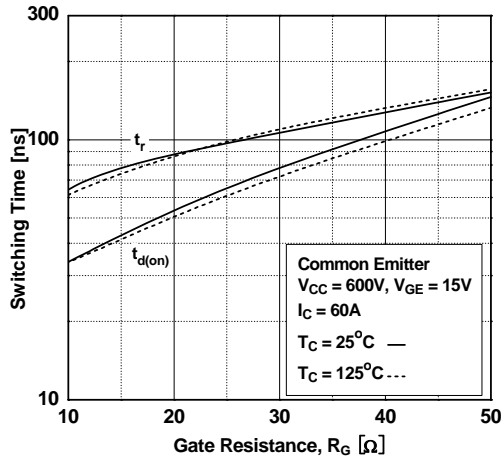

Figure 12. Load Current vs. Frequency



## Typical Performance Characteristics

**Figure 13. Turn-on Characteristics vs. Gate Resistance**



**Figure 14. Turn-off Characteristics vs. Gate Resistance**

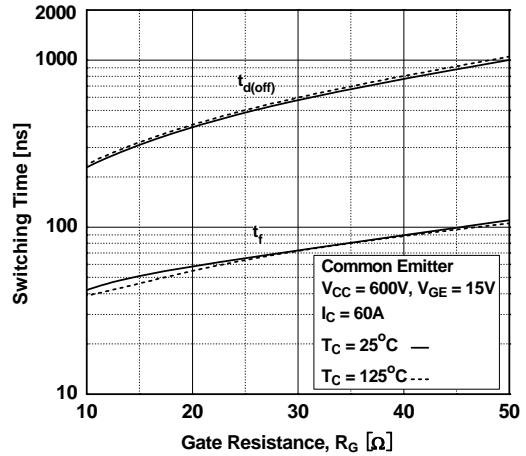

**Figure 15. Turn-on Characteristics vs. Collector Current**

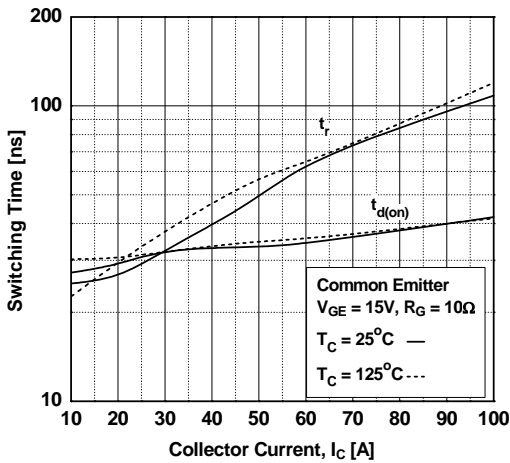

**Figure 16. Turn-off Characteristics vs. Collector Current**

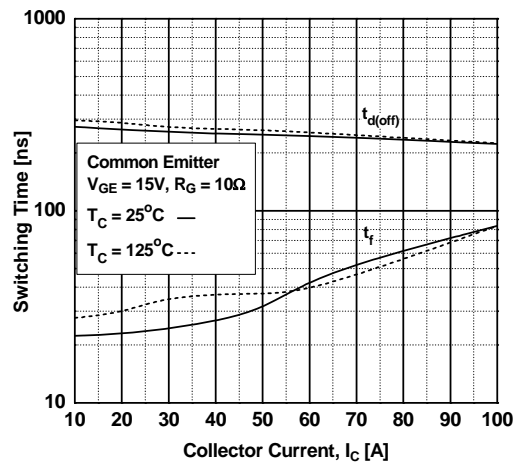

**Figure 17. Switching Loss vs. Gate Resistance**

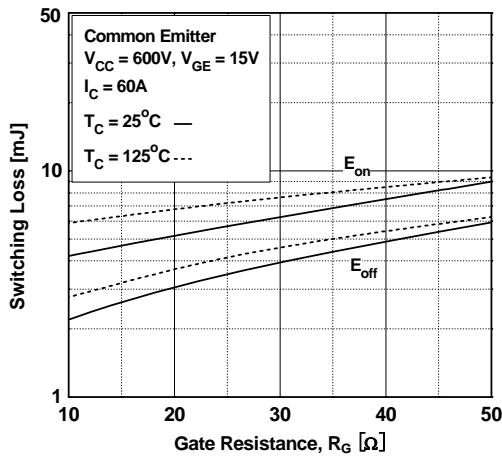

**Fig 18. Switching Loss vs. Collector Current**

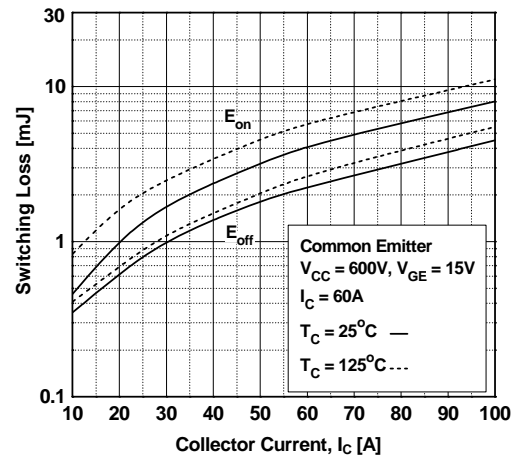

## Typical Performance Characteristics

Figure 19. Turn off Switching SOA Characteristics

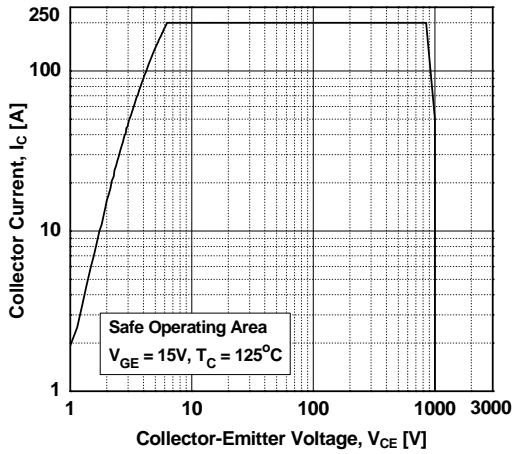

Figure 20. Forward Characteristics

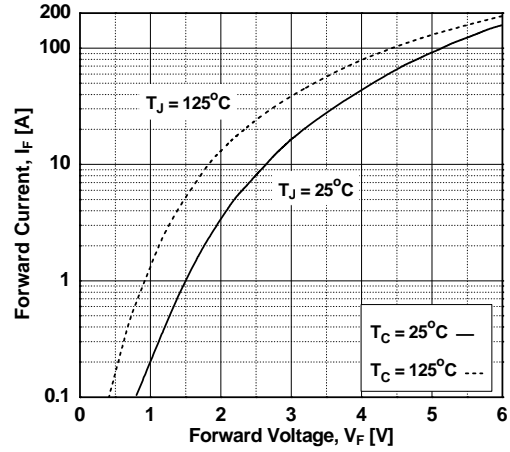

Figure 21. Reverse Current

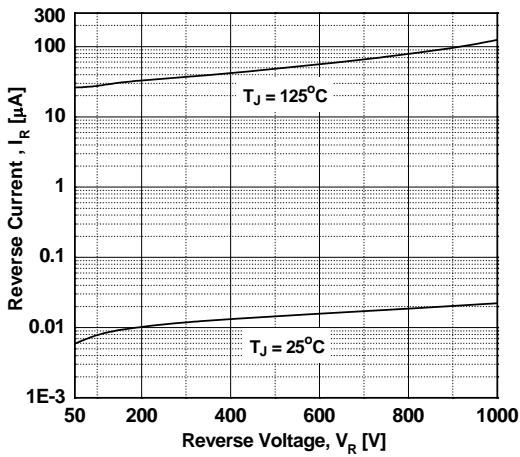

Figure 22. Reverse Recovery Characteristics vs.  $di_F/dt$

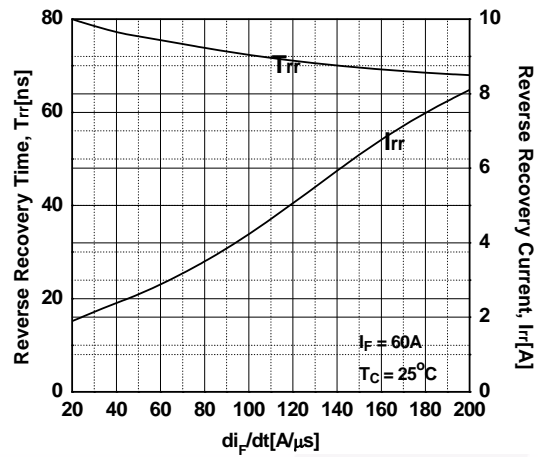
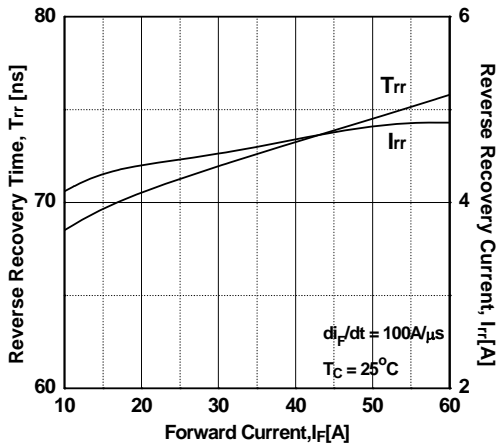
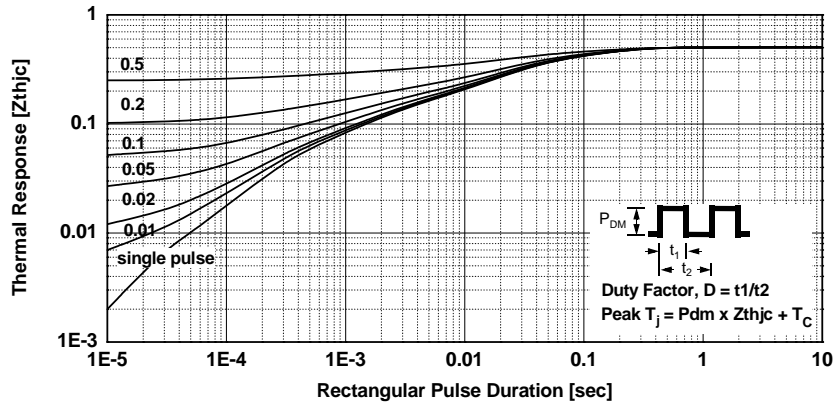

Figure 23. Reverse Recovery Characteristics vs. Forward Current



Typical Performance Characteristics

Figure 24. Transient Thermal Impedance of IGBT





**Mechanical Dimensions**

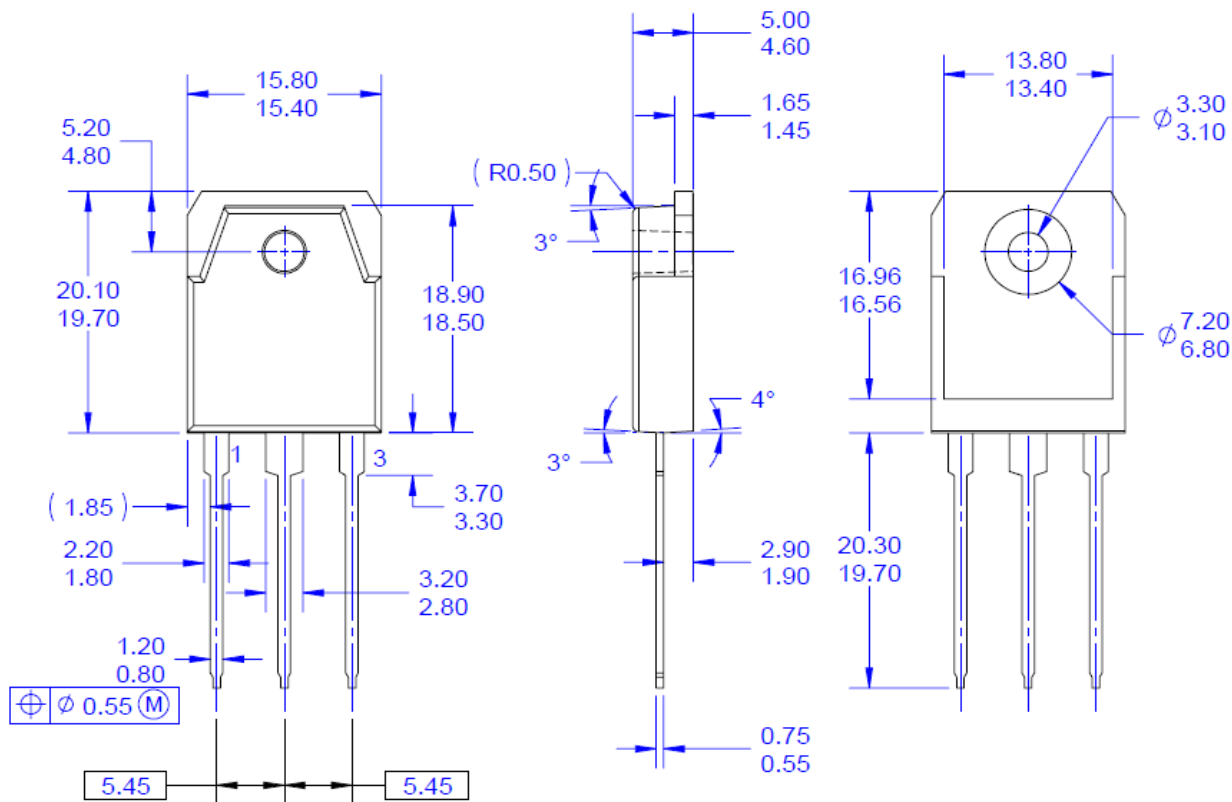

NOTES: UNLESS OTHERWISE SPECIFIED

- A) THIS PACKAGE CONFORMS TO EIAJ SC-65 PACKAGING STANDARD.
- B) ALL DIMENSIONS ARE IN MILLIMETERS.
- C) DIMENSION AND TOLERANCING PER ASME14.5
- D) DIMENSIONS ARE EXCLUSIVE OF BURRS, MOLD FLASH, AND TIE BAR EXTRUSIONS.
- E) THIS PACKAGE IS INTENDED ONLY FOR T03PN.
- F) DRAWING FILE NAME: TO3P03AREV4.

**Figure 25. TO-3P 3L - 3LD, T03, PLASTIC, EIAJ SC-65**



Package drawings are provided as a service to customers considering Fairchild components. Drawings may change in any manner without notice. Please note the revision and/or date on the drawing and contact a Fairchild Semiconductor representative to verify or obtain the most recent revision. Package specifications do not expand the terms of Fairchild's worldwide terms and conditions, specifically the warranty therein, which covers Fairchild products.

Always visit Fairchild Semiconductor's online packaging area for the most recent package drawings:

[http://www.fairchildsemi.com/package/packageDetails.html?id=PN\\_TT3P0-003](http://www.fairchildsemi.com/package/packageDetails.html?id=PN_TT3P0-003)

**TRADEMARKS**

The following includes registered and unregistered trademarks and service marks, owned by Fairchild Semiconductor and/or its global subsidiaries, and is not intended to be an exhaustive list of all such trademarks.

- |   |   |                            |   |
|---|---|----------------------------|---|
| AccuPower™  | F-PFST™   | PowerTrench®               | Sync-Lock™  |
| AX-CAP®*  | FRFET®  | PowerXS™                   | SYSTEM GENERAL®*  |
| BitSiC™   | Global Power Resource <sup>SM</sup>             | Programmable Active Droop™ | TinyBoost®  |
| Build it Now™   | GreenBridge™                                    | QFET®                      | TinyBuck™   |
| CorePLUS™   | Green FPS™                                      | QS™                        | TinyCalc™   |
| CorePOWER™  | Green FPS™ e-Series™                            | Quiet Series™              | TinyLogic®  |
| CROSSVOLT™  | Gmax™   | RapidConfigure™            | TINYOPTO™   |
| CTL™  | GTO™  |                            | TinyPower™  |
| Current Transfer Logic™   | IntelliMAX™                                     |                            | TinyPWM™  |
| DEUXPEED®   | ISOPLANAR™                                      |                            | TinyWire™   |
| Dual Cool™  | Marking Small Speakers Sound Louder and Better™ |                            | TranSiC™  |
| EcoSPARK®   | MegaBuck™                                       |                            | TriFault Detect™  |
| EfficientMax™   | MICROCOUPLER™                                   |                            | TRUECURRENT®*   |
| ESBC™   | MicroFET™                                       |                            | µSerDes™  |
|  | MicroPak™                                       |                            |  |
| Fairchild®  | MicroPak2™                                      |                            | UHC®  |
| Fairchild Semiconductor®  | MillerDrive™                                    |                            | Ultra FRFET™  |
| FACT Quiet Series™  | MotionMax™                                      |                            | UniFET™   |
| FACT®   | mWSaver®  |                            | VCX™  |
| FAST®   | OptoHiT™  |                            | VisualMax™  |
| FastvCore™  | OPTOLOGIC®                                      |                            | VoltagePlus™  |
| FETBench™   | OPTOPLANAR®                                     |                            | XS™   |
| FPS™  |   |                            |   |

\*Trademarks of System General Corporation, used under license by Fairchild Semiconductor.

**DISCLAIMER**

FAIRCHILD SEMICONDUCTOR RESERVES THE RIGHT TO MAKE CHANGES WITHOUT FURTHER NOTICE TO ANY PRODUCTS HEREIN TO IMPROVE RELIABILITY, FUNCTION, OR DESIGN. FAIRCHILD DOES NOT ASSUME ANY LIABILITY ARISING OUT OF THE APPLICATION OR USE OF ANY PRODUCT OR CIRCUIT DESCRIBED HEREIN; NEITHER DOES IT CONVEY ANY LICENSE UNDER ITS PATENT RIGHTS, NOR THE RIGHTS OF OTHERS. THESE SPECIFICATIONS DO NOT EXPAND THE TERMS OF FAIRCHILD'S WORLDWIDE TERMS AND CONDITIONS, SPECIFICALLY THE WARRANTY THEREIN, WHICH COVERS THESE PRODUCTS.

**LIFE SUPPORT POLICY**

FAIRCHILD'S PRODUCTS ARE NOT AUTHORIZED FOR USE AS CRITICAL COMPONENTS IN LIFE SUPPORT DEVICES OR SYSTEMS WITHOUT THE EXPRESS WRITTEN APPROVAL OF FAIRCHILD SEMICONDUCTOR CORPORATION.

As used here in:

- Life support devices or systems are devices or systems which, (a) are intended for surgical implant into the body or (b) support or sustain life, and (c) whose failure to perform when properly used in accordance with instructions for use provided in the labeling, can be reasonably expected to result in a significant injury of the user.
- A critical component in any component of a life support, device, or system whose failure to perform can be reasonably expected to cause the failure of the life support device or system, or to affect its safety or effectiveness.

**ANTI-COUNTERFEITING POLICY**

Fairchild Semiconductor Corporation's Anti-Counterfeiting Policy. Fairchild's Anti-Counterfeiting Policy is also stated on our external website, [www.fairchildsemi.com](http://www.fairchildsemi.com), under Sales Support. Counterfeiting of semiconductor parts is a growing problem in the industry. All manufactures of semiconductor products are experiencing counterfeiting of their parts. Customers who inadvertently purchase counterfeit parts experience many problems such as loss of brand reputation, substandard performance, failed application, and increased cost of production and manufacturing delays. Fairchild is taking strong measures to protect ourselves and our customers from the proliferation of counterfeit parts. Fairchild strongly encourages customers to purchase Fairchild parts either directly from Fairchild or from Authorized Fairchild Distributors who are listed by country on our web page cited above. Products customers buy either from Fairchild directly or from Authorized Fairchild Distributors are genuine parts, have full traceability, meet Fairchild's quality standards for handling and storage and provide access to Fairchild's full range of up-to-date technical and product information. Fairchild and our Authorized Distributors will stand behind all warranties and will appropriately address and warranty issues that may arise. Fairchild will not provide any warranty coverage or other assistance for parts bought from Unauthorized Sources. Fairchild is committed to combat this global problem and encourage our customers to do their part in stopping this practice by buying direct or from authorized distributors.

**PRODUCT STATUS DEFINITIONS**

Definition of Terms

Datasheet Identification	Product Status	Definition
Advance Information	Formative / In Design	Datasheet contains the design specifications for product development. Specifications may change in any manner without notice.
Preliminary	First Production	Datasheet contains preliminary data; supplementary data will be published at a later date. Fairchild Semiconductor reserves the right to make changes at any time without notice to improve design.
No Identification Needed	Full Production	Datasheet contains final specifications. Fairchild Semiconductor reserves the right to make changes at any time without notice to improve the design.
Obsolete	Not In Production	Datasheet contains specifications on a product that is discontinued by Fairchild Semiconductor. The datasheet is for reference information only.

Rev. I66

# Mouser Electronics

Authorized Distributor

Click to View Pricing, Inventory, Delivery & Lifecycle Information:

[Fairchild Semiconductor:](#)

[FGA50N100BNTD2](#)