



# FDMB2308PZ

## Dual Common Drain P-Channel PowerTrench<sup>®</sup> MOSFET -20 V, -7 A, 36 mΩ

### Features

- Max  $r_{S1S2(on)}$  = 36 mΩ at  $V_{GS} = -4.5$  V,  $I_D = -5.7$  A
- Max  $r_{S1S2(on)}$  = 50 mΩ at  $V_{GS} = -2.5$  V,  $I_D = -4.6$  A
- Low Profile - 0.8 mm maximum - in the new package MicroFET 2x3 mm
- HBM ESD protection level 2.8 kV (Note 3)
- RoHS Compliant

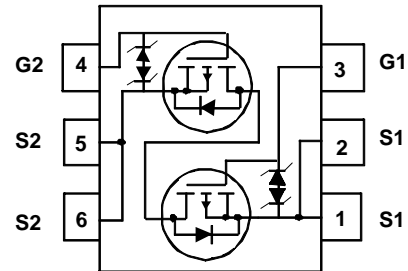
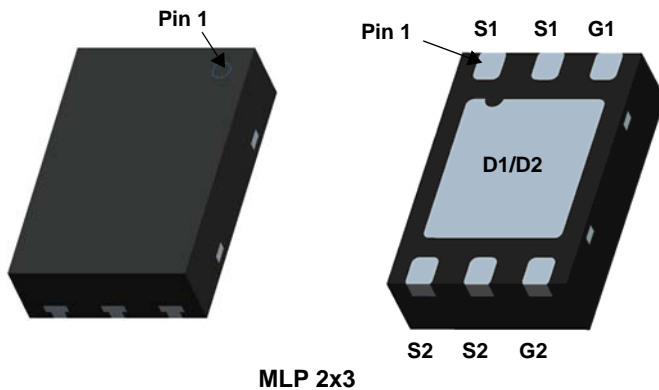


### General Description

This device is designed specifically as a single package solution for Li-Ion battery pack protection circuit and other ultra-portable applications. It features two common drain P-channel MOSFETs, which enables bidirectional current flow, on Fairchild's advanced PowerTrench<sup>®</sup> process with state of the art MircoFET Leadframe, the FDMB2308PZ minimizes both PCB space and  $r_{S1S2(on)}$ .

### Application

- Li-Ion Battery Pack



### MOSFET Maximum Ratings $T_A = 25$ °C unless otherwise noted

Symbol	Parameter	Ratings	Units
$V_{S1S2}$	Source1 to Source2 Voltage	-20	V
$V_{GS}$	Gate to Source Voltage	±12	V
$I_{S1S2}$	Source1 to Source2 Current -Continuous $T_A = 25$ °C (Note 1a)	-7	A
	-Pulsed	-30	
$P_D$	Power Dissipation $T_A = 25$ °C (Note 1a)	2.2	W
	Power Dissipation $T_A = 25$ °C (Note 1b)	0.8	
$T_J, T_{STG}$	Operating and Storage Junction Temperature Range	-55 to +150	°C

### Thermal Characteristics

$R_{\theta JA}$	Thermal Resistance, Junction to Ambient	(Note 1a)	57	°C/W
$R_{\theta JA}$	Thermal Resistance, Junction to Ambient	(Note 1b)	161	

### Package Marking and Ordering Information

Device Marking	Device	Package	Reel Size	Tape Width	Quantity
308	FDMB2308PZ	MLP 2x3	7"	8 mm	3000 units

## Electrical Characteristics $T_J = 25\text{ }^\circ\text{C}$ unless otherwise noted

Symbol	Parameter	Test Conditions	Min	Typ	Max	Units
--------	-----------	-----------------	-----	-----	-----	-------

### Off Characteristics

$I_{S1S2}$	Zero Gate Voltage Source1 to Source2 Current	$V_{S1S2} = -16\text{ V}$ , $V_{GS} = 0\text{ V}$			-1	$\mu\text{A}$
$I_{GSS}$	Gate to Source Leakage Current	$V_{GS} = \pm 12\text{ V}$ , $V_{S1S2} = 0\text{ V}$			$\pm 10$	$\mu\text{A}$

### On Characteristics

$V_{GS(th)}$	Gate to Source Threshold Voltage	$V_{GS} = V_{S1S2}$ , $I_{S1S2} = -250\text{ }\mu\text{A}$	-0.6	-0.9	-1.5	V
$r_{S1S2(on)}$	Static Source1 to Source2 On Resistance	$V_{GS} = -4.5\text{ V}$ , $I_{S1S2} = -5.7\text{ A}$		27	36	m $\Omega$
		$V_{GS} = -2.5\text{ V}$ , $I_{S1S2} = -4.6\text{ A}$		36	50	
		$V_{GS} = -4.5\text{ V}$ , $I_{S1S2} = -5.7\text{ A}$ , $T_J = 125\text{ }^\circ\text{C}$		35	49	
$g_{FS}$	Forward Transconductance	$V_{S1S2} = -5\text{ V}$ , $I_{S1S2} = -5.7\text{ A}$		29		S

### Dynamic Characteristics

$C_{iss}$	Input Capacitance	$V_{S1S2} = -10\text{ V}$ , $V_{GS} = 0\text{ V}$ , $f = 1\text{ MHz}$		2280	3030	pF
$C_{oss}$	Output Capacitance			361	540	pF
$C_{rss}$	Reverse Transfer Capacitance			339	510	pF

### Switching Characteristics

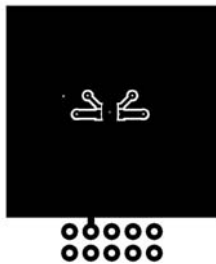
$t_{d(on)}$	Turn-On Delay Time	$V_{S1S2} = -10\text{ V}$ , $I_{S1S2} = -5.7\text{ A}$ $V_{GS} = -4.5\text{ V}$ , $R_{GEN} = 6\text{ }\Omega$		14	25	ns
$t_r$	Rise Time			33	52	ns
$t_{d(off)}$	Turn-Off Delay Time			74	118	ns
$t_f$	Fall Time			58	93	ns
$Q_g$	Total Gate Charge		$V_{S1S2} = -10\text{ V}$ , $I_{S1S2} = -5.7\text{ A}$ , $V_{G1S1} = -4.5\text{ V}$ , $V_{G2S2} = 0\text{ V}$		22	30
$Q_{gs}$	Gate1 to Source1 Charge			3.6		nC
$Q_{gd}$	Gate1 to Source2 "Miller" Charge			7.7		nC

### Source1- Source2 Diode Characteristics

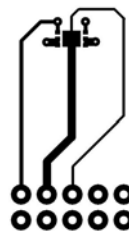
$I_{fss}$	Maximum Continuous Source1-Source2 Diode Forward Current				-5.7	A
$V_{fss}$	Source1 to Source2 Diode Forward Voltage	$V_{G1S1} = 0\text{ V}$ , $V_{G2S2} = -4.5\text{ V}$ , $I_{fss} = -5.7\text{ A}$ (Note 2)		-1	-1.6	V

#### NOTES:

1.  $R_{\theta JA}$  is determined with the device mounted on a 1 in<sup>2</sup> pad 2 oz copper pad on a 1.5 x 1.5 in. board of FR-4 material.  $R_{\theta JC}$  is guaranteed by design while  $R_{\theta CA}$  is determined by the user's board design.



a. 57  $^\circ\text{C/W}$  when mounted on a 1 in<sup>2</sup> pad of 2 oz copper

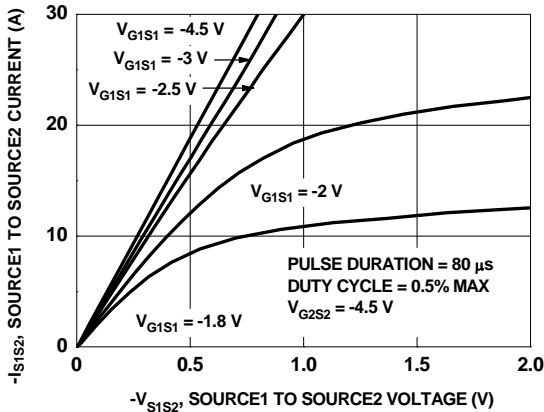


b. 161  $^\circ\text{C/W}$  when mounted on a minimum pad of 2 oz copper

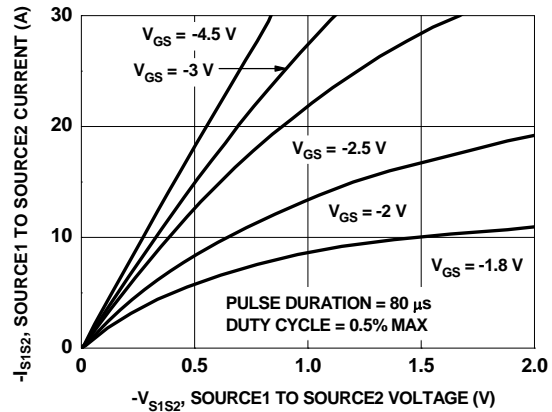
2. Pulse Test: Pulse Width < 300  $\mu\text{s}$ , Duty cycle < 2.0%.

3. The diode connected between the gate and source serves only as protection against ESD. No gate overvoltage rating is implied.

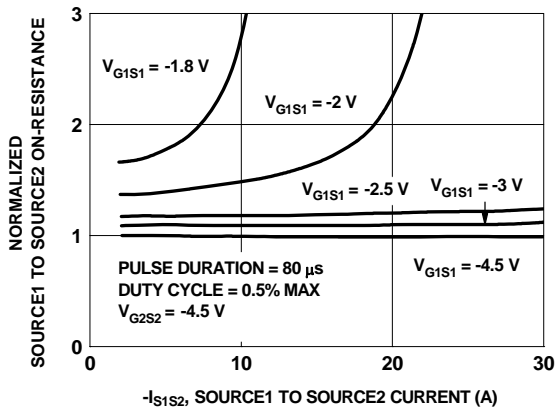
**Typical Characteristics**  $T_J = 25\text{ }^\circ\text{C}$  unless otherwise noted



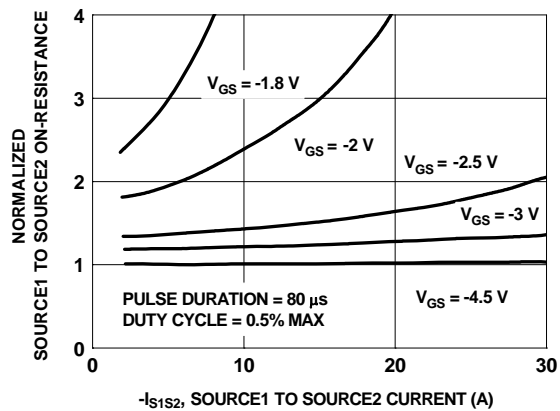
**Figure 1. On-Region Characteristics**



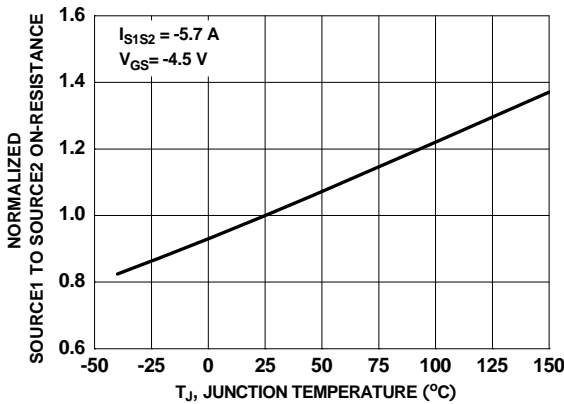
**Figure 2. On-Region Characteristics**



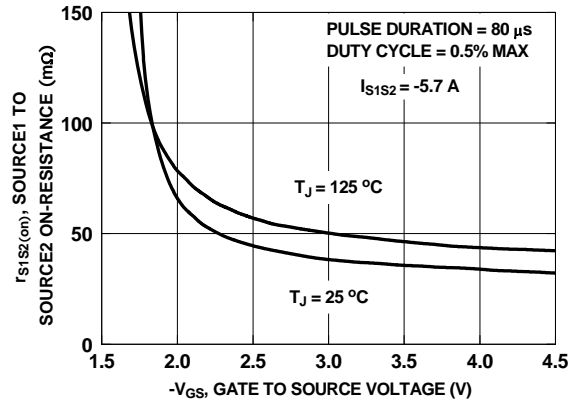
**Figure 3. Normalized On-Resistance vs Source1 to Source2 Current and Gate Voltage**



**Figure 4. Normalized On-Resistance vs Source1 to Source2 Current and Gate Voltage**

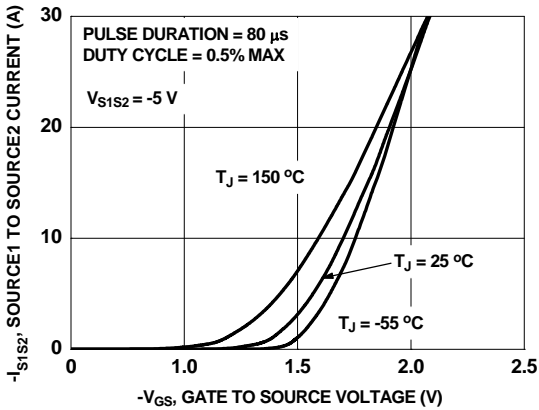


**Figure 5. Normalized On Resistance vs Junction Temperature**

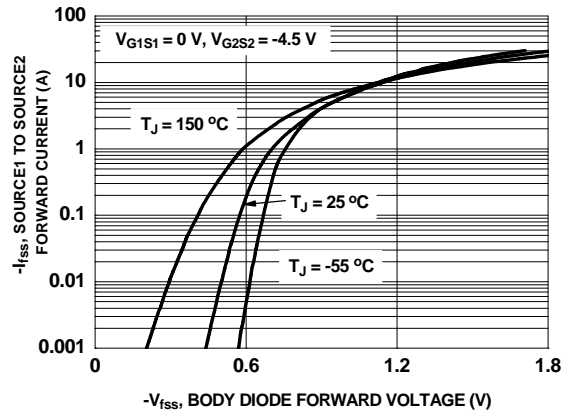


**Figure 6. On Resistance vs Gate to Source Voltage**

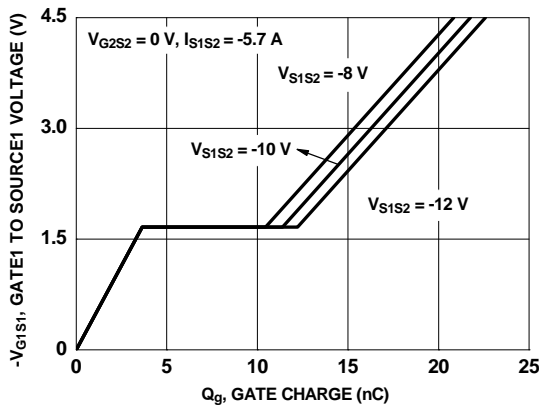
**Typical Characteristics**  $T_J = 25\text{ }^\circ\text{C}$  unless otherwise noted



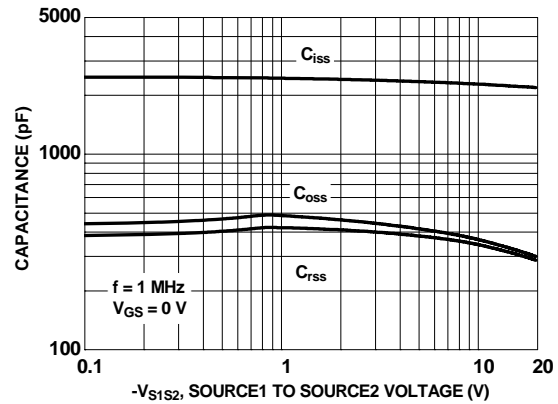
**Figure 7. Transfer Characteristics**



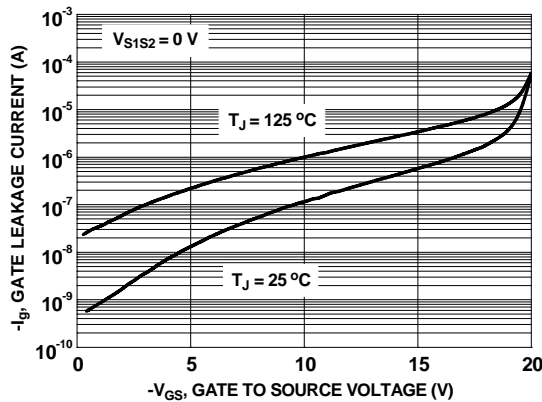
**Figure 8. Source1 to Source2 Diode Forward Voltage vs Source Current**



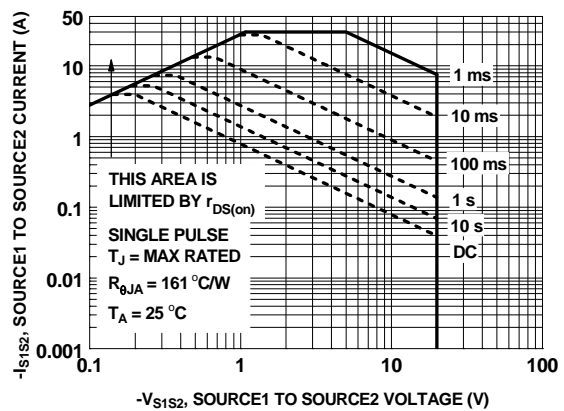
**Figure 9. Gate Charge Characteristics**



**Figure 10. Capacitance vs Source1 to Source2 Voltage**



**Figure 11. Gate Leakage Current vs Gate to Source Voltage**



**Figure 12. Forward Bias Safe Operating Area**

**Typical Characteristics**  $T_J = 25\text{ }^\circ\text{C}$  unless otherwise noted

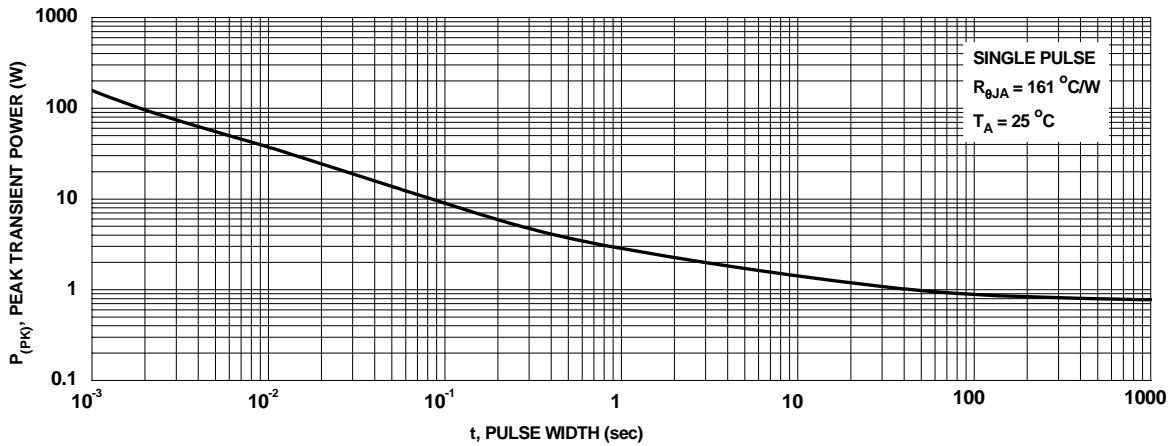


Figure 13. Single Pulse Maximum Power Dissipation

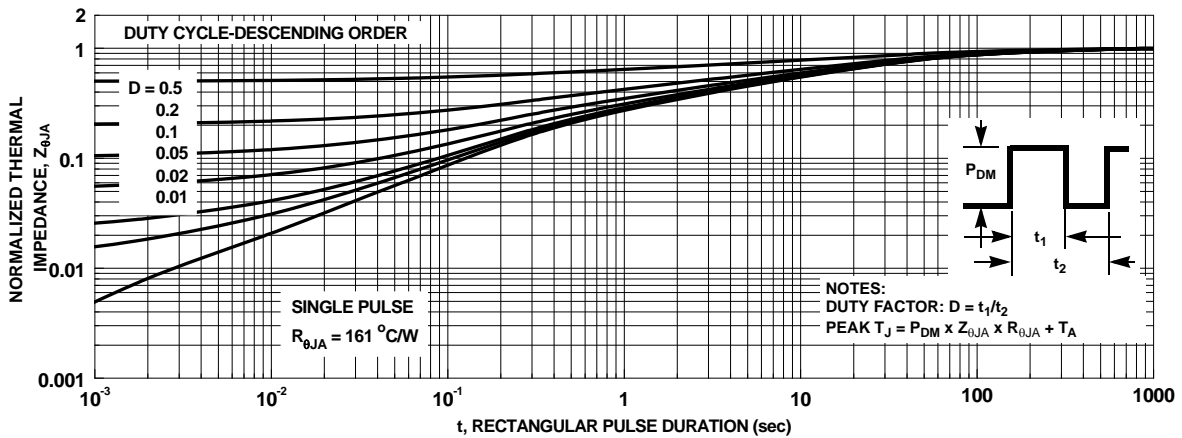
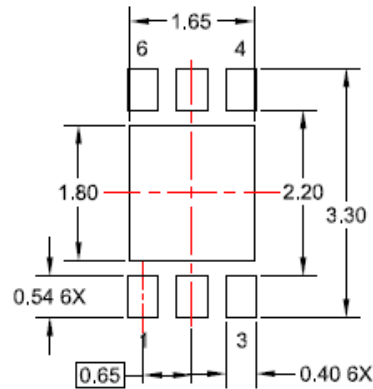
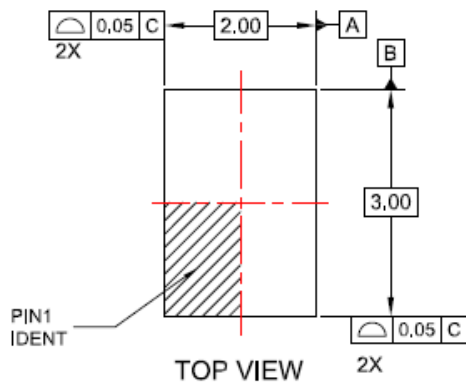
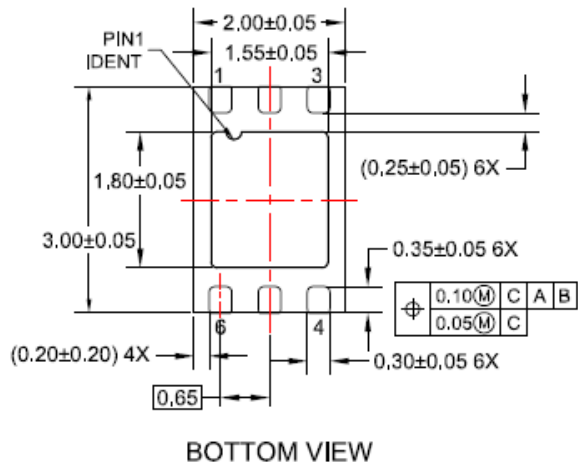
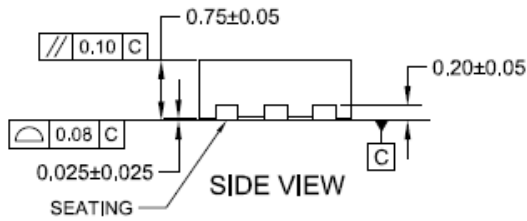


Figure 14. Junction-to-Ambient Transient Thermal Response Curve

## Dimensional Outline and Pad Layout



RECOMMENDED LAND PATTERN



### NOTES:

- A. PACKAGE CONFORMS TO JEDEC MO-229 EXCEPT WHERE NOTED.
- B. DRAWING FILENAME: MKT-MLP06Qrev3.
- C. DIMENSIONS AND TOLERANCES PER ASME Y14.5M, 2009.
- D. LAND PATTERN RECOMMENDATION IS EXISTING INDUSTRY LAND PATTERN.
- E. DIMENSIONS ARE IN MILLIMETERS.
- F. REFERENCE DIMENSIONS ARE UNCONTROLLED




Package drawings are provided as a service to customers considering Fairchild components. Drawings may change in any manner without notice. Please note the revision and/or date on the drawing and contact a Fairchild Semiconductor representative to verify or obtain the most recent revision. Package specifications do not expand the terms of Fairchild's worldwide terms and conditions, specifically the warranty therein, which covers Fairchild products.

Always visit Fairchild Semiconductor's online packaging area for the most recent package drawings:  
[http://www.fairchildsemi.com/package/packageDetails.html?id=PN\\_MLDEA-C06](http://www.fairchildsemi.com/package/packageDetails.html?id=PN_MLDEA-C06)



**TRADEMARKS**

The following includes registered and unregistered trademarks and service marks, owned by Fairchild Semiconductor and/or its global subsidiaries, and is not intended to be an exhaustive list of all such trademarks.

- |   |   |                                       |                  |
|---|---|---------------------------------------|------------------|
| AccuPower™  | F-PFST™   | PowerTrench®                          | SYSTEM®          |
| AX-CAP®*  | FRFET®  | PowerXS™                              | TinyBoost®       |
| BitSiC™   | Global Power Resource <sup>SM</sup>             | Programmable Active Droop™            | TinyBuck®        |
| Build it Now™   | GreenBridge™                                    | QFET®                                 | TinyCalc™        |
| CorePLUS™   | Green FPS™                                      | QS™                                   | TinyLogic™       |
| CorePOWER™  | Green FPS™ e-Series™                            | Quiet Series™                         | TINYOPTO™        |
| CROSSVOLT™  | Gmax™   | RapidConfigu™                         | TinyPower™       |
| CTL™  | GTO™  | Saving our world, 1mW/W/kW at a time™ | TinyPWM™         |
| Current Transfer Logic™   | IntelliMAX™                                     | SignalWise™                           | TinyWire™        |
| DEUXPEED®   | ISOPLANAR™                                      | SmartMax™                             | TranSiC™         |
| Dual Cool™  | Marking Small Speakers Sound Louder and Better™ | SMART START™                          | TriFault Detect™ |
| EcoSPARK®   | MegaBuck™                                       | SPM®                                  | TRUECURRENT®*    |
| EfficientMax™   | MICROCOUPLER™                                   | Solutions for Your Success™           | μSerDes™         |
| ESBC™   | MicroFET™                                       | STEALTH™                              | UHC®             |
|  | MicroPak™                                       | SuperFET®                             | Ultra FRFET™     |
| Fairchild®  | MicroPak2™                                      | SuperSOT™-3                           | UniFET™          |
| Fairchild Semiconductor®  | MillerDrive™                                    | SuperSOT™-6                           | VCX™             |
| FACT Quiet Series™  | MotionMax™                                      | SuperSOT™-8                           | VisualMax™       |
| FACT®   | mWSaver®  | SupreMOS®                             | VoltagePlus™     |
| FAST®   | OptoHiT™  | SyncFET™                              | XST™             |
| FastvCore™  | OPTOLOGIC®                                      | Sync-Lock™                            | 仙童™              |
| FETBench™   | OPTOPLANAR®                                     |                                       |                  |
| FPS™  |   |                                       |                  |

\*Trademarks of System General Corporation, used under license by Fairchild Semiconductor.

**DISCLAIMER**

FAIRCHILD SEMICONDUCTOR RESERVES THE RIGHT TO MAKE CHANGES WITHOUT FURTHER NOTICE TO ANY PRODUCTS HEREIN TO IMPROVE RELIABILITY, FUNCTION, OR DESIGN. FAIRCHILD DOES NOT ASSUME ANY LIABILITY ARISING OUT OF THE APPLICATION OR USE OF ANY PRODUCT OR CIRCUIT DESCRIBED HEREIN; NEITHER DOES IT CONVEY ANY LICENSE UNDER ITS PATENT RIGHTS, NOR THE RIGHTS OF OTHERS. THESE SPECIFICATIONS DO NOT EXPAND THE TERMS OF FAIRCHILD'S WORLDWIDE TERMS AND CONDITIONS, SPECIFICALLY THE WARRANTY THEREIN, WHICH COVERS THESE PRODUCTS.

**LIFE SUPPORT POLICY**

FAIRCHILD'S PRODUCTS ARE NOT AUTHORIZED FOR USE AS CRITICAL COMPONENTS IN LIFE SUPPORT DEVICES OR SYSTEMS WITHOUT THE EXPRESS WRITTEN APPROVAL OF FAIRCHILD SEMICONDUCTOR CORPORATION.

As used here in:

- Life support devices or systems are devices or systems which, (a) are intended for surgical implant into the body or (b) support or sustain life, and (c) whose failure to perform when properly used in accordance with instructions for use provided in the labeling, can be reasonably expected to result in a significant injury of the user.
- A critical component in any component of a life support, device, or system whose failure to perform can be reasonably expected to cause the failure of the life support device or system, or to affect its safety or effectiveness.

**ANTI-COUNTERFEITING POLICY**

Fairchild Semiconductor Corporation's Anti-Counterfeiting Policy. Fairchild's Anti-Counterfeiting Policy is also stated on our external website, www.Fairchildsemi.com, under Sales Support.

Counterfeiting of semiconductor parts is a growing problem in the industry. All manufactures of semiconductor products are experiencing counterfeiting of their parts. Customers who inadvertently purchase counterfeit parts experience many problems such as loss of brand reputation, substandard performance, failed application, and increased cost of production and manufacturing delays. Fairchild is taking strong measures to protect ourselves and our customers from the proliferation of counterfeit parts. Fairchild strongly encourages customers to purchase Fairchild parts either directly from Fairchild or from Authorized Fairchild Distributors who are listed by country on our web page cited above. Products customers buy either from Fairchild directly or from Authorized Fairchild Distributors are genuine parts, have full traceability, meet Fairchild's quality standards for handling and storage and provide access to Fairchild's full range of up-to-date technical and product information. Fairchild and our Authorized Distributors will stand behind all warranties and will appropriately address and warranty issues that may arise. Fairchild will not provide any warranty coverage or other assistance for parts bought from Unauthorized Sources. Fairchild is committed to combat this global problem and encourage our customers to do their part in stopping this practice by buying direct or from authorized distributors.

**PRODUCT STATUS DEFINITIONS**

**Definition of Terms**

Datasheet Identification	Product Status	Definition
Advance Information	Formative / In Design	Datasheet contains the design specifications for product development. Specifications may change in any manner without notice.
Preliminary	First Production	Datasheet contains preliminary data; supplementary data will be published at a later date. Fairchild Semiconductor reserves the right to make changes at any time without notice to improve design.
No Identification Needed	Full Production	Datasheet contains final specifications. Fairchild Semiconductor reserves the right to make changes at any time without notice to improve the design.
Obsolete	Not In Production	Datasheet contains specifications on a product that is discontinued by Fairchild Semiconductor. The datasheet is for reference information only.

Rev. I68

# Mouser Electronics

Authorized Distributor

Click to View Pricing, Inventory, Delivery & Lifecycle Information:

[Fairchild Semiconductor:](#)

[FDMB2308PZ](#)