



# FDD86102LZ

## N-Channel Shielded Gate PowerTrench<sup>®</sup> MOSFET

100 V, 35 A, 22.5 mΩ

### Features

- Shielded Gate MOSFET Technology
- Max  $r_{DS(on)}$  = 22.5 mΩ at  $V_{GS} = 10\text{ V}$ ,  $I_D = 8\text{ A}$
- Max  $r_{DS(on)}$  = 31 mΩ at  $V_{GS} = 4.5\text{ V}$ ,  $I_D = 7\text{ A}$
- HBM ESD protection level > 6 kV typical (Note 4)
- Very low  $Q_g$  and  $Q_{gd}$  compared to competing trench technologies
- Fast switching speed
- 100% UIL tested
- RoHS Compliant

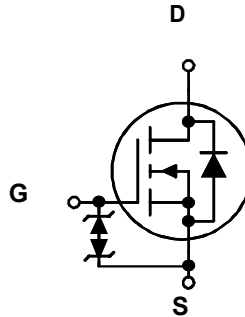
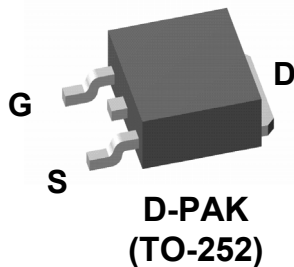


### General Description

This N-Channel MOSFET is produced using Fairchild Semiconductor's advanced PowerTrench<sup>®</sup> process that incorporates Shielded Gate technology. This process has been optimized for the on-state resistance and switching loss. G-S zener has been added to enhance ESD voltage level.

### Applications

- DC - DC Conversion
- Inverter
- Synchronous Rectifier



### MOSFET Maximum Ratings $T_C = 25\text{ °C}$ unless otherwise noted

Symbol	Parameter	Rated	Units
$V_{DS}$	Drain to Source Voltage	100	V
$V_{GS}$	Gate to Source Voltage	±20	V
$I_D$	Drain Current -Continuous $T_C = 25\text{ °C}$	35	A
	-Continuous $T_A = 25\text{ °C}$ (Note 1a)	8	
	-Pulsed	40	
$E_{AS}$	Single Pulse Avalanche Energy (Note 3)	84	mJ
$P_D$	Power Dissipation $T_C = 25\text{ °C}$	54	W
	Power Dissipation $T_A = 25\text{ °C}$ (Note 1a)	3.1	
$T_J, T_{STG}$	Operating and Storage Junction Temperature Range	-55 to +150	°C

### Thermal Characteristics

$R_{\theta JC}$	Thermal Resistance, Junction to Case	2.3	°C/W
$R_{\theta JA}$	Thermal Resistance, Junction to Ambient (Note 1a)	40	

### Package Marking and Ordering Information

Device Marking	Device	Package	Reel Size	Tape Width	Quantity
FDD86102LZ	FDD86102LZ	D-PAK(TO-252)	13 "	16 mm	2500 units

FDD86102LZ N-Channel Shielded Gate PowerTrench<sup>®</sup> MOSFET

## Electrical Characteristics $T_J = 25\text{ }^\circ\text{C}$ unless otherwise noted

Symbol	Parameter	Test Conditions	Min	Typ	Max	Units
$BV_{DSS}$	Drain to Source Breakdown Voltage	$I_D = 250\text{ }\mu\text{A}$ , $V_{GS} = 0\text{ V}$	100			V
$\frac{\Delta BV_{DSS}}{\Delta T_J}$	Breakdown Voltage Temperature Coefficient	$I_D = 250\text{ }\mu\text{A}$ , referenced to $25\text{ }^\circ\text{C}$		69		mV/ $^\circ\text{C}$
$I_{DSS}$	Zero Gate Voltage Drain Current	$V_{DS} = 80\text{ V}$ , $V_{GS} = 0\text{ V}$			1	$\mu\text{A}$
$I_{GSS}$	Gate to Source Leakage Current	$V_{GS} = \pm 20\text{ V}$ , $V_{DS} = 0\text{ V}$			$\pm 10$	$\mu\text{A}$

### On Characteristics (Note 2)

$V_{GS(th)}$	Gate to Source Threshold Voltage	$V_{GS} = V_{DS}$ , $I_D = 250\text{ }\mu\text{A}$	1.0	1.5	3.0	V
$\frac{\Delta V_{GS(th)}}{\Delta T_J}$	Gate to Source Threshold Voltage Temperature Coefficient	$I_D = 250\text{ }\mu\text{A}$ , referenced to $25\text{ }^\circ\text{C}$		-6		mV/ $^\circ\text{C}$
$r_{DS(on)}$	Static Drain to Source On Resistance	$V_{GS} = 10\text{ V}$ , $I_D = 8\text{ A}$		17.8	22.5	m $\Omega$
		$V_{GS} = 4.5\text{ V}$ , $I_D = 7\text{ A}$		23.2	31	
		$V_{GS} = 10\text{ V}$ , $I_D = 8\text{ A}$ , $T_J = 125\text{ }^\circ\text{C}$		31.1	40	
$g_{FS}$	Forward Transconductance	$V_{DS} = 5\text{ V}$ , $I_D = 8\text{ A}$		31		S

### Dynamic Characteristics

$C_{iss}$	Input Capacitance	$V_{DS} = 50\text{ V}$ , $V_{GS} = 0\text{ V}$ , $f = 1\text{ MHz}$		1157	1540	pF
$C_{oss}$	Output Capacitance			181	245	pF
$C_{rss}$	Reverse Transfer Capacitance			7.7	15	pF
$R_g$	Gate Resistance			0.6		$\Omega$

### Switching Characteristics

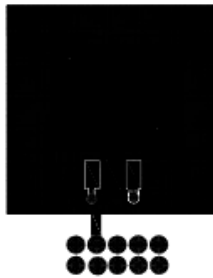
$t_{d(on)}$	Turn-On Delay Time	$V_{DD} = 50\text{ V}$ , $I_D = 8\text{ A}$ , $V_{GS} = 10\text{ V}$ , $R_{GEN} = 6\text{ }\Omega$		6.6	14	ns
$t_r$	Rise Time			2.3	10	ns
$t_{d(off)}$	Turn-Off Delay Time			20	32	ns
$t_f$	Fall Time			2.3	10	ns
$Q_g$	Total Gate Charge		$V_{GS} = 0\text{ V to } 10\text{ V}$		18	26
$Q_g$	Total Gate Charge	$V_{GS} = 0\text{ V to } 4.5\text{ V}$	$V_{DD} = 50\text{ V}$ , $I_D = 8\text{ A}$	8.7	13	nC
$Q_{gs}$	Gate to Source Gate Charge			2.7		nC
$Q_{gd}$	Gate to Drain "Miller" Charge			2.4		nC

### Drain-Source Diode Characteristics

$V_{SD}$	Source to Drain Diode Forward Voltage	$V_{GS} = 0\text{ V}$ , $I_S = 8\text{ A}$ (Note 2)		0.82	1.3	V
		$V_{GS} = 0\text{ V}$ , $I_S = 2.6\text{ A}$ (Note 2)		0.75	1.2	
$t_{rr}$	Reverse Recovery Time	$I_F = 8\text{ A}$ , $di/dt = 100\text{ A}/\mu\text{s}$		43	70	ns
$Q_{rr}$	Reverse Recovery Charge			43	70	nC

#### Notes:

- $R_{\theta JA}$  is the sum of the junction-to-case and case-to-ambient thermal resistance where the case thermal reference is defined as the solder mounting surface of the drain pins.  $R_{\theta JC}$  is guaranteed by design while  $R_{\theta JA}$  is determined by the user's board design.



a.  $40\text{ }^\circ\text{C/W}$  when mounted on a  $1\text{ in}^2$  pad of 2 oz copper.



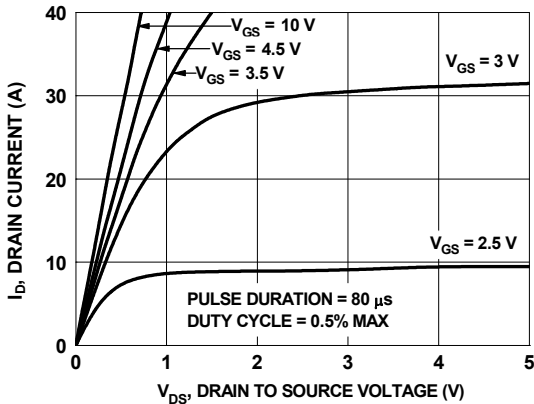
b.  $96\text{ }^\circ\text{C/W}$  when mounted on a minimum pad of 2 oz copper.

2. Pulse Test: Pulse Width <  $300\text{ }\mu\text{s}$ , Duty cycle < 2.0%.

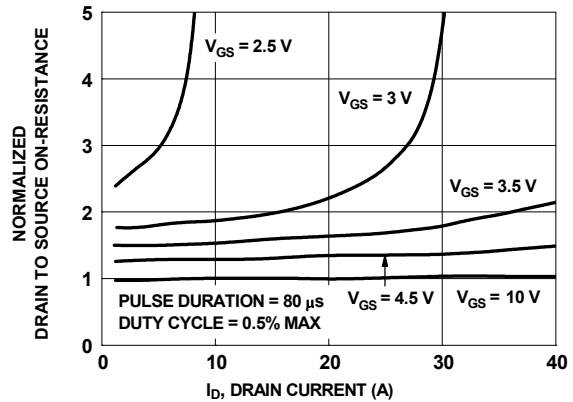
3. Starting  $T_J = 25\text{ }^\circ\text{C}$ ,  $L = 1\text{ mH}$ ,  $I_{AS} = 13\text{ A}$ ,  $V_{DD} = 90\text{ V}$ ,  $V_{GS} = 10\text{ V}$ .

4. The diode connected between the gate and source serves only as protection against ESD. No gate overvoltage rating is implied.

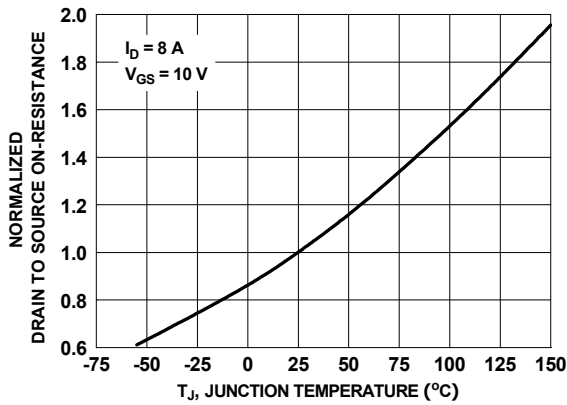
**Typical Characteristics**  $T_J = 25\text{ }^\circ\text{C}$  unless otherwise noted



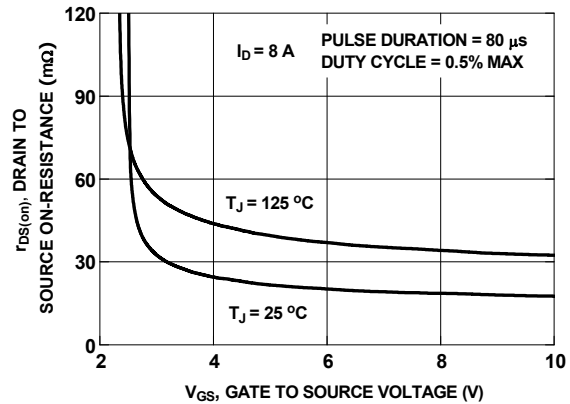
**Figure 1. On-Region Characteristics**



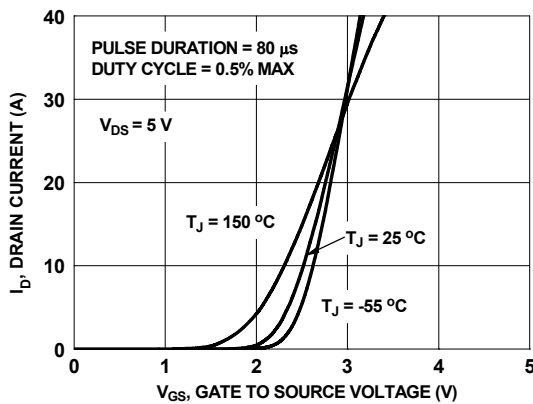
**Figure 2. Normalized On-Resistance vs Drain Current and Gate Voltage**



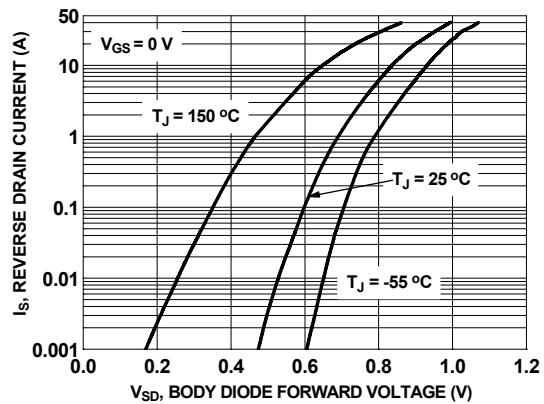
**Figure 3. Normalized On-Resistance vs Junction Temperature**



**Figure 4. On-Resistance vs Gate to Source Voltage**

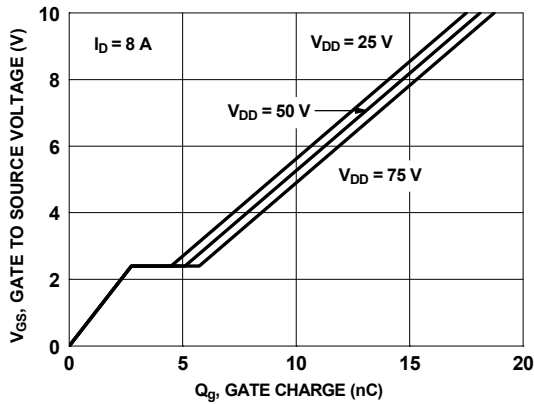


**Figure 5. Transfer Characteristics**

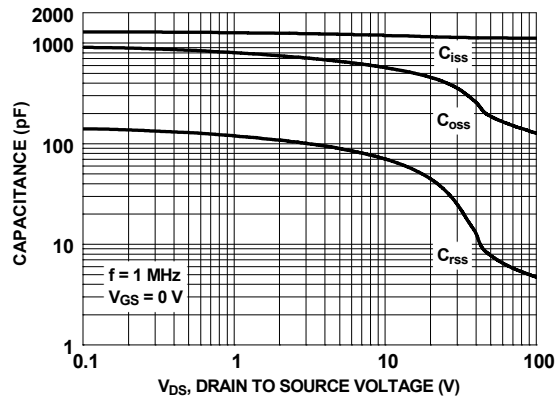


**Figure 6. Source to Drain Diode Forward Voltage vs Source Current**

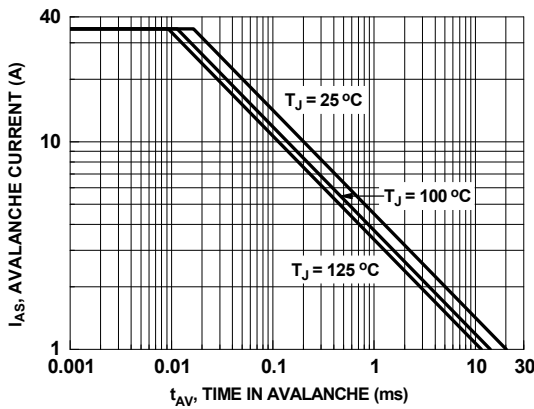
**Typical Characteristics**  $T_J = 25\text{ }^\circ\text{C}$  unless otherwise noted



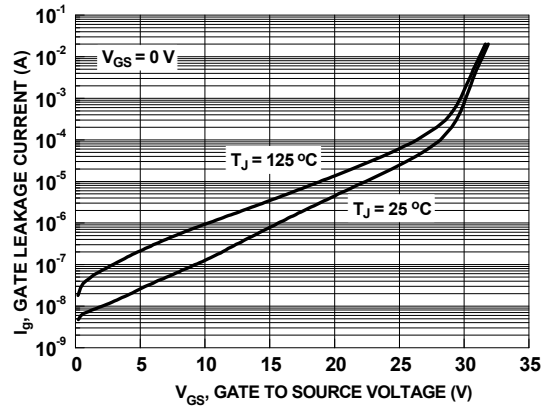
**Figure 7. Gate Charge Characteristics**



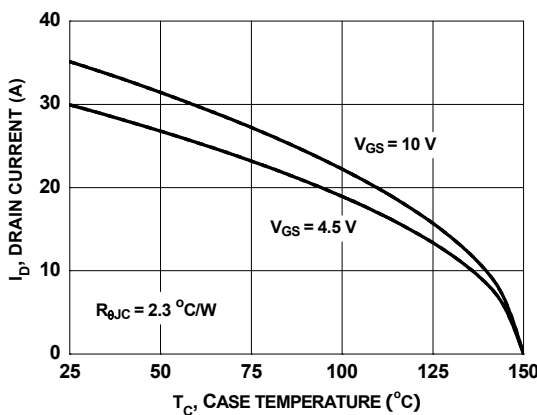
**Figure 8. Capacitance vs Drain to Source Voltage**



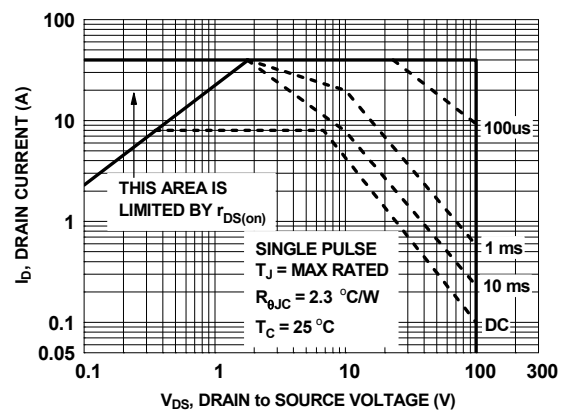
**Figure 9. Unclamped Inductive Switching Capability**



**Figure 10. Gate Leakage Current vs Gate to Source Voltage**

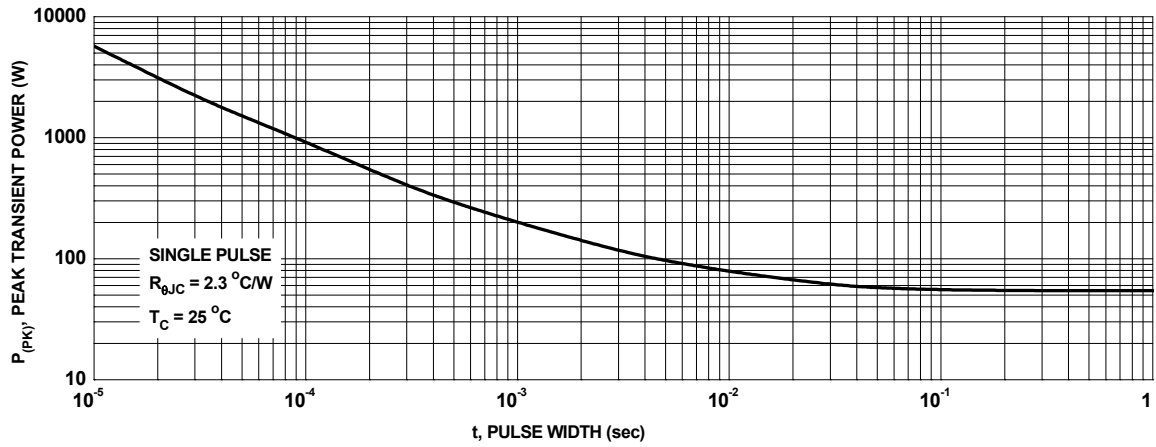


**Figure 11. Maximum Continuous Drain Current vs Case Temperature**

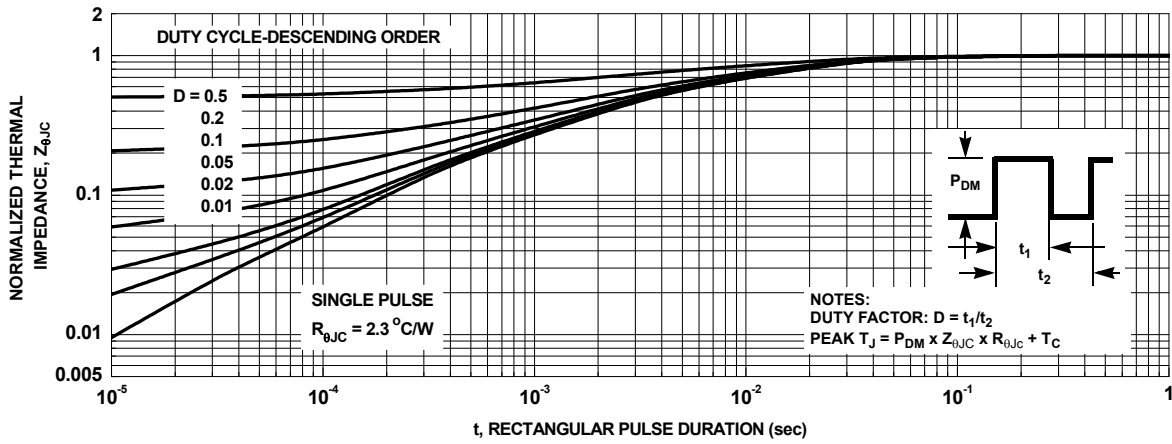


**Figure 12. Forward Bias Safe Operating Area**

**Typical Characteristics**  $T_J = 25^\circ\text{C}$  unless otherwise noted



**Figure 13. Single Pulse Maximum Power Dissipation**

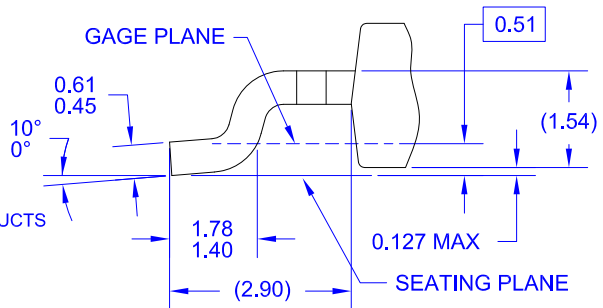


**Figure 14. Junction-to-Case Transient Thermal Response Curve**



NOTES: UNLESS OTHERWISE SPECIFIED

- A) THIS PACKAGE CONFORMS TO JEDEC, TO-252, ISSUE C, VARIATION AA.
- B) ALL DIMENSIONS ARE IN MILLIMETERS.
- C) DIMENSIONING AND TOLERANCING PER ASME Y14.5M-2009.
- D) SUPPLIER DEPENDENT MOLD LOCKING HOLES OR CHAMFERED CORNERS OR EDGE PROTRUSION.
- E) TRIMMED METAL CENTER LEAD IS PRESENT ON FOR NON-DIODE PRODUCTS
- F) DIMENSIONS ARE EXCLUSIVE OF BURS, MOLD FLASH AND TIE BAR EXTRUSIONS.
- G) LAND PATTERN RECOMMENDATION IS BASED ON IPC7351A STD TO228P991X239-3N.
- H) DRAWING NUMBER AND REVISION: MKT-TO252A03REV11





**TRADEMARKS**

The following includes registered and unregistered trademarks and service marks, owned by Fairchild Semiconductor and/or its global subsidiaries, and is not intended to be an exhaustive list of all such trademarks.

- |                          |  |                                       |                  |
|--------------------------|--|---------------------------------------|------------------|
| AccuPower™               | F-PFS™   | OPTOPLANAR®                           | SYSTEM GENERAL®  |
| AttitudeEngine™          | FRFET®   | Power Supply WebDesigner™             | TinyBoost®       |
| Awinda®                  | Global Power Resource <sup>SM</sup>            | PowerTrench®                          | TinyBuck®        |
| AX-CAP®*                 | GreenBridge™                                   | PowerXS™                              | TinyCalc™        |
| BitSiC™                  | Green FPS™                                     | Programmable Active Droop™            | TinyLogic®       |
| Build it Now™            | Green FPS™ e-Series™                           | QFET®                                 | TINYOPTO™        |
| CorePLUS™                | Gmax™  | QS™                                   | TinyPower™       |
| CorePOWER™               | GTO™   | Quiet Series™                         | TinyPWM™         |
| CROSSVOL™                | IntelliMAX™                                    | RapidConfigure™                       | TinyWire™        |
| CTL™                     | ISOPLANAR™                                     | Saving our world, 1mW/W/kW at a time™ | TranSiC™         |
| Current Transfer Logic™  | Making Small Speakers Sound Louder and Better™ | SignalWise™                           | TriFault Detect™ |
| DEUXPEED®                | MegaBuck™                                      | SmartMax™                             | TRUECURRENT®*    |
| Dual Cool™               | MICROCOUPLER™                                  | SMART START™                          | μSerDes™         |
| EcoSPARK®                | MicroFET™                                      | Solutions for Your Success™           | UHC®             |
| EfficientMax™            | MicroPak™                                      | SPM®                                  | Ultra FRFET™     |
| ESBC™                    | MicroPak2™                                     | STEALTH™                              | UniFET™          |
| F <sup>®</sup>           | MillerDrive™                                   | SuperFET®                             | Vcx™             |
| Fairchild®               | MotionMax™                                     | SuperSOT™-3                           | VisualMax™       |
| Fairchild Semiconductor® | MotionGrid®                                    | SuperSOT™-6                           | VoltagePlus™     |
| FACT Quiet Series™       | MTi®   | SuperSOT™-8                           | XST™             |
| FACT®                    | MTx®   | SupreMOS®                             | Xsens™           |
| FastvCore™               | MVN®   | SyncFET™                              | 仙童®              |
| FETBench™                | mWSaver®                                       | Sync-Lock™                            |                  |
| FPS™                     | OptoHiT™                                       |                                       |                  |
|                          | OPTOLOGIC®                                     |                                       |                  |

\* Trademarks of System General Corporation, used under license by Fairchild Semiconductor.

**DISCLAIMER**

FAIRCHILD SEMICONDUCTOR RESERVES THE RIGHT TO MAKE CHANGES WITHOUT FURTHER NOTICE TO ANY PRODUCTS HEREIN TO IMPROVE RELIABILITY, FUNCTION, OR DESIGN. TO OBTAIN THE LATEST, MOST UP-TO-DATE DATASHEET AND PRODUCT INFORMATION, VISIT OUR WEBSITE AT [HTTP://WWW.FAIRCHILDSEMI.COM](http://www.fairchildsemi.com). FAIRCHILD DOES NOT ASSUME ANY LIABILITY ARISING OUT OF THE APPLICATION OR USE OF ANY PRODUCT OR CIRCUIT DESCRIBED HEREIN; NEITHER DOES IT CONVEY ANY LICENSE UNDER ITS PATENT RIGHTS, NOR THE RIGHTS OF OTHERS. THESE SPECIFICATIONS DO NOT EXPAND THE TERMS OF FAIRCHILD'S WORLDWIDE TERMS AND CONDITIONS, SPECIFICALLY THE WARRANTY THEREIN, WHICH COVERS THESE PRODUCTS.

**AUTHORIZED USE**

Unless otherwise specified in this data sheet, this product is a standard commercial product and is not intended for use in applications that require extraordinary levels of quality and reliability. This product may not be used in the following applications, unless specifically approved in writing by a Fairchild officer: (1) automotive or other transportation, (2) military/aerospace, (3) any safety critical application – including life critical medical equipment – where the failure of the Fairchild product reasonably would be expected to result in personal injury, death or property damage. Customer's use of this product is subject to agreement of this Authorized Use policy. In the event of an unauthorized use of Fairchild's product, Fairchild accepts no liability in the event of product failure. In other respects, this product shall be subject to Fairchild's Worldwide Terms and Conditions of Sale, unless a separate agreement has been signed by both Parties.

**ANTI-COUNTERFEITING POLICY**

Fairchild Semiconductor Corporation's Anti-Counterfeiting Policy. Fairchild's Anti-Counterfeiting Policy is also stated on our external website, [www.fairchildsemi.com](http://www.fairchildsemi.com), under Terms of Use

Counterfeiting of semiconductor parts is a growing problem in the industry. All manufacturers of semiconductor products are experiencing counterfeiting of their parts. Customers who inadvertently purchase counterfeit parts experience many problems such as loss of brand reputation, substandard performance, failed applications, and increased cost of production and manufacturing delays. Fairchild is taking strong measures to protect ourselves and our customers from the proliferation of counterfeit parts. Fairchild strongly encourages customers to purchase Fairchild parts either directly from Fairchild or from Authorized Fairchild Distributors who are listed by country on our web page cited above. Products customers buy either from Fairchild directly or from Authorized Fairchild Distributors are genuine parts, have full traceability, meet Fairchild's quality standards for handling and storage and provide access to Fairchild's full range of up-to-date technical and product information. Fairchild and our Authorized Distributors will stand behind all warranties and will appropriately address any warranty issues that may arise. Fairchild will not provide any warranty coverage or other assistance for parts bought from Unauthorized Sources. Fairchild is committed to combat this global problem and encourage our customers to do their part in stopping this practice by buying direct or from authorized distributors.

**PRODUCT STATUS DEFINITIONS**

**Definition of Terms**

Datasheet Identification	Product Status	Definition
Advance Information	Formative / In Design	Datasheet contains the design specifications for product development. Specifications may change in any manner without notice.
Preliminary	First Production	Datasheet contains preliminary data; supplementary data will be published at a later date. Fairchild Semiconductor reserves the right to make changes at any time without notice to improve design.
No Identification Needed	Full Production	Datasheet contains final specifications. Fairchild Semiconductor reserves the right to make changes at any time without notice to improve the design.
Obsolete	Not In Production	Datasheet contains specifications on a product that is discontinued by Fairchild Semiconductor. The datasheet is for reference information only.

Rev. I77

# Mouser Electronics

Authorized Distributor

Click to View Pricing, Inventory, Delivery & Lifecycle Information:

[Fairchild Semiconductor:](#)

[FDD86102LZ](#)