



December 2015

# FCH165N60E N-Channel SuperFET® II Easy-Drive MOSFET

600 V, 23 A, 165 mΩ

## Features

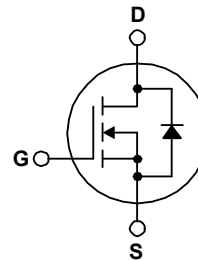
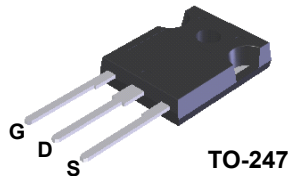
- 650 V @ $T_J = 150^\circ\text{C}$
- Typ.  $R_{DS(on)} = 132\text{ m}\Omega$
- Ultra Low Gate Charge (Typ.  $Q_g = 57\text{ nC}$ )
- Low Effective Output Capacitance (Typ.  $C_{oss(eff)} = 204\text{ pF}$ )
- 100% Avalanche Tested
- RoHS Compliant

## Applications

- Telecom / Server Power Supplies
- Industrial Power Supplies

## Description

SuperFET® II MOSFET is Fairchild Semiconductor's brand-new high voltage super-junction (SJ) MOSFET family that is utilizing charge balance technology for outstanding low on-resistance and lower gate charge performance. This technology is tailored to minimize conduction loss, provide superior switching performance, dv/dt rate and higher avalanche energy. Consequently, SuperFET II MOSFET easy-drive series offers slightly slower rise and fall times compared to the SuperFET II MOSFET series. Noted by the "E" part number suffix, this family helps manage EMI issues and allows for easier design implementation. For faster switching in applications where switching losses must be at an absolute minimum, please consider the SuperFET II MOSFET series.



## Absolute Maximum Ratings $T_C = 25^\circ\text{C}$ unless otherwise noted.

Symbol	Parameter	FCH165N60E	Unit
$V_{DSS}$	Drain to Source Voltage	600	V
$V_{GSS}$	Gate to Source Voltage	- DC	$\pm 20$
		- AC ( $f > 1\text{ Hz}$ )	$\pm 30$
$I_D$	Drain Current	- Continuous ( $T_C = 25^\circ\text{C}$ )	23
		- Continuous ( $T_C = 100^\circ\text{C}$ )	14
$I_{DM}$	Drain Current	- Pulsed (Note 1)	69
$E_{AS}$	Single Pulsed Avalanche Energy (Note 2)	525	mJ
$I_{AR}$	Avalanche Current (Note 1)	5	A
$E_{AR}$	Repetitive Avalanche Energy (Note 1)	2.27	mJ
dv/dt	MOSFET dv/dt	100	V/ns
	Peak Diode Recovery dv/dt (Note 3)	20	
$P_D$	Power Dissipation	( $T_C = 25^\circ\text{C}$ )	227
		- Derate Above $25^\circ\text{C}$	1.82
$T_J, T_{STG}$	Operating and Storage Temperature Range	-55 to +150	$^\circ\text{C}$
$T_L$	Maximum Lead Temperature for Soldering, 1/8" from Case for 5 Seconds	300	$^\circ\text{C}$

## Thermal Characteristics

Symbol	Parameter	FCH165N60E	Unit
$R_{\theta JC}$	Thermal Resistance, Junction to Case, Max.	0.55	$^\circ\text{C}/\text{W}$
$R_{\theta JA}$	Thermal Resistance, Junction to Ambient, Max.	40	

FCH165N60E — N-Channel SuperFET® II Easy-Drive MOSFET

## Package Marking and Ordering Information

Part Number	Top Mark	Package	Packing Method	Reel Size	Tape Width	Quantity
FCH165N60E	FCH165N60E	TO-247	Tube	N/A	N/A	30 units

## Electrical Characteristics $T_C = 25^\circ\text{C}$ unless otherwise noted.

Symbol	Parameter	Test Conditions	Min.	Typ.	Max.	Unit
--------	-----------	-----------------	------	------	------	------

### Off Characteristics

$BV_{DSS}$	Drain to Source Breakdown Voltage	$V_{GS} = 0\text{ V}, I_D = 10\text{ mA}, T_J = 25^\circ\text{C}$	600	-	-	V
		$V_{GS} = 0\text{ V}, I_D = 10\text{ mA}, T_J = 150^\circ\text{C}$	650	-	-	V
$\Delta BV_{DSS} / \Delta T_J$	Breakdown Voltage Temperature Coefficient	$I_D = 10\text{ mA}$ , Referenced to $25^\circ\text{C}$	-	0.7	-	$\text{V}/^\circ\text{C}$
$I_{DSS}$	Zero Gate Voltage Drain Current	$V_{DS} = 600\text{ V}, V_{GS} = 0\text{ V}$	-	-	1	$\mu\text{A}$
		$V_{DS} = 480\text{ V}, V_{GS} = 0\text{ V}, T_C = 125^\circ\text{C}$	-	1.46	-	
$I_{GSS}$	Gate to Body Leakage Current	$V_{GS} = \pm 20\text{ V}, V_{DS} = 0\text{ V}$	-	-	$\pm 100$	nA

### On Characteristics

$V_{GS(th)}$	Gate Threshold Voltage	$V_{GS} = V_{DS}, I_D = 250\text{ }\mu\text{A}$	2.5	-	3.5	V
$R_{DS(on)}$	Static Drain to Source On Resistance	$V_{GS} = 10\text{ V}, I_D = 11.5\text{ A}$	-	132	165	$\text{m}\Omega$
$g_{FS}$	Forward Transconductance	$V_{DS} = 20\text{ V}, I_D = 11.5\text{ A}$	-	20	-	S

### Dynamic Characteristics

$C_{iss}$	Input Capacitance	$V_{DS} = 380\text{ V}, V_{GS} = 0\text{ V}, f = 1\text{ MHz}$	-	1830	2434	pF
$C_{oss}$	Output Capacitance		-	50	67	pF
$C_{riss}$	Reverse Transfer Capacitance		-	8.6	-	pF
$C_{oss(eff.)}$	Effective Output Capacitance	$V_{DS} = 0\text{ V to } 480\text{ V}, V_{GS} = 0\text{ V}$	-	204	-	pF
$Q_{g(tot)}$	Total Gate Charge at 10V	$V_{DS} = 380\text{ V}, I_D = 11.5\text{ A}, V_{GS} = 10\text{ V}$ (Note 4)	-	57	75	nC
$Q_{gs}$	Gate to Source Gate Charge		-	8.3	-	nC
$Q_{gd}$	Gate to Drain "Miller" Charge		-	24	-	nC
ESR	Equivalent Series Resistance	$f = 1\text{ MHz}$	-	6	-	$\Omega$

### Switching Characteristics

$t_{d(on)}$	Turn-On Delay Time	$V_{DD} = 380\text{ V}, I_D = 11.5\text{ A}, V_{GS} = 10\text{ V}, R_g = 4.7\text{ }\Omega$ (Note 4)	-	22	55	ns
$t_r$	Turn-On Rise Time		-	18	46	ns
$t_{d(off)}$	Turn-Off Delay Time		-	100	210	ns
$t_f$	Turn-Off Fall Time		-	18	47	ns

### Drain-Source Diode Characteristics

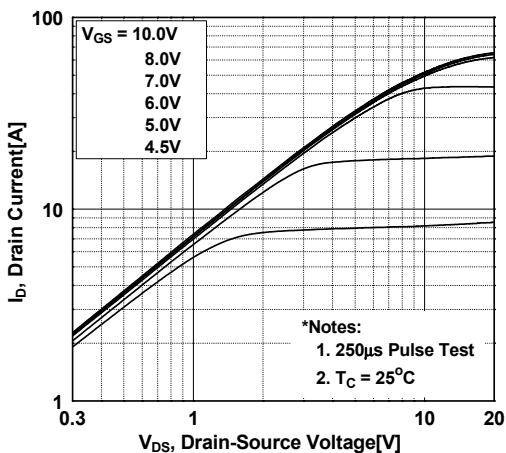
$I_S$	Maximum Continuous Drain to Source Diode Forward Current	-	-	23	A	
$I_{SM}$	Maximum Pulsed Drain to Source Diode Forward Current	-	-	69	A	
$V_{SD}$	Drain to Source Diode Forward Voltage	$V_{GS} = 0\text{ V}, I_{SD} = 11.5\text{ A}$	-	-	1.2	V
$t_{rr}$	Reverse Recovery Time	$V_{GS} = 0\text{ V}, I_{SD} = 11.5\text{ A}, di_F/dt = 100\text{ A}/\mu\text{s}$	-	326	-	ns
$Q_{rr}$	Reverse Recovery Charge		-	5.3	-	$\mu\text{C}$

#### Notes:

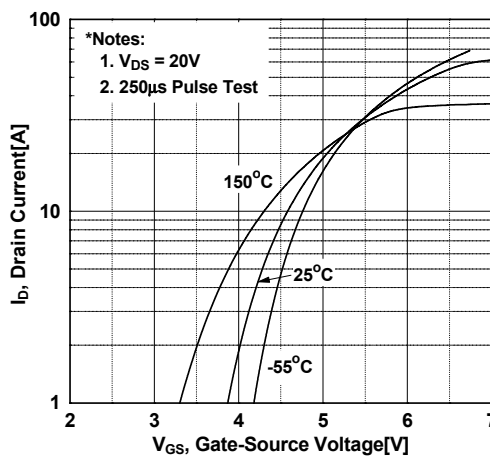
1. Repetitive rating: pulse width limited by maximum junction temperature.
2.  $I_{AS} = 5.0\text{ A}, R_G = 25\text{ }\Omega$ , Starting  $T_J = 25^\circ\text{C}$
3.  $I_{SD} \leq 11.5\text{ A}, di/dt \leq 200\text{ A}/\mu\text{s}, V_{DD} \leq 380\text{ V}$ , Starting  $T_J = 25^\circ\text{C}$
4. Essentially independent of operating temperature.

## Typical Performance Characteristics

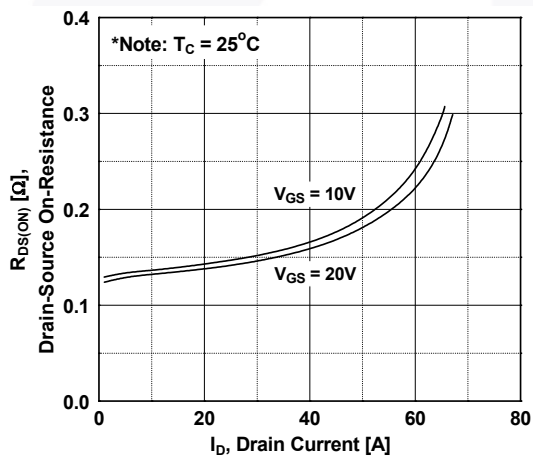
**Figure 1. On-Region Characteristics**



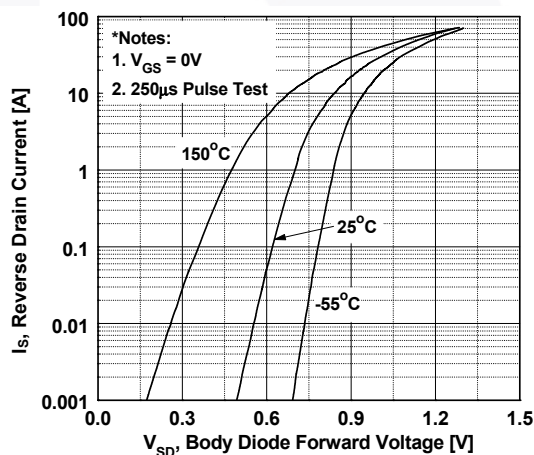
**Figure 2. Transfer Characteristics**



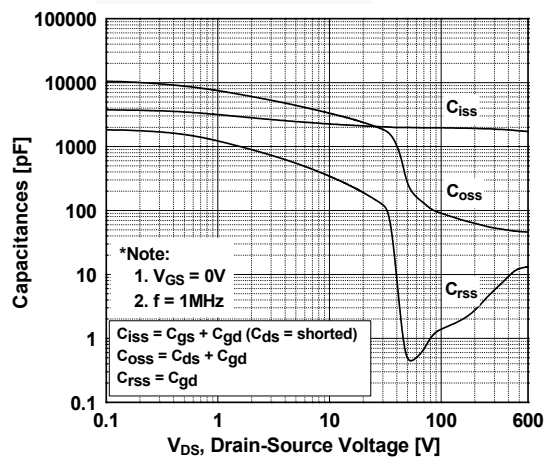
**Figure 3. On-Resistance Variation vs. Drain Current and Gate Voltage**



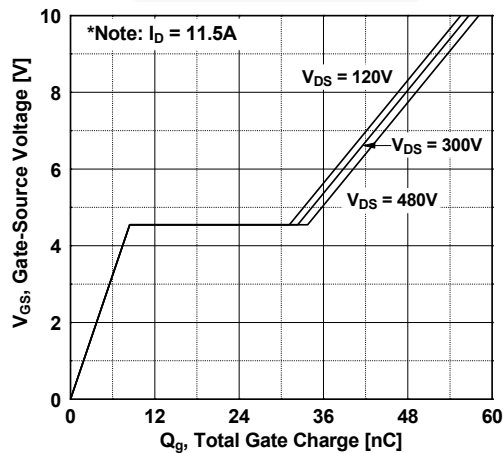
**Figure 4. Body Diode Forward Voltage Variation vs. Source Current and Temperature**



**Figure 5. Capacitance Characteristics**

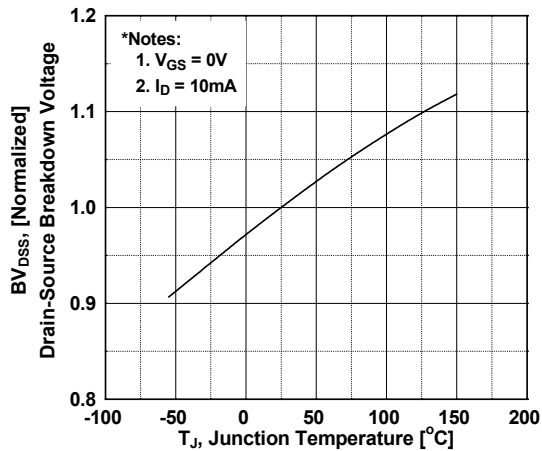


**Figure 6. Gate Charge Characteristics**

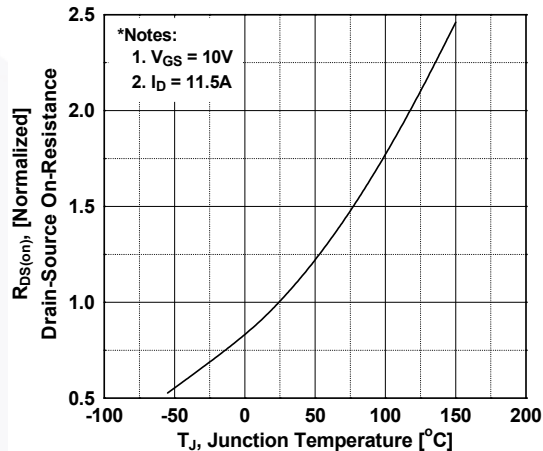


**Typical Performance Characteristics** (Continued)

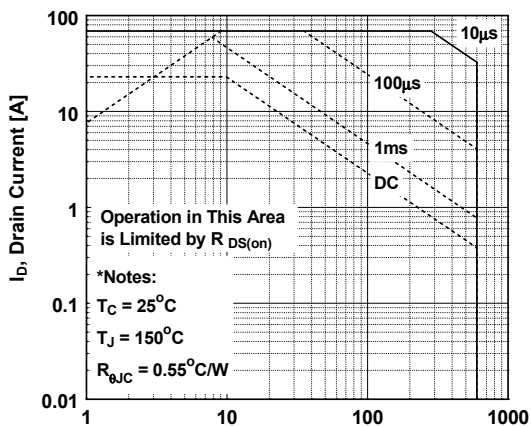
**Figure 7. Breakdown Voltage Variation vs. Temperature**



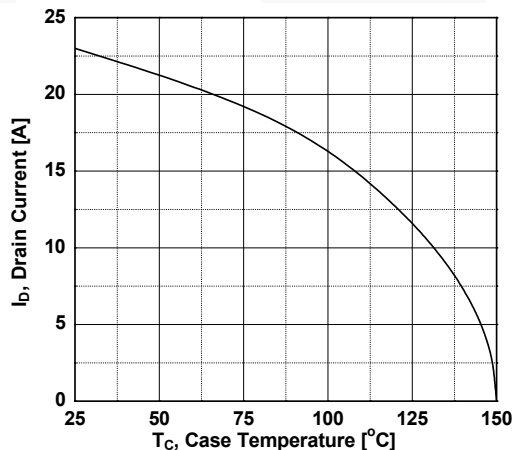
**Figure 8. On-Resistance Variation vs. Temperature**



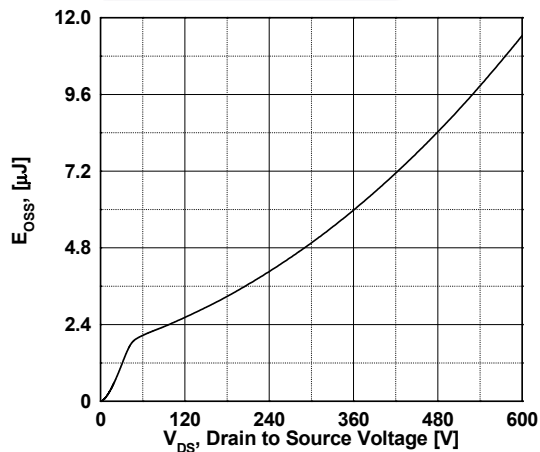
**Figure 9. Maximum Safe Operating Area**



**Figure 10. Maximum Drain Current vs. Case Temperature**

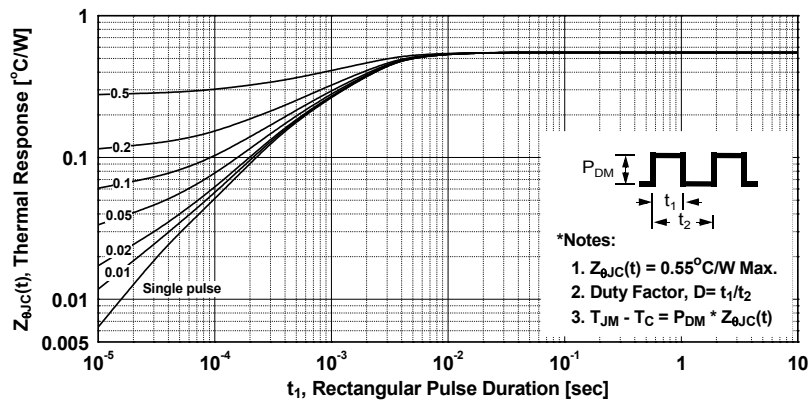


**Figure 11. Eoss vs. Drain to Source Voltage**



Typical Performance Characteristics (Continued)

Figure 12. Transient Thermal Response Curve



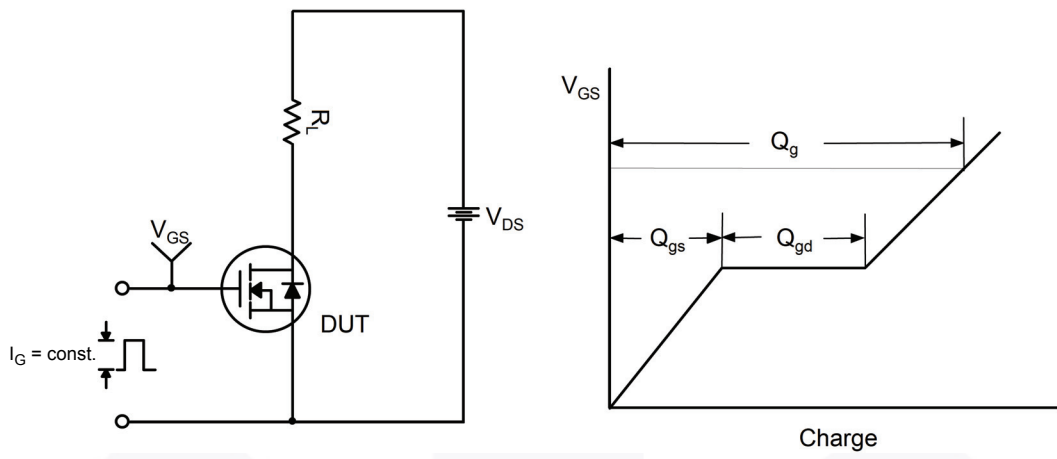


Figure 13. Gate Charge Test Circuit & Waveform

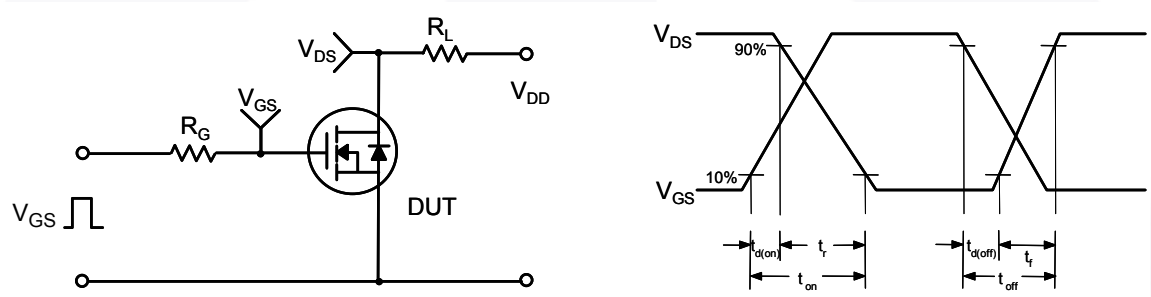


Figure 14. Resistive Switching Test Circuit & Waveforms

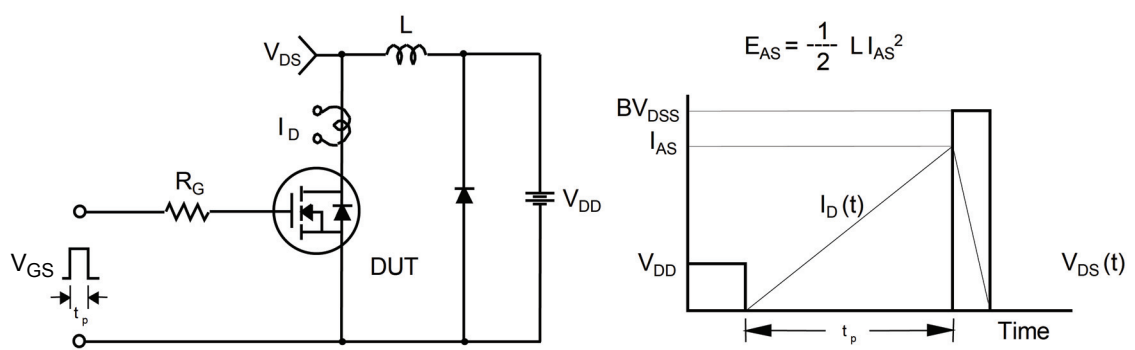


Figure 15. Unclamped Inductive Switching Test Circuit & Waveforms

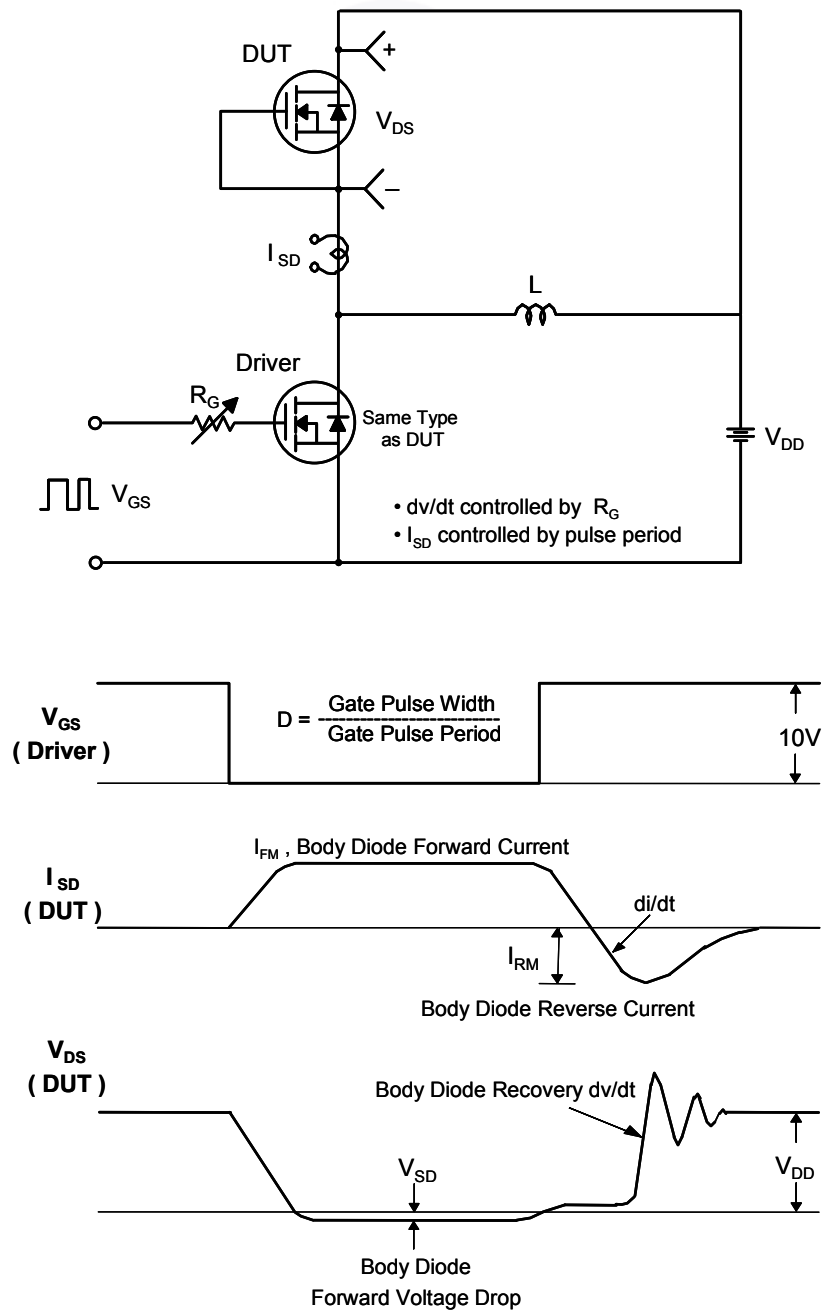


Figure 16. Peak Diode Recovery  $dv/dt$  Test Circuit & Waveforms












**TRADEMARKS**

The following includes registered and unregistered trademarks and service marks, owned by Fairchild Semiconductor and/or its global subsidiaries, and is not intended to be an exhaustive list of all such trademarks.

- |   |   |   |   |
|---|---|---|---|
| AccuPower™  | F-PFS™  | OPTOPLANAR®   |  |
| AttitudeEngine™   | FRFET®  |  | TinyBoost®  |
| Awinda®*  | Global Power ResourceSM                         | Power Supply WebDesigner™   | TinyBuck®   |
| AX-CAP®*  | GreenBridge™                                    | PowerTrench®  | TinyCalc™   |
| BitSiC™   | Green FPS™                                      | PowerXS™  | TinyLogic®  |
| Build it Now™   | Green FPS™ e-Series™                            | Programmable Active Droop™  | TINYOPTO™   |
| CorePLUS™   | Gmax™   | QFET®   | TinyPower™  |
| CorePOWER™  | GTO™  | QS™   | TinyPWM™  |
| CROSSVOLT™  | IntelliMAX™                                     | Quiet Series™   | TinyWire™   |
| CTL™  | ISOPLANAR™                                      | RapidConfigure™   | TranSiC™  |
| Current Transfer Logic™   | Marking Small Speakers Sound Louder and Better™ |  | TriFault Detect™  |
| DEUXPEED®   | MegaBuck™                                       | Saving our world, 1mW/W/kW at a time™   | TRUECURRENT®*   |
| Dual Cool™  | MICROCOUPLER™                                   | SignalWise™   | μSerDes™  |
| EcoSPARK®   | MicroFET™                                       | SmartMax™   |  |
| EfficientMax™   | MicroPak™                                       | SMART START™  | UHC®  |
| ESBC™   | MicroPak2™                                      | Solutions for Your Success™   | Ultra FRFET™  |
|  | MillerDrive™                                    | SPM®  | UniFET™   |
| Fairchild®  | MotionMax™                                      | STEALTH™  | VCX™  |
| Fairchild Semiconductor®  | MotionGrid®                                     | SuperFET®   | VisualMax™  |
| FACT Quiet Series™  | MTI®  | SuperSOT™-3   | VoltagePlus™  |
| FACT®   | MTx®  | SuperSOT™-6   | XS™   |
| FastvCore™  | MVN®  | SuperSOT™-8   | Xsens™  |
| FETBench™   | mWSaver®  | SupreMOS®   | ? ? ®   |
| FPS™  | OptoHiT™  | SyncFET™  |   |
|   | OPTOLOGIC®                                      | Sync-Lock™  |   |

\*Trademarks of System General Corporation, used under license by Fairchild Semiconductor.

**DISCLAIMER**

FAIRCHILD SEMICONDUCTOR RESERVES THE RIGHT TO MAKE CHANGES WITHOUT FURTHER NOTICE TO ANY PRODUCTS HEREIN TO IMPROVE RELIABILITY, FUNCTION, OR DESIGN. TO OBTAIN THE LATEST, MOST UP-TO-DATE DATASHEET AND PRODUCT INFORMATION, VISIT OUR WEBSITE AT <http://www.fairchildsemi.com>. FAIRCHILD DOES NOT ASSUME ANY LIABILITY ARISING OUT OF THE APPLICATION OR USE OF ANY PRODUCT OR CIRCUIT DESCRIBED HEREIN; NEITHER DOES IT CONVEY ANY LICENSE UNDER ITS PATENT RIGHTS, NOR THE RIGHTS OF OTHERS. THESE SPECIFICATIONS DO NOT EXPAND THE TERMS OF FAIRCHILD'S WORLDWIDE TERMS AND CONDITIONS, SPECIFICALLY THE WARRANTY THEREIN, WHICH COVERS THESE PRODUCTS.

**AUTHORIZED USE**

Unless otherwise specified in this data sheet, this product is a standard commercial product and is not intended for use in applications that require extraordinary levels of quality and reliability. This product may not be used in the following applications, unless specifically approved in writing by a Fairchild officer: (1) automotive or other transportation, (2) military/aerospace, (3) any safety critical application – including life critical medical equipment – where the failure of the Fairchild product reasonably would be expected to result in personal injury, death or property damage. Customer's use of this product is subject to agreement of this Authorized Use policy. In the event of an unauthorized use of Fairchild's product, Fairchild accepts no liability in the event of product failure. In other respects, this product shall be subject to Fairchild's Worldwide Terms and Conditions of Sale, unless a separate agreement has been signed by both Parties.

**ANTI-COUNTERFEITING POLICY**

Fairchild Semiconductor Corporation's Anti-Counterfeiting Policy. Fairchild's Anti-Counterfeiting Policy is also stated on our external website, [www.fairchildsemi.com](http://www.fairchildsemi.com), under Terms of Use  
Counterfeiting of semiconductor parts is a growing problem in the industry. All manufacturers of semiconductor products are experiencing counterfeiting of their parts. Customers who inadvertently purchase counterfeit parts experience many problems such as loss of brand reputation, substandard performance, failed applications, and increased cost of production and manufacturing delays. Fairchild is taking strong measures to protect ourselves and our customers from the proliferation of counterfeit parts. Fairchild strongly encourages customers to purchase Fairchild parts either directly from Fairchild or from Authorized Fairchild Distributors who are listed by country on our web page cited above. Products customers buy either from Fairchild directly or from Authorized Fairchild Distributors are genuine parts, have full traceability, meet Fairchild's quality standards for handling and storage and provide access to Fairchild's full range of up-to-date technical and product information. Fairchild and our Authorized Distributors will stand behind all warranties and will appropriately address and warranty issues that may arise. Fairchild will not provide any warranty coverage or other assistance for parts bought from Unauthorized Sources. Fairchild is committed to combat this global problem and encourage our customers to do their part in stopping this practice by buying direct or from authorized distributors.

**PRODUCT STATUS DEFINITIONS**

**Definition of Terms**

Datasheet Identification	Product Status	Definition
Advance Information	Formative / In Design	Datasheet contains the design specifications for product development. Specifications may change in any manner without notice.
Preliminary	First Production	Datasheet contains preliminary data; supplementary data will be published at a later date. Fairchild Semiconductor reserves the right to make changes at any time without notice to improve design.
No Identification Needed	Full Production	Datasheet contains final specifications. Fairchild Semiconductor reserves the right to make changes at any time without notice to improve the design.
Obsolete	Not In Production	Datasheet contains specifications on a product that is discontinued by Fairchild Semiconductor. The datasheet is for reference information only.

# Mouser Electronics

Authorized Distributor

Click to View Pricing, Inventory, Delivery & Lifecycle Information:

[Fairchild Semiconductor:](#)

[FCH165N60E](#)