

Features

- Small, Low Profile Surface Mount Package
- Flat Lead Package Design for Low Profile and High Power Dissipation
- **Totally Lead-Free & Fully RoHS Compliant (Notes 1 & 2)**
- **Halogen and Antimony Free. "Green" Device (Note 3)**
- **Qualified to AEC-Q101 Standards for High Reliability**
- **PPAP Capable (Note 4)**

Mechanical Data

- Case: SOD523
- Case Material: Molded Plastic, "Green" Molding Compound. UL Flammability Classification Rating 94V-0
- Moisture Sensitivity: Level 1 per J-STD-020
- Terminal Connections: Cathode Band
- Terminals: Finish - Matte Tin Annealed over Alloy 42 Leadframe. Solderable per MIL-STD-202, Method 208 (e3)
- Weight: 0.001 grams (Approximate)

SOD523



Top View

Ordering Information (Note 5)

Part Number (Note 6)	Compliance	Case	Packaging
(Type Number)-7*	Standard	SOD523	3000/Tape & Reel
(Type Number)Q-7*	Automotive	SOD523	3000/Tape & Reel
(Type Number)-13*	Standard	SOD523	10000/Tape & Reel
(Type Number)Q-13*	Automotive	SOD523	10000/Tape & Reel

*For (Type Number), please see the Electrical Characteristics Table. Example: 6.2V Zener = BZT52C6V2T-7.

- Notes:
1. No purposely added lead. Fully EU Directive 2002/95/EC (RoHS) & 2011/65/EU (RoHS 2) compliant.
 2. See http://www.diodes.com/quality/lead_free.html for more information about Diodes Incorporated's definitions of Halogen- and Antimony-free, "Green" and Lead-free.
 3. Halogen- and Antimony-free "Green" products are defined as those which contain <900ppm bromine, <900ppm chlorine (<1500ppm total Br + Cl) and <1000ppm antimony compounds.
 4. Automotive products are AEC-Q101 qualified and are PPAP capable. Automotive, AEC-Q101 and standard products are electrically and thermally the same, except where specified. For more information, please refer to http://www.diodes.com/product_compliance_definitions.html.
 5. For packaging details, go to our website at <http://www.diodes.com/products/packages.html>.
 6. Dispensed in every other cavity of the tape.

Marking Information

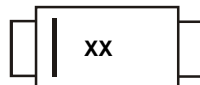

XX = Product Type Marking Code
(See Electrical Characteristics Table)

Maximum Ratings (@T_A = +25°C, unless otherwise specified.)

Single phase, half wave, 60Hz, resistive or inductive load.
For capacitive load, derate current by 20%.

Characteristic	Symbol	Value	Unit
Forward Voltage @ I _F = 10mA	V _F	0.9	V

Thermal Characteristics

Characteristic	Symbol	Value	Unit
Power Dissipation (Note 7)	P _D	300	mW
Thermal Resistance, Junction to Ambient Air (Note 7)	R _{θJA}	417	°C/W
Thermal Resistance, Junction to Case (Note 7)	R _{θJC}	160	°C/W
Operating and Storage Temperature Range	T _J , T _{STG}	-65 to +150	°C

Electrical Characteristics (@T_A = +25°C, unless otherwise specified.)

Type Number	Marking Codes	Zener Voltage Range (Note 8)				Maximum Zener Impedance f = 1kHz			Maximum Reverse Current (Note 8)		Temperature Coefficient @ I _{ZT} mV/°C	
		V _Z @ I _{ZT}			I _{ZT}	Z _{ZT} @ I _{ZT}	Z _{ZK} @ I _{ZK}	I _{ZK}	I _R	@ V _R	Min	Max
		Nom (V)	Min (V)	Max (V)	mA	Ω	mA	μA	V			
BZT52C2V0T	WY	2.0	1.91	2.09	5	100	600	1.0	150	1.0	-3.5	0
BZT52C2V4T	WX	2.4	2.2	2.6	5	100	600	1.0	50	1.0	-3.5	0
BZT52C2V7T	W1	2.7	2.5	2.9	5	100	600	1.0	20	1.0	-3.5	0
BZT52C3V0T	W2	3.0	2.8	3.2	5	95	600	1.0	10	1.0	-3.5	0
BZT52C3V3T	W3	3.3	3.1	3.5	5	95	600	1.0	5.0	1.0	-3.5	0
BZT52C3V6T	W4	3.6	3.4	3.8	5	90	600	1.0	5.0	1.0	-3.5	0
BZT52C3V9T	W5	3.9	3.7	4.1	5	90	600	1.0	3.0	1.0	-3.5	0
BZT52C4V3T	W6	4.3	4.0	4.6	5	90	600	1.0	3.0	1.0	-3.5	0
BZT52C4V7T	W7	4.7	4.4	5.0	5	80	500	1.0	3.0	2.0	-3.5	0.2
BZT52C5V1T	W8	5.1	4.8	5.4	5	60	480	1.0	2.0	2.0	-2.7	1.2
BZT52C5V6T	W9	5.6	5.2	6.0	5	40	400	1.0	1.0	2.0	-2	2.5
BZT52C6V2T	WA	6.2	5.8	6.6	5	10	150	1.0	3.0	4.0	0.4	3.7
BZT52C6V8T	WB	6.8	6.4	7.2	5	15	80	1.0	2.0	4.0	1.2	4.5
BZT52C7V5T	WC	7.5	7.0	7.9	5	15	80	1.0	1.0	5.0	2.5	5.3
BZT52C8V2T	WD	8.2	7.7	8.7	5	15	80	1.0	0.7	5.0	3.2	6.2
BZT52C9V1T	WE	9.1	8.5	9.6	5	15	100	1.0	0.5	6.0	3.8	7.0
BZT52C10T	WF	10	9.4	10.6	5	20	150	1.0	0.2	7.0	4.5	8.0
BZT52C11T	WG	11	10.4	11.6	5	20	150	1.0	0.1	8.0	5.4	9.0
BZT52C12T	WH	12	11.4	12.7	5	25	150	1.0	0.1	8.0	6.0	10.0
BZT52C13T	WI	13	12.4	14.1	5	30	170	1.0	0.1	8.0	7.0	11.0
BZT52C15T	WJ	15	13.8	15.6	5	30	200	1.0	0.1	10.5	9.2	13.0
BZT52C16T	WK	16	15.3	17.1	5	40	200	1.0	0.1	11.2	10.4	14.0
BZT52C18T	WL	18	16.8	19.1	5	45	225	1.0	0.1	12.6	12.4	16.0
BZT52C20T	WM	20	18.8	21.2	5	55	225	1.0	0.1	14.0	14.4	18.0
BZT52C22T	WN	22	20.8	23.3	5	55	250	1.0	0.1	15.4	16.4	20.0
BZT52C24T	WO	24	22.8	25.6	5	70	250	1.0	0.1	16.8	18.4	22.0

Notes: 7. Part mounted on FR-4 PC board, single-sided, 2oz. copper with pad areas 1.92mm².
8. Short duration pulse test used to minimize self-heating effect.

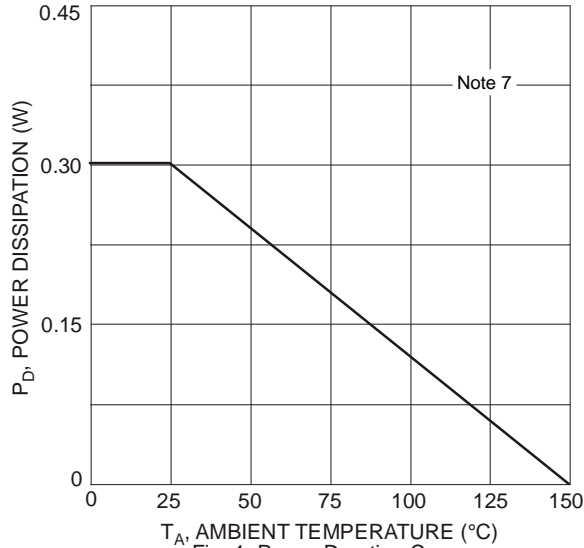

Fig. 1 Power Derating Curve

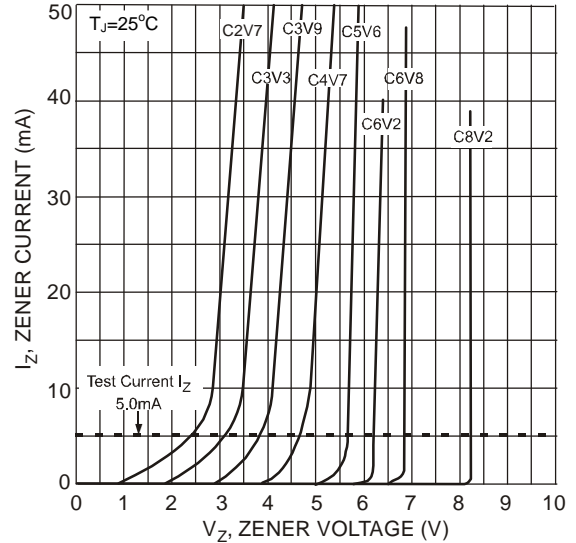

Fig. 2 Typical Zener Breakdown Characteristics

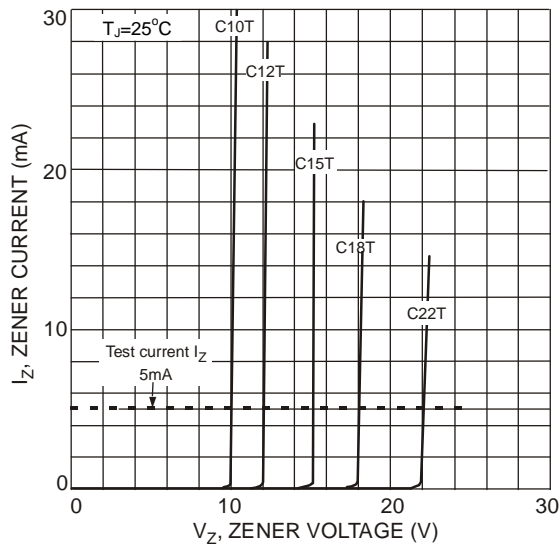

Fig. 3 Typical Zener Breakdown Characteristics

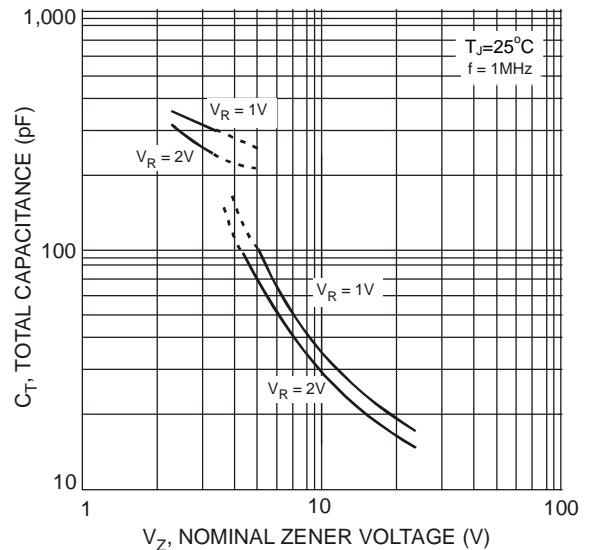

Fig. 4 Typical Total Capacitance vs. Nominal Zener Voltage

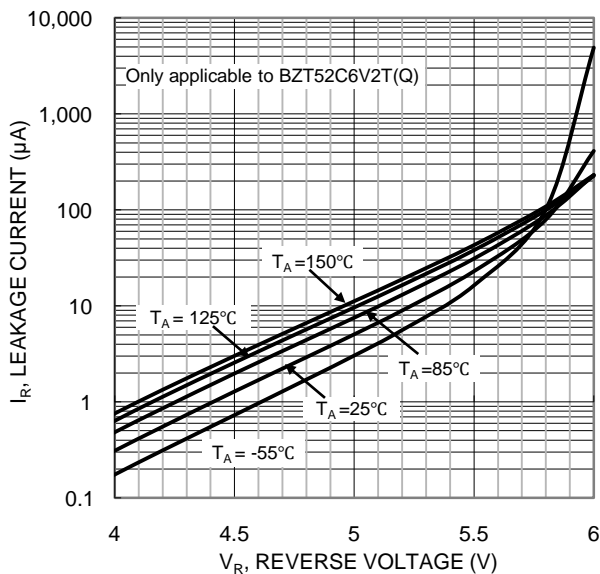
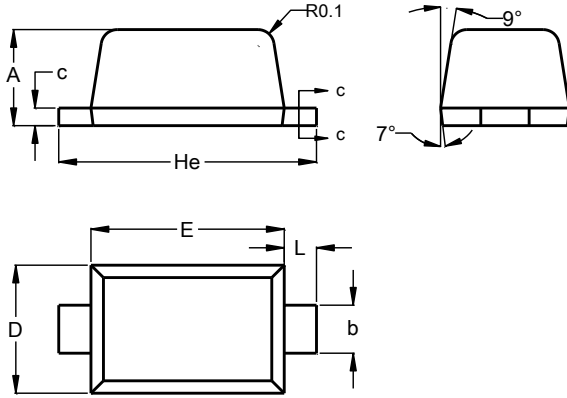

Fig. 5 Typical Reverse Characteristics

Package Outline Dimensions

Please see <http://www.diodes.com/package-outlines.html> for the latest version.

SOD523



SOD523		
Dim	Min	Max
A	0.55	0.65
b	0.26	0.34
c	0.11	0.17
D	0.75	0.85
E	1.15	1.25
He	1.55	1.65
L	0.10	0.30
All Dimensions in mm		

Suggested Pad Layout

Please see <http://www.diodes.com/package-outlines.html> for the latest version.

SOD523

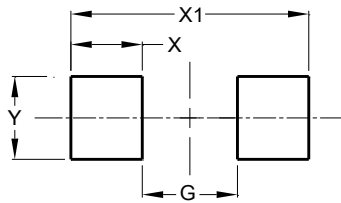

Dimensions	Value (in mm)
G	0.80
X	0.60
X1	2.00
Y	0.70

IMPORTANT NOTICE

DIODES INCORPORATED MAKES NO WARRANTY OF ANY KIND, EXPRESS OR IMPLIED, WITH REGARDS TO THIS DOCUMENT, INCLUDING, BUT NOT LIMITED TO, THE IMPLIED WARRANTIES OF MERCHANTABILITY AND FITNESS FOR A PARTICULAR PURPOSE (AND THEIR EQUIVALENTS UNDER THE LAWS OF ANY JURISDICTION).

Diodes Incorporated and its subsidiaries reserve the right to make modifications, enhancements, improvements, corrections or other changes without further notice to this document and any product described herein. Diodes Incorporated does not assume any liability arising out of the application or use of this document or any product described herein; neither does Diodes Incorporated convey any license under its patent or trademark rights, nor the rights of others. Any Customer or user of this document or products described herein in such applications shall assume all risks of such use and will agree to hold Diodes Incorporated and all the companies whose products are represented on Diodes Incorporated website, harmless against all damages.

Diodes Incorporated does not warrant or accept any liability whatsoever in respect of any products purchased through unauthorized sales channel. Should Customers purchase or use Diodes Incorporated products for any unintended or unauthorized application, Customers shall indemnify and hold Diodes Incorporated and its representatives harmless against all claims, damages, expenses, and attorney fees arising out of, directly or indirectly, any claim of personal injury or death associated with such unintended or unauthorized application.

Products described herein may be covered by one or more United States, international or foreign patents pending. Product names and markings noted herein may also be covered by one or more United States, international or foreign trademarks.

This document is written in English but may be translated into multiple languages for reference. Only the English version of this document is the final and determinative format released by Diodes Incorporated.

LIFE SUPPORT

Diodes Incorporated products are specifically not authorized for use as critical components in life support devices or systems without the express written approval of the Chief Executive Officer of Diodes Incorporated. As used herein:

A. Life support devices or systems are devices or systems which:

1. are intended to implant into the body, or
2. support or sustain life and whose failure to perform when properly used in accordance with instructions for use provided in the labeling can be reasonably expected to result in significant injury to the user.

B. A critical component is any component in a life support device or system whose failure to perform can be reasonably expected to cause the failure of the life support device or to affect its safety or effectiveness.

Customers represent that they have all necessary expertise in the safety and regulatory ramifications of their life support devices or systems, and acknowledge and agree that they are solely responsible for all legal, regulatory and safety-related requirements concerning their products and any use of Diodes Incorporated products in such safety-critical, life support devices or systems, notwithstanding any devices- or systems-related information or support that may be provided by Diodes Incorporated. Further, Customers must fully indemnify Diodes Incorporated and its representatives against any damages arising out of the use of Diodes Incorporated products in such safety-critical, life support devices or systems.

Copyright © 2016, Diodes Incorporated

www.diodes.com

Mouser Electronics

Authorized Distributor

Click to View Pricing, Inventory, Delivery & Lifecycle Information:

[Diodes Inc.:](#)

[BZT52C10T-7](#) [BZT52C11T-7](#) [BZT52C12T-7](#) [BZT52C13T-7](#) [BZT52C15T-7](#) [BZT52C16T-7](#) [BZT52C18T-7](#)
[BZT52C20T-7](#) [BZT52C22T-7](#) [BZT52C24T-7](#) [BZT52C2V0T-7](#) [BZT52C2V4T-7](#) [BZT52C2V7T-7](#) [BZT52C3V0T-7](#)
[BZT52C3V3T-7](#) [BZT52C3V6T-7](#) [BZT52C3V9T-7](#) [BZT52C4V3T-7](#) [BZT52C4V7T-7](#) [BZT52C5V1T-7](#) [BZT52C5V6T-7](#)
[BZT52C6V2T-7](#) [BZT52C6V8T-7](#) [BZT52C7V5T-7](#) [BZT52C8V2T-7](#) [BZT52C9V1T-7](#)