

100V PNP MEDIUM POWER TRANSISTOR IN SOT89
Features

- $BV_{CEO} > -100V$
- $BV_{ECO} > -7V$
- $I_C = -2A$ High Continuous Collector Current
- $I_{CM} = -3A$ Peak Collector Current
- $V_{CE(SAT)} < 130mV @ -1A$
- $R_{CE(SAT)} = 100m\Omega$ for a Low Equivalent On-Resistance
- Complementary NPN Type: ZXTN19100CZ
- **Totally Lead-Free & Fully RoHS Compliant (Notes 1 & 2)**
- **Halogen and Antimony Free. "Green" Device (Note 3)**
- **Qualified to AEC-Q101 Standards for High Reliability**
- **PPAP Capable (Note 4)**

Mechanical Data

- Case: SOT89
- Case Material: Molded Plastic. "Green" Molding Compound
UL Flammability Rating 94V-0
- Moisture Sensitivity: Level 1 per J-STD-020
- Terminals: Finish - Matte Tin Plated Leads, Solderable per
MIL-STD-202, Method 208
- Weight: 0.05 grams (Approximate)

SOT89



Top View

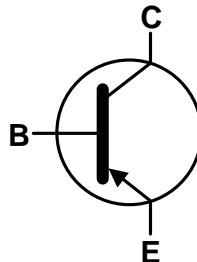

Device Symbol

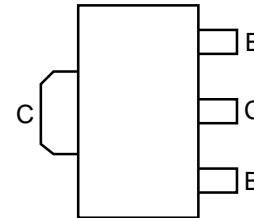
 Top View
Pin Out

Ordering Information (Notes 4 & 5)

Product	Compliance	Marking	Reel Size (inches)	Tape Width (mm)	Quantity per Reel
ZXTP19100CZTA	AEC-Q101	1M3	7	12	1,000
ZXTP19100CZQTA	Automotive	1M3	7	12	1,000

- Notes:
1. No purposely added lead. Fully EU Directive 2002/95/EC (RoHS) & 2011/65/EU (RoHS 2) compliant.
 2. See http://www.diodes.com/quality/lead_free.html for more information about Diodes Incorporated's definitions of Halogen- and Antimony-free, "Green" and Lead-free.
 3. Halogen- and Antimony-free "Green" products are defined as those which contain <900ppm bromine, <900ppm chlorine (<1500ppm total Br + Cl) and <1000ppm antimony compounds.
 4. Automotive products are AEC-Q101 qualified and are PPAP capable. Refer to http://www.diodes.com/product_compliance_definitions.html.
 5. For packaging details, go to our website at <http://www.diodes.com/products/packages.html>.

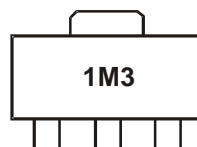
Marking Information

1M3 = Product Type Marking Code

Absolute Maximum Ratings (@T_A = +25°C, unless otherwise specified.)

Characteristic	Symbol	Limit	Unit
Collector-Base Voltage	V _{CB0}	-110	V
Collector-Emitter Voltage (Forward Blocking)	V _{CEx}	-110	V
Collector-Emitter Voltage	V _{CE0}	-100	V
Emitter-Collector Voltage (Reverse Blocking)	V _{EC0}	-7	V
Emitter-Base Voltage	V _{EBO}	-7	V
Continuous Collector Current	I _C	-2	A
Peak Pulse Current	I _{CM}	-3	A
Base Current	I _B	-1	A

Thermal Characteristics (@T_A = +25°C, unless otherwise specified.)

Characteristic	Symbol	Value	Unit
Power Dissipation Linear Derating Factor	P _D	1.1	W mW/°C
		8.8	
		1.8	
		14.4	
		2.4	
Thermal Resistance, Junction to Ambient Air	R _{θJA}	19.2	°C/W
		4.46	
		35.7	
		117	
Thermal Resistance, Junction to Ambient Air	R _{θJA}	68	°C/W
		51	
		28	
		4.7	
Thermal Resistance, Junction to Lead	R _{θJL}	4.7	°C
Operating and Storage Temperature Range	T _J , T _{STG}	-55 to +150	°C

ESD Ratings (Note 11)

Characteristic	Symbol	Value	Unit	JEDEC Class
Electrostatic Discharge - Human Body Model	ESD HBM	4,000	V	3A
Electrostatic Discharge - Machine Model	ESD MM	400	V	C

- Notes:
6. For a device mounted with the exposed collector pad on 15mm x 15mm 1oz copper that is on a single-sided 0.6mm FR-4 PCB; device is measured under still air conditions whilst operating in a steady-state.
 7. Same as Note 6, except the device is mounted on 25mm x 25mm 1oz copper.
 8. Same as Note 6, except the device is mounted on 50mm x 50mm 2oz copper.
 9. Same as Note 8, except the device is measured at t<5 seconds.
 10. Thermal resistance from junction to solder-point (on the exposed collector pad).
 11. Refer to JEDEC specification JESD22-A114 and JESD22-A115.

Thermal Characteristics and Derating Information

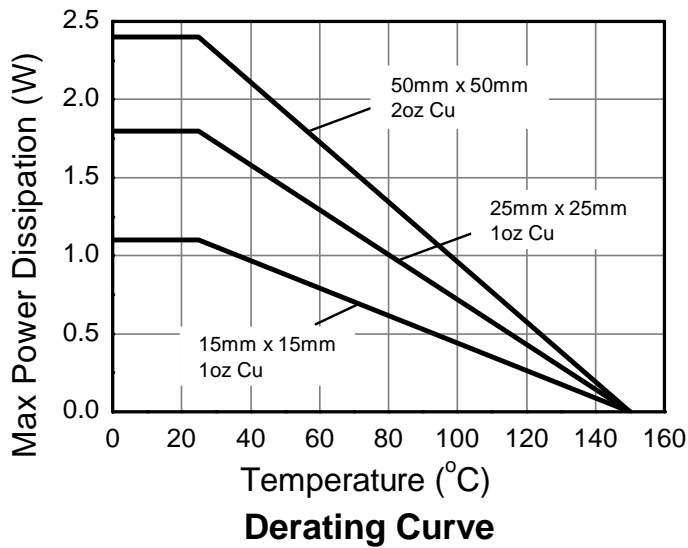
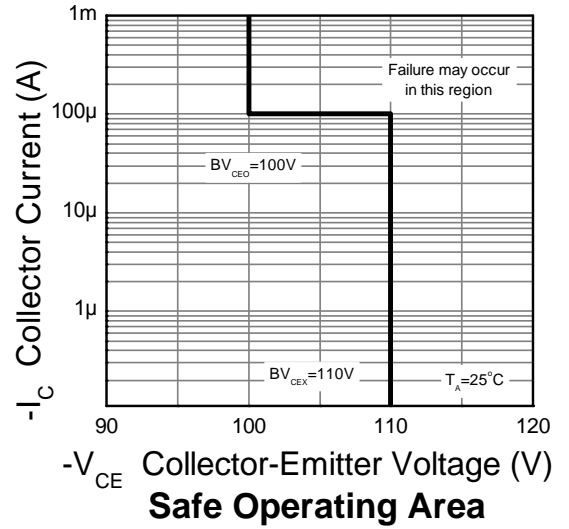
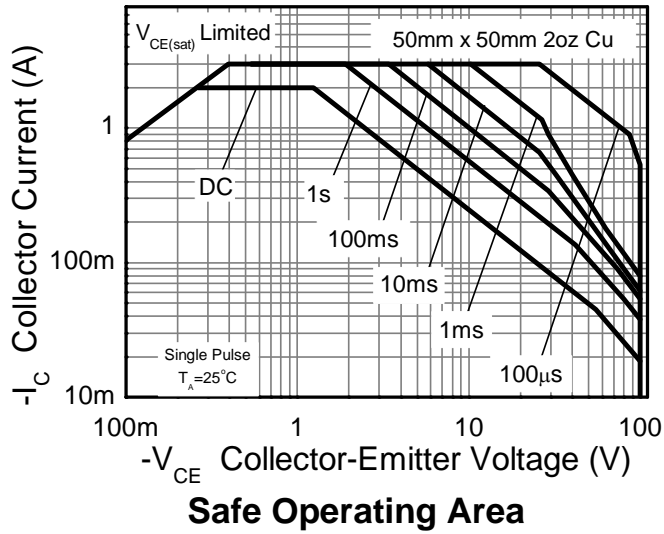

Thermal Characteristics and Derating Information (Cont.)

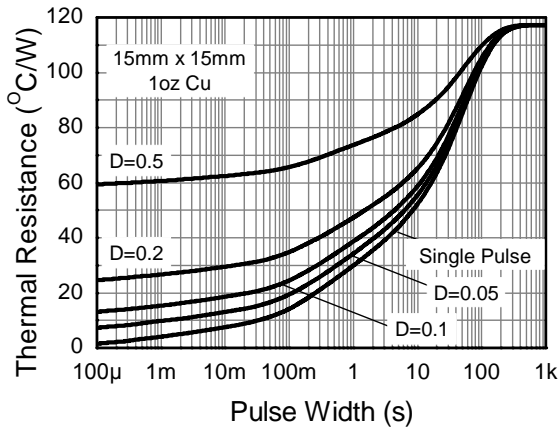

Transient Thermal Impedance

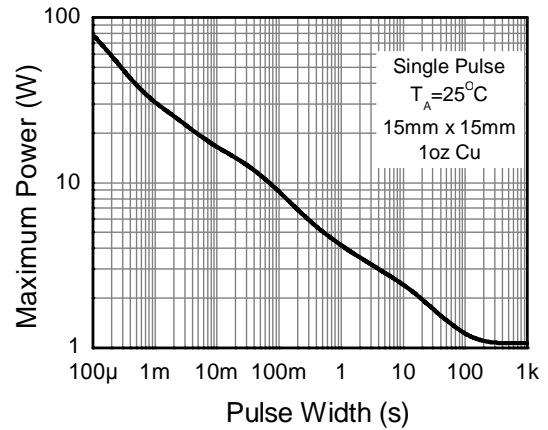

Pulse Power Dissipation

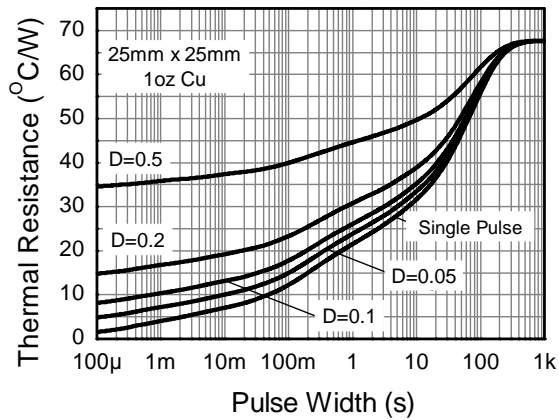

Transient Thermal Impedance

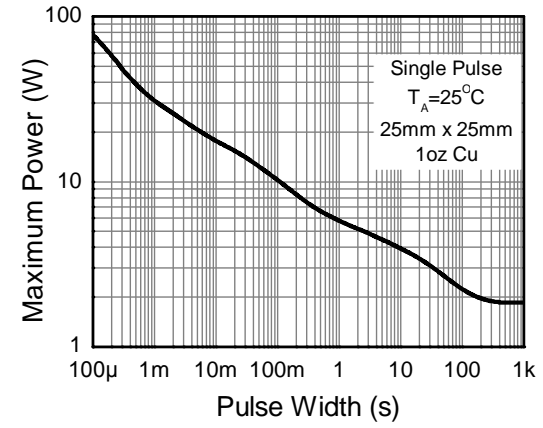

Pulse Power Dissipation

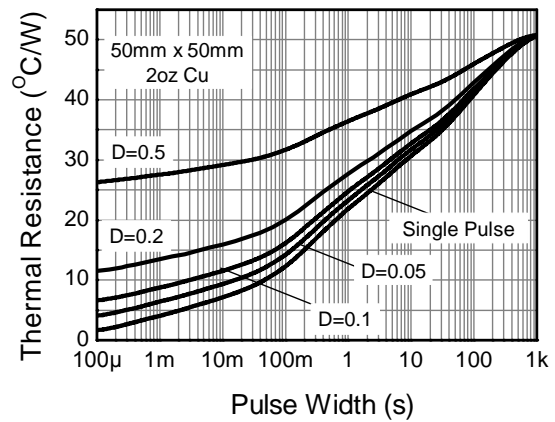

Transient Thermal Impedance

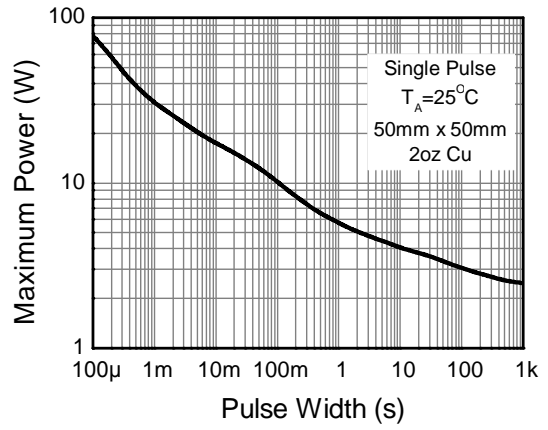

Pulse Power Dissipation

Electrical Characteristics (@ $T_A = +25^\circ\text{C}$, unless otherwise specified.)

Characteristic	Symbol	Min	Typ	Max	Unit	Test Condition
Collector-Base Breakdown Voltage	BV_{CBO}	-110	-135	—	V	$I_C = -100\mu\text{A}$
Collector-Emitter Breakdown Voltage	BV_{CEX}	-110	-135	—	V	$I_E = -100\mu\text{A}$, $R_{BC} < 1\text{k}\Omega$ or $0.25\text{V} > V_{BC} > -0.25\text{V}$
Collector-Emitter Breakdown Voltage (Note 12)	BV_{CEO}	-100	-135	—	V	$I_C = -10\text{mA}$
Emitter-Collector Breakdown Voltage (Reverse Blocking)	BV_{ECX}	-7	-8.3	—	V	$I_E = -100\mu\text{A}$, $R_{BC} < 1\text{k}\Omega$ or $0.25\text{V} > V_{BC} > -0.25\text{V}$
Emitter-Collector Breakdown Voltage (Reverse Blocking)	BV_{ECO}	-7	-8.7	—	V	$I_E = -100\mu\text{A}$
Emitter-Base Breakdown Voltage	BV_{EBO}	-7	-8.3	—	V	$I_E = -100\mu\text{A}$
Collector-Base Cutoff Current	I_{CBO}	—	<1	-50 -0.5	nA μA	$V_{CB} = -110\text{V}$ $V_{CB} = -110\text{V}$, $T_A = +100^\circ\text{C}$
Emitter Cutoff Current	I_{EBO}	—	<1	-50	nA	$V_{EB} = -5.6\text{V}$
DC Current Transfer Static Ratio (Note 12)	h_{FE}	200 70 20	300 130 25	500 — —	—	$I_C = -100\text{mA}$, $V_{CE} = -2\text{V}$ $I_C = -1\text{A}$, $V_{CE} = -2\text{V}$ $I_C = -2\text{A}$, $V_{CE} = -2\text{V}$
Collector-Emitter Saturation Voltage (Note 12)	$V_{CE(SAT)}$	—	-100 -100 -180 -220	-130 -125 -230 -295	mV	$I_C = -500\text{mA}$, $I_B = -20\text{mA}$ $I_C = -1\text{A}$, $I_B = -100\text{mA}$ $I_C = -1\text{A}$, $I_B = -50\text{mA}$ $I_C = -2\text{A}$, $I_B = -200\text{mA}$
Base-Emitter Saturation Voltage (Note 12)	$V_{BE(SAT)}$	—	-890	-1000	mV	$I_C = -2\text{A}$, $I_B = -200\text{mA}$
Base-Emitter Turn-on Voltage (Note 12)	$V_{BE(ON)}$	—	-840	-950	mV	$I_C = -2\text{A}$, $V_{CE} = -2\text{V}$
Transitional Frequency	f_T	—	142	—	MHz	$I_E = -100\text{mA}$, $V_{CE} = -10\text{V}$ $f = 50\text{MHz}$
Input Capacitance	C_{IBO}	—	291	400	pF	$V_{EB} = -0.5\text{V}$, $f = 1\text{MHz}$,
Output Capacitance	C_{OBO}	—	23.5	40	pF	$V_{CB} = -10\text{V}$, $f = 1\text{MHz}$,
Delay Time	t_D	—	24.7	—	ns	$I_C = -500\text{mA}$, $V_{CC} = -10\text{V}$, $I_{B1} = -I_{B2} = -50\text{mA}$ $R_B = 100\Omega$, $R_C = 20\Omega$
Rise Time	t_R	—	22.4	—	ns	
Storage Time	t_S	—	660	—	ns	
Fall Time	t_F	—	107	—	ns	

Note: 12. Measured under pulsed conditions. Pulse width $\leq 300\mu\text{s}$. Duty cycle $\leq 2\%$.

Typical Electrical Characteristics (@T_A = +25°C, unless otherwise specified.)

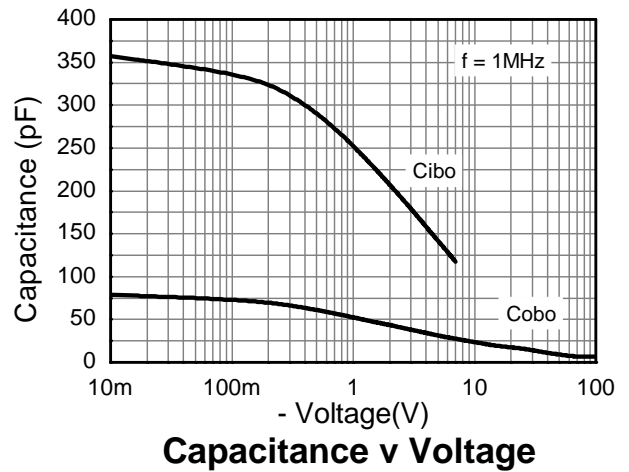
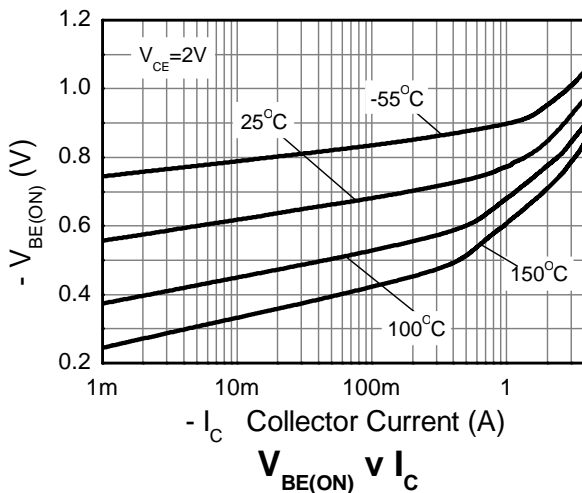
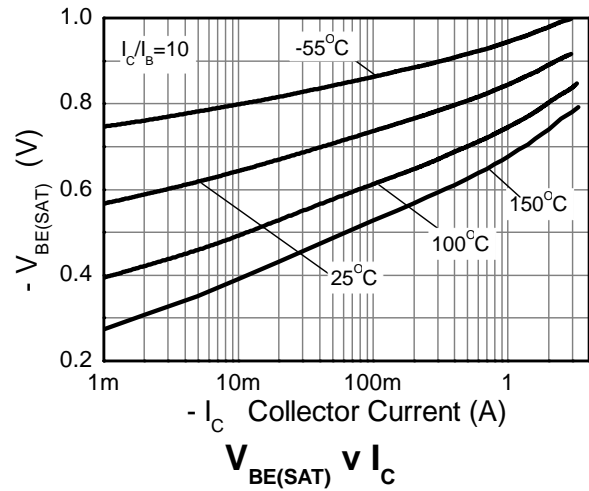
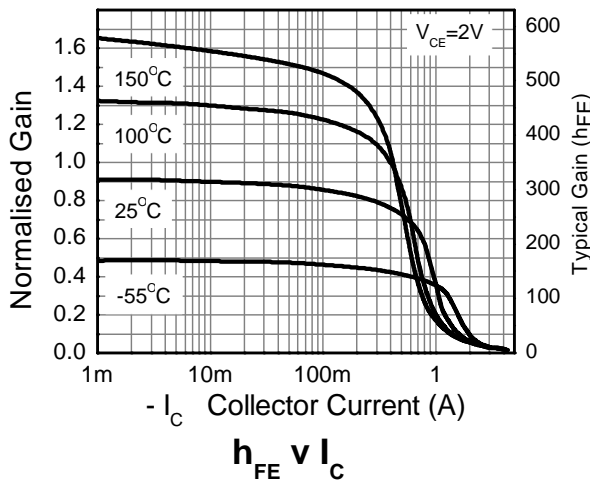
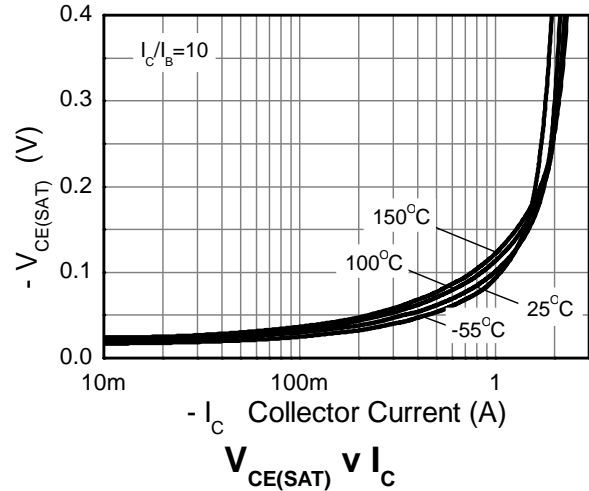
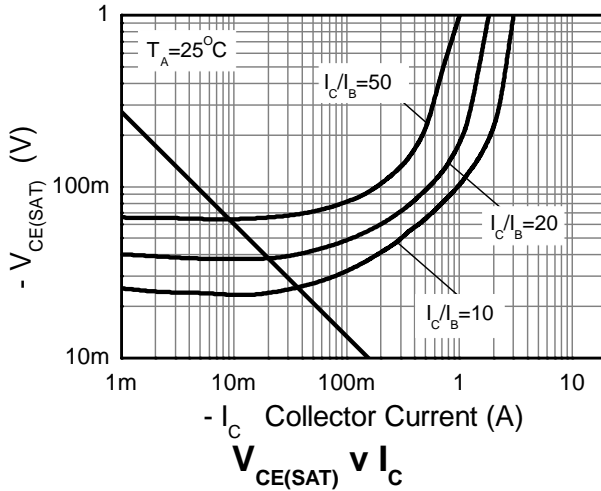

Package Outline Dimensions

Please see <http://www.diodes.com/package-outlines.html> for the latest version.

SOT89

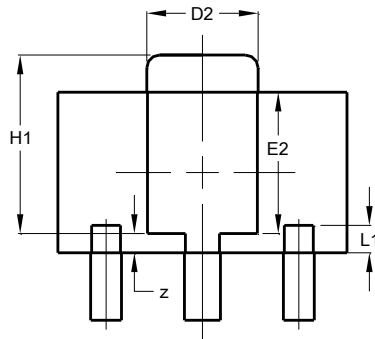
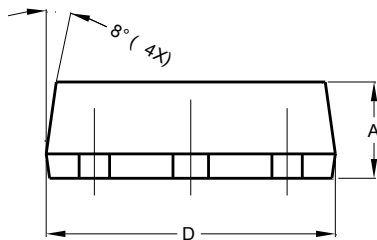
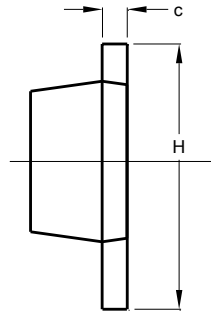
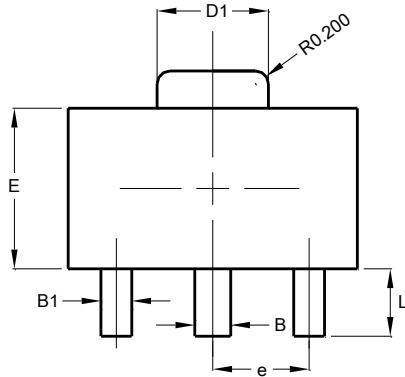

SOT89			
Dim	Min	Max	Typ
A	1.40	1.60	1.50
B	0.50	0.62	0.56
B1	0.42	0.54	0.48
c	0.35	0.43	0.38
D	4.40	4.60	4.50
D1	1.62	1.83	1.733
D2	1.61	1.81	1.71
E	2.40	2.60	2.50
E2	2.05	2.35	2.20
e	-	-	1.50
H	3.95	4.25	4.10
H1	2.63	2.93	2.78
L	0.90	1.20	1.05
L1	0.327	0.527	0.427
z	0.20	0.40	0.30
All Dimensions in mm			

Suggested Pad Layout

Please see <http://www.diodes.com/package-outlines.html> for the latest version.

SOT89

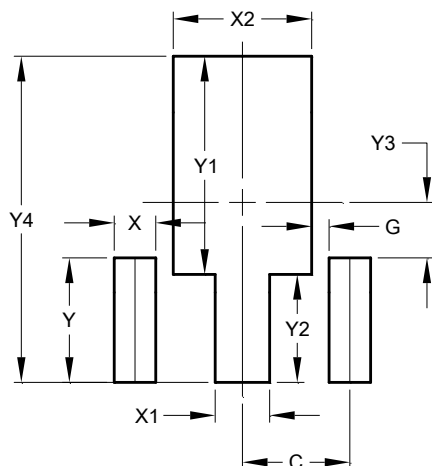

Dimensions	Value (in mm)
C	1.500
G	0.244
X	0.580
X1	0.760
X2	1.933
Y	1.730
Y1	3.030
Y2	1.500
Y3	0.770
Y4	4.530

Note: For high voltage applications, the appropriate industry sector guidelines should be considered with regards to creepage and clearance distances between device Terminals and PCB tracking.

IMPORTANT NOTICE

DIODES INCORPORATED MAKES NO WARRANTY OF ANY KIND, EXPRESS OR IMPLIED, WITH REGARDS TO THIS DOCUMENT, INCLUDING, BUT NOT LIMITED TO, THE IMPLIED WARRANTIES OF MERCHANTABILITY AND FITNESS FOR A PARTICULAR PURPOSE (AND THEIR EQUIVALENTS UNDER THE LAWS OF ANY JURISDICTION).

Diodes Incorporated and its subsidiaries reserve the right to make modifications, enhancements, improvements, corrections or other changes without further notice to this document and any product described herein. Diodes Incorporated does not assume any liability arising out of the application or use of this document or any product described herein; neither does Diodes Incorporated convey any license under its patent or trademark rights, nor the rights of others. Any Customer or user of this document or products described herein in such applications shall assume all risks of such use and will agree to hold Diodes Incorporated and all the companies whose products are represented on Diodes Incorporated website, harmless against all damages.

Diodes Incorporated does not warrant or accept any liability whatsoever in respect of any products purchased through unauthorized sales channel. Should Customers purchase or use Diodes Incorporated products for any unintended or unauthorized application, Customers shall indemnify and hold Diodes Incorporated and its representatives harmless against all claims, damages, expenses, and attorney fees arising out of, directly or indirectly, any claim of personal injury or death associated with such unintended or unauthorized application.

Products described herein may be covered by one or more United States, international or foreign patents pending. Product names and markings noted herein may also be covered by one or more United States, international or foreign trademarks.

This document is written in English but may be translated into multiple languages for reference. Only the English version of this document is the final and determinative format released by Diodes Incorporated.

LIFE SUPPORT

Diodes Incorporated products are specifically not authorized for use as critical components in life support devices or systems without the express written approval of the Chief Executive Officer of Diodes Incorporated. As used herein:

A. Life support devices or systems are devices or systems which:

1. are intended to implant into the body, or
2. support or sustain life and whose failure to perform when properly used in accordance with instructions for use provided in the labeling can be reasonably expected to result in significant injury to the user.

B. A critical component is any component in a life support device or system whose failure to perform can be reasonably expected to cause the failure of the life support device or to affect its safety or effectiveness.

Customers represent that they have all necessary expertise in the safety and regulatory ramifications of their life support devices or systems, and acknowledge and agree that they are solely responsible for all legal, regulatory and safety-related requirements concerning their products and any use of Diodes Incorporated products in such safety-critical, life support devices or systems, notwithstanding any devices- or systems-related information or support that may be provided by Diodes Incorporated. Further, Customers must fully indemnify Diodes Incorporated and its representatives against any damages arising out of the use of Diodes Incorporated products in such safety-critical, life support devices or systems.

Copyright © 2016, Diodes Incorporated

www.diodes.com

Mouser Electronics

Authorized Distributor

Click to View Pricing, Inventory, Delivery & Lifecycle Information:

[Diodes Incorporated:](#)

[ZXTP19100CZTA](#)