

# ZXMS6004DG

## 60V N-channel self protected enhancement mode Intellifet MOSFET

### Summary

Continuous drain source voltage	60 V
On-state resistance	500 mΩ
Nominal load current ( $V_{IN} = 5V$ )	1.3 A
Clamping energy	490mJ

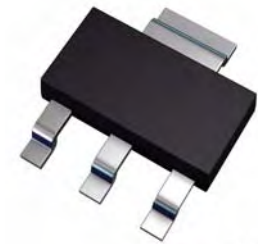

SOT223

### Description

The ZXMS6004DG is a self protected low side MOSFET with logic level input. It integrates over-temperature, over-current, over-voltage (active clamp) and ESD protected logic level functionality. The ZXMS6004DG is ideal as a general purpose switch driven from 3.3V or 5V microcontrollers in harsh environments where standard MOSFETs are not rugged enough.

### Features

- Compact high power dissipation package
- Low input current
- Logic Level Input (3.3V and 5V)
- Short circuit protection with auto restart
- Over voltage protection (active clamp)
- Thermal shutdown with auto restart
- Over-current protection
- Input Protection (ESD)
- High continuous current rating

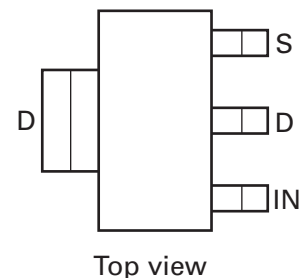

### Ordering information

Device	Part mark	Reel size (inches)	Tape width (mm)	Quantity per reel
ZXMS66004DGTA	ZXMS 6004D	7	12 embossed	3,000 units

## Functional block diagram

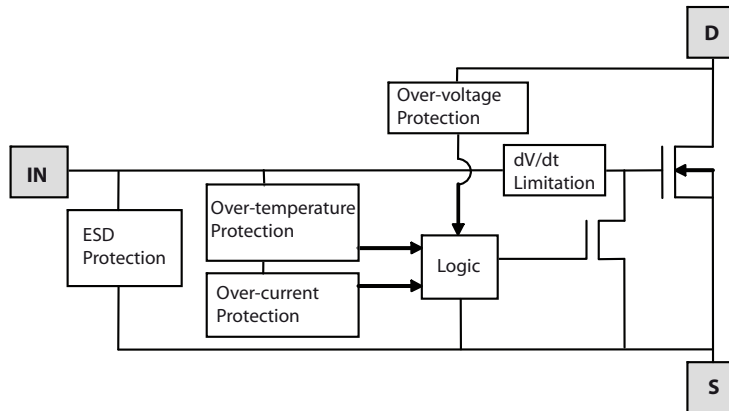

## Application information

- Especially suited for loads with a high in-rush current such as lamps and motors.
- All types of resistive, inductive and capacitive loads in switching applications.
- $\mu\text{C}$  compatible power switch for 12V and 24V DC applications.
- Automotive rated.
- Replaces electromechanical relays and discrete circuits.
- Linear Mode capability - the current-limiting protection circuitry is designed to de-activate at low  $V_{\text{DS}}$  to minimise on state power dissipation. The maximum DC operating current is therefore determined by the thermal capability of the package/board combination, rather than by the protection circuitry. This does not compromise the product's ability to self-protect at low  $V_{\text{DS}}$ .

## Absolute maximum ratings

Parameter	Symbol	Limit	Unit
Continuous Drain-Source voltage	$V_{DS}$	60	V
Drain-Source voltage for short circuit protection	$V_{DS(SC)}$	36	V
Continuous input voltage	$V_{IN}$	-0.5 ... +6	V
Continuous input current -0.2V ≤ $V_{IN}$ ≤ 6V $V_{IN}$ < -0.2V or $V_{IN}$ > 6V	$I_{IN}$	No limit $ I_{IN}  \leq 2$	mA
Operating temperature range	$T_j$	-40 to +150	°C
Storage temperature range	$T_{stg}$	-55 to +150	°C
Power dissipation at $T_A = 25^\circ\text{C}$ <sup>(a)</sup>	$P_D$	1.3	W
Linear derating factor		10.4	mW/°C
Power dissipation at $T_A = 25^\circ\text{C}$ <sup>(b)</sup>	$P_D$	3.0	W
Linear derating factor		24	mW/°C
Pulsed drain current @ $V_{IN}=3.3\text{V}$	$I_{DM}$	2	A
Pulsed drain current @ $V_{IN}=5\text{V}$	$I_{DM}$	2.5	A
Continuous source current (Body Diode) <sup>(a)</sup>	$I_S$	1	A
Pulsed dource current (Body Diode)	$I_{SM}$	5	A
Unclamped single pulse inductive energy, $T_j=25^\circ\text{C}$ , $I_D=0.5\text{A}$ , $V_{DD}=24\text{V}$	$E_{AS}$	490	mJ
Electrostatic discharge (Human body model)	$V_{ESD}$	4000	V
Charged device model	$V_{CDM}$	1000	V

## Thermal resistance

Parameter	Symbo	Value	Unit
Junction to ambient <sup>(a)</sup>	$R_{\theta JA}$	96	°C/W
Junction to ambient <sup>(b)</sup>	$R_{\theta JA}$	42	°C/W
Junction to case <sup>(c)</sup>	$R_{\theta JC}$	12	°C/W

### NOTES

(a) For a device surface mounted on a 15mm x 15mm single sided 1oz weight copper on 1.6mm FR4 board, in still air conditions.

(b) For a device surface mounted on 50mm x 50mm single sided 2oz weight copper on 1.6mm FR4 board in still air conditions.

(c) Thermal resistance from junction to the mounting surface of the drain pin.

# ZXMS6004DG

## Recommended operating conditions

The ZXMS6004DG is optimised for use with  $\mu\text{C}$  operating from 3.3V and 5V supplies.

Symbol	Description	Min	Max	Units
$V_{\text{IN}}$	Input voltage range	0	5.5	V
$T_{\text{A}}$	Ambient temperature range	-40	125	$^{\circ}\text{C}$
$V_{\text{IH}}$	High level input voltage for MOSFET to be on	3	5.5	V
$V_{\text{IL}}$	Low level input voltage for MOSFET to be off	0	0.7	V
$V_{\text{P}}$	Peripheral supply voltage (voltage to which load is referred)	0	36	V

## Characteristics

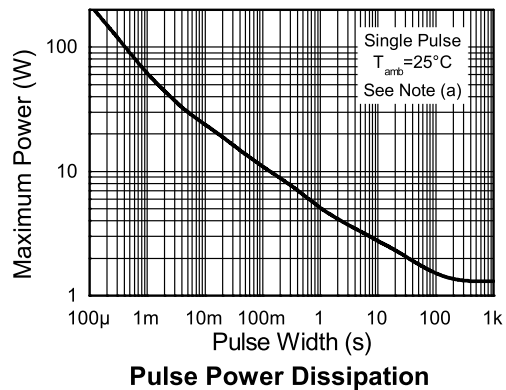
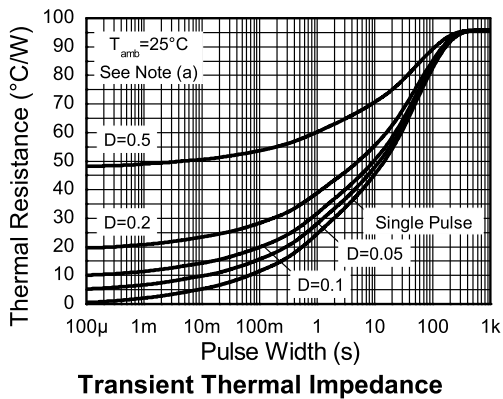
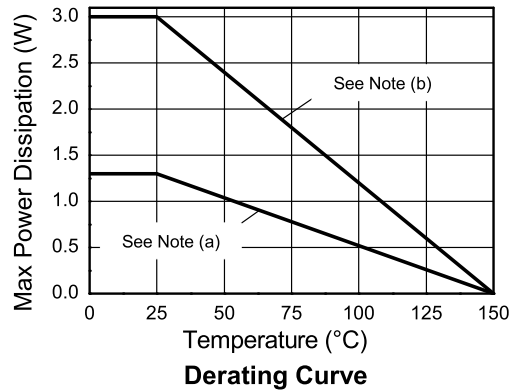
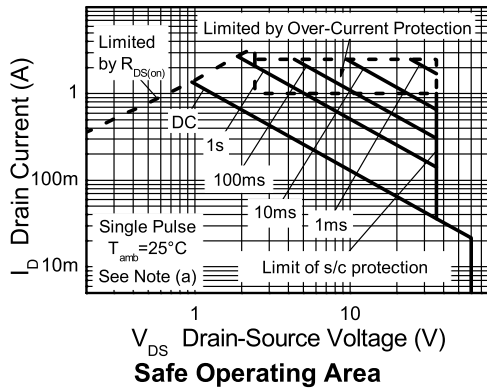

# ZXMS6004DG

Electrical characteristics (at  $T_{amb} = 25^{\circ}\text{C}$  unless otherwise stated).

Parameter	Symbol	Min	Typ	Max	Unit	Conditions
<b>Static Characteristics</b>						
Drain-Source clamp voltage	$V_{DS(AZ)}$	60	65	70	V	$I_D=10\text{mA}$
Off-state drain Ccurrent	$I_{DSS}$			500	nA	$V_{DS}=12\text{V}, V_{IN}=0\text{V}$
Off-state drain current	$I_{DSS}$			1	$\mu\text{A}$	$V_{DS}=36\text{V}, V_{IN}=0\text{V}$
Input threshold voltage	$V_{IN(th)}$	0.7	1	1.5	V	$V_{DS}=V_{GS}, I_D=1\text{mA}$
Input current	$I_{IN}$		60	100	$\mu\text{A}$	$V_{IN}=+3\text{V}$
Input current	$I_{IN}$		120	200	$\mu\text{A}$	$V_{IN}=+5\text{V}$
Input current while over temperature active				400	$\mu\text{A}$	$V_{IN}=+5\text{V}$
Static Drain-Source on-state resistance	$R_{DS(on)}$		400	600	$\text{m}\Omega$	$V_{IN}=+3\text{V}, I_D=0.5\text{A}$
Static Drain-Source on-state resistance	$R_{DS(on)}$		350	500	$\text{m}\Omega$	$V_{IN}=+5\text{V}, I_D=0.5\text{A}$
Continuous drain current <sup>(a)</sup>	$I_D$	0.9			A	$V_{IN}=3\text{V}; T_A=25^{\circ}\text{C}$
Continuous drain cCurrent (a)	$I_D$	1.0			A	$V_{IN}=5\text{V}; T_A=25^{\circ}\text{C}$
Continuous drain current <sup>(b)</sup>	$I_D$	1.2			A	$V_{IN}=3\text{V}; T_A=25^{\circ}\text{C}$
Continuous drain current <sup>(b)</sup>	$I_D$	1.3			A	$V_{IN}=5\text{V}; T_A=25^{\circ}\text{C}$
Current limit	$I_{D(LIM)}$	0.7	1.7		A	$V_{IN}=+3\text{V},$
Current limit <sup>(c)</sup>	$I_{D(LIM)}$	1	2.2		A	$V_{IN}=+5\text{V}$
<b>Dynamic characteristics</b>						
Turn-on delay time	$t_{d(on)}$		5		$\mu\text{s}$	$V_{DD}=12\text{V}, I_D=0.5\text{A},$ $V_{GS}=5\text{V}$
Rise time	$t_r$		10		$\mu\text{s}$	
Turn-off delay time	$t_{d(off)}$		45		$\mu\text{s}$	
Fall time	$f_f$		15		$\mu\text{s}$	

**Notes:**

(d) The drain current is restricted only when the device is in saturation (see graph 'typical output characteristic'). This allows the device to be used in the fully on state without interference from the current limit. The device is fully protected at all drain currents, as the low power dissipation generated outside saturation makes current limit unnecessary.

# ZXMS6004DG

## Electrical characteristics - continued

Parameter	Symbol	Min	Typ	Max	Unit	Conditions
<b>Over-temperature protection</b>						
Thermal overload trip temperature <sup>(a)</sup>	TJT	150	175		°C	
Thermal hysteresis <sup>(a)</sup>			10		°C	

**Note:**

(a) Over-temperature protection is designed to prevent device destruction under fault conditions. Fault conditions are considered as "outside" normal operating range, so this part is not designed to withstand over-temperature for extended periods..

## Typical characteristics

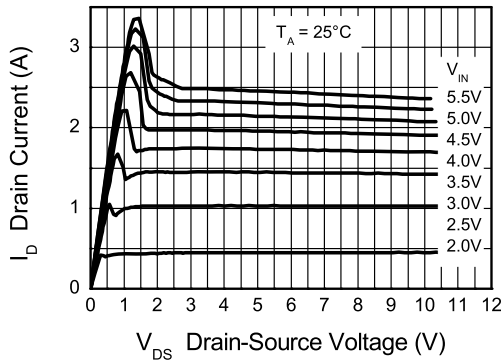

**Typical Output Characteristic**

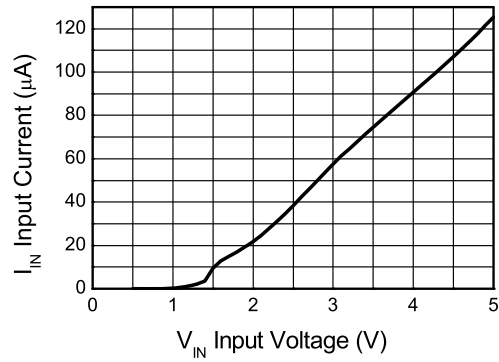

**Input Current vs Input Voltage**

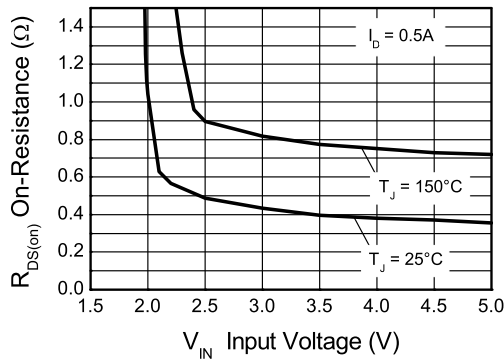

**On-Resistance vs Input Voltage**

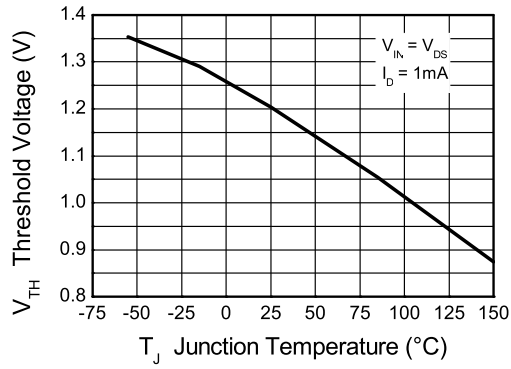

**Threshold Voltage vs Temperature**

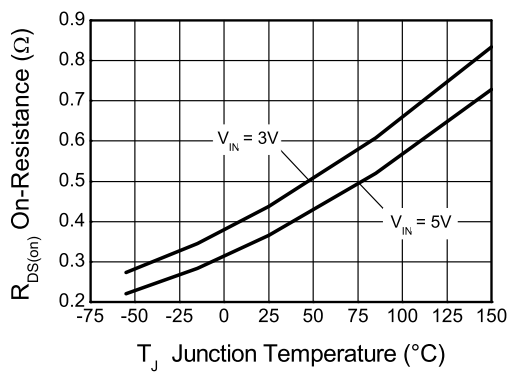

**On-Resistance vs Temperature**

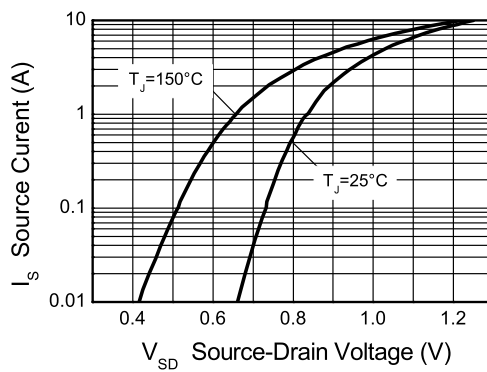

**Reverse Diode Characteristic**

# ZXMS6004DG

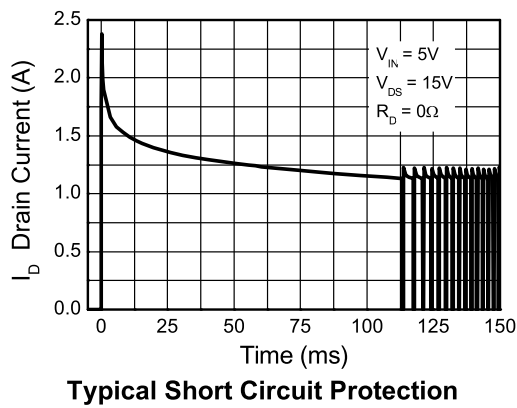
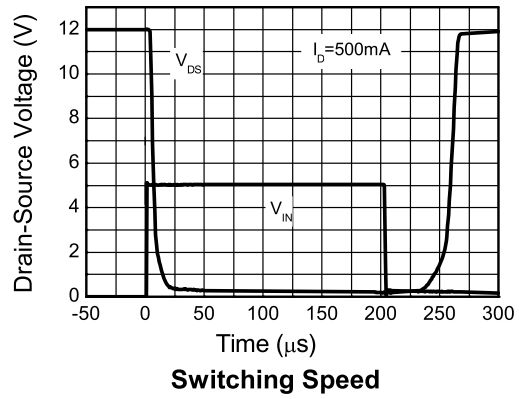
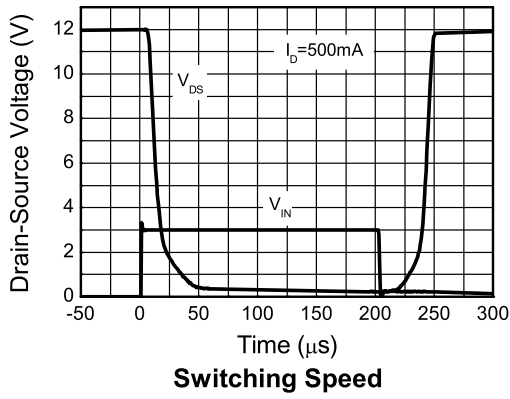



# ZXMS6004DG

## Package information - SOT223

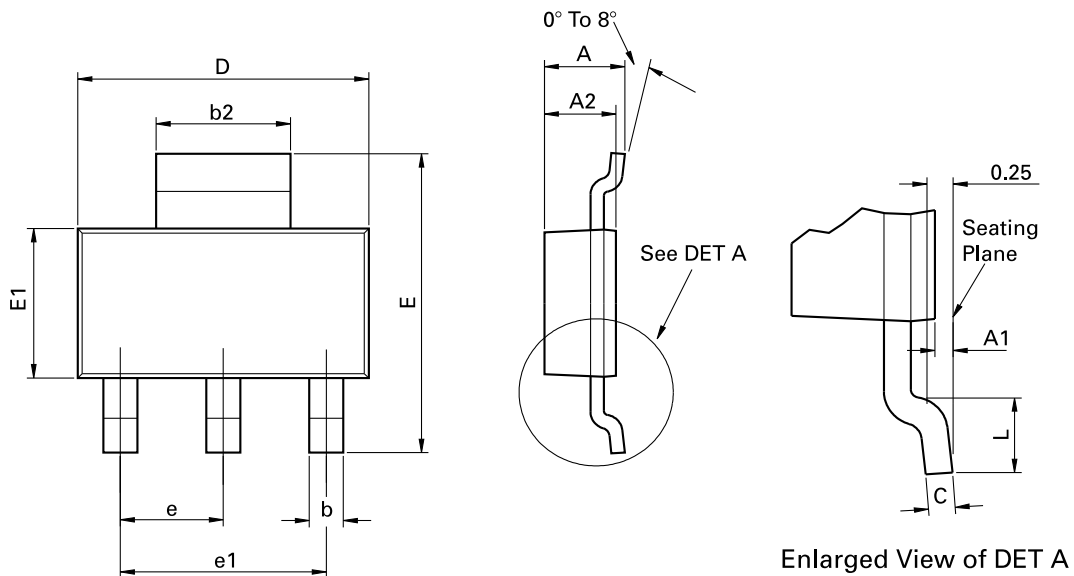

Conforms to JEDEC TO-261 AA Issue B

Dim.	Millimeters		Inches		Dim.	Millimeters		Inches	
	Min.	Max.	Min.	Max.		Min.	Max.	Min.	Max.
A	-	1.8	-	0.071	D	6.30	6.70	0.248	0.264
A1	0.02	0.1	0.0008	0.004	e	2.30 BSC		0.0905 BSC	
A2	1.55	1.65	0.0610	0.0649	e1	4.60 BSC		0.181 BSC	
b	0.66	0.84	0.026	0.033	E	6.70	7.30	0.264	0.287
b2	2.90	3.10	0.114	0.122	E1	3.30	3.70	0.130	0.146
C	0.23	0.33	0.009	0.013	L	0.90	-	0.355	-

**Note:** Controlling dimensions are in millimeters. Approximate dimensions are provided in inches

# ZXMS6004DG

## Definitions

### Product change

Diodes Incorporated reserves the right to alter, without notice, specifications, design, price or conditions of supply of any product or service. Customers are solely responsible for obtaining the latest relevant information before placing orders.

### Applications disclaimer

The circuits in this design/application note are offered as design ideas. It is the responsibility of the user to ensure that the circuit is fit for the user's application and meets with the user's requirements. No representation or warranty is given and no liability whatsoever is assumed by Diodes Inc. with respect to the accuracy or use of such information, or infringement of patents or other intellectual property rights arising from such use or otherwise. Diodes Inc. does not assume any legal responsibility or will not be held legally liable (whether in contract, tort (including negligence), breach of statutory duty, restriction or otherwise) for any damages, loss of profit, business, contract, opportunity or consequential loss in the use of these circuit applications, under any circumstances.

### Life support

Diodes Zetex products are specifically not authorized for use as critical components in life support devices or systems without the express written approval of the Chief Executive Officer of Diodes Incorporated. As used herein:

A. Life support devices or systems are devices or systems which:

1. are intended to implant into the body

or

2. support or sustain life and whose failure to perform when properly used in accordance with instructions for use provided in the labeling can be reasonably expected to result in significant injury to the user.

B. A critical component is any component in a life support device or system whose failure to perform can be reasonably expected to cause the failure of the life support device or to affect its safety or effectiveness.

### Reproduction

The product specifications contained in this publication are issued to provide outline information only which (unless agreed by the company in writing) may not be used, applied or reproduced for any purpose or form part of any order or contract or be regarded as a representation relating to the products or services concerned.

### Terms and Conditions

All products are sold subjects to Diodes Inc. terms and conditions of sale, and this disclaimer (save in the event of a conflict between the two when the terms of the contract shall prevail) according to region, supplied at the time of order acknowledgement.

For the latest information on technology, delivery terms and conditions and prices, please contact your nearest Diodes Zetex sales office.

### Quality of product

Diodes Zetex Semiconductors Limited is an ISO 9001 and TS16949 certified semiconductor manufacturer.

To ensure quality of service and products we strongly advise the purchase of parts directly from Diodes Inc. or one of our regionally authorized distributors. For a complete listing of authorized distributors please visit: [www.zetex.com](http://www.zetex.com) or [www.diodes.com](http://www.diodes.com)

Diodes Inc. does not warrant or accept any liability whatsoever in respect of any parts purchased through unauthorized sales channels.

### ESD (Electrostatic discharge)

Semiconductor devices are susceptible to damage by ESD. Suitable precautions should be taken when handling and transporting devices. The possible damage to devices depends on the circumstances of the handling and transporting, and the nature of the device. The extent of damage can vary from immediate functional or parametric malfunction to degradation of function or performance in use over time. Devices suspected of being affected should be replaced.

### Green compliance

Diodes Inc. is committed to environmental excellence in all aspects of its operations which includes meeting or exceeding regulatory requirements with respect to the use of hazardous substances. Numerous successful programs have been implemented to reduce the use of hazardous substances and/or emissions.

All Diodes Zetex components are compliant with the RoHS directive, and through this it is supporting its customers in their compliance with WEEE and ELV directives.

### Product status key:

"Preview"	Future device intended for production at some point. Samples may be available
"Active"	Product status recommended for new designs
"Last time buy (LTB)"	Device will be discontinued and last time buy period and delivery is in effect
"Not recommended for new designs"	Device is still in production to support existing designs and production
"Obsolete"	Production has been discontinued

### Datasheet status key:

"Draft version"	This term denotes a very early datasheet version and contains highly provisional information, which may change in any manner without notice.
"Provisional version"	This term denotes a pre-release datasheet. It provides a clear indication of anticipated performance. However, changes to the test conditions and specifications may occur, at any time and without notice.
"Issue"	This term denotes an issued datasheet containing finalized specifications. However, changes to specifications may occur, at any time and without notice.

## Sales offices

The Americas	Europe	Taiwan	Shanghai	Shenzhen	Korea
3050 E. Hillcrest Drive Westlake Village, CA 91362-3154 Tel: (+1) 805 446 4800 Fax: (+1) 805 446 4850	Kustermann-Park Balanstraße 59, D-81541 München Germany Tel: (+49) 894 549 490 Fax: (+49) 894 549 4949	7F, No. 50, Min Chuan Road Hsin-Tien Taipei, Taiwan Tel: (+886) 289 146 000 Fax: (+886) 289 146 639	Rm. 606, No.1158 Changning Road Shanghai, China Tel: (+86) 215 241 4882 Fax (+86) 215 241 4891	ANLIAN Plaza, #4018 Jintian Road Futian CBD, Shenzhen, China Tel: (+86) 755 882 849 88 Fax: (+86) 755 882 849 99	6 Floor, Changhwa B/D, 1005-5 Yeongtong-dong, Yeongtong-gu, Suwon-si, Gyeonggi-do, Korea 443-813 Tel: (+82) 312 731 884 Fax: (+82) 312 731 885

# Mouser Electronics

Authorized Distributor

Click to View Pricing, Inventory, Delivery & Lifecycle Information:

[Diodes Incorporated:](#)

[ZXMS6004DGTA](#)