

## Product Summary

$V_{(BR)DSS}$	$R_{DS(ON)}$	$I_D$ $T_A = +25^\circ\text{C}$
450V	50Ω @ $V_{GS} = 10\text{V}$	140mA

## Description

This new generation trench MOSFET features a unique structure combining the benefits of low on-resistance and fast switching, making it ideal for high efficiency power management applications.

## Applications

- Off-line Power Supply Start-up Circuitry

## Features and Benefits

- High Voltage
- Low On-resistance
- Fast Switching Speed
- Low Gate Drive
- Low Threshold
- Lead-Free Finish; RoHS Compliant (Notes 1 & 2)**
- Halogen and Antimony Free. "Green" Device (Note 3)**
- Qualified to AEC-Q101 Standards for High Reliability**

## Mechanical Data

- Case: SOT223
- Case Material: Molded Plastic, "Green" Molding Compound; UL Flammability Classification Rating 94V-0
- Moisture Sensitivity: Level 1 per J-STD-020
- Terminals: Matte Tin Finish
- Weight: 0.112 grams (Approximate)

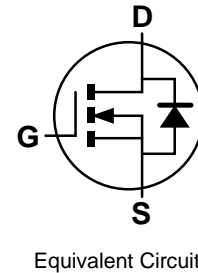
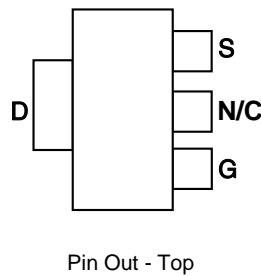
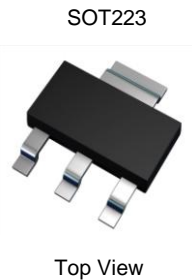

## Ordering Information (Note 4)

Part Number	Marking	Reel size (inches)	Tape width (mm)	Quantity per reel
ZXMN0545G4TA	ZXMN0545	7	12	1,000
ZXMN0545G4TC	ZXMN0545	13	12	4,000

- Notes:
- EU Directive 2002/95/EC (RoHS) & 2011/65/EU (RoHS 2) compliant. All applicable RoHS exemptions applied.
  - See [http://www.diodes.com/quality/lead\\_free.html](http://www.diodes.com/quality/lead_free.html) for more information about Diodes Incorporated's definitions of Halogen- and Antimony-free, "Green" and Lead-free.
  - Halogen- and Antimony-free "Green" products are defined as those which contain <900ppm bromine, <900ppm chlorine (<1500ppm total Br + Cl) and <1000ppm antimony compounds.
  - For packaging details, go to our website at <http://www.diodes.com/products/packages.html>.

## Marking Information

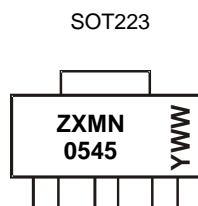

ZXMN0545 = Product Type Marking Code  
 YWW = Date Code Marking  
 Y or  $\bar{Y}$  = Last Digit of Year (ex: 5 = 2015)  
 WW or  $\bar{W}W$  = Week Code (01~53)

**Maximum Ratings** (@T<sub>A</sub> = +25°C, unless otherwise specified.)

Characteristic	Symbol	Value	Unit
Drain-Source Voltage	V <sub>DSS</sub>	450	V
Gate-Source Voltage	V <sub>GSS</sub>	±20	V
Continuous Drain Current (V <sub>GS</sub> = 10V; T <sub>A</sub> = +25°C) (Note 5)	I <sub>D</sub>	140	mA
Pulsed Drain Current (Note 7)	I <sub>DM</sub>	600	mA
Continuous Source Current (Body Diode) (Note 6)	I <sub>S</sub>	140	mA
Pulsed Source Current (Body Diode) (Note 7)	I <sub>SM</sub>	600	mA

**Thermal Characteristics** (@T<sub>A</sub> = +25°C, unless otherwise specified.)

Characteristic	Symbol	Value	Unit
Power Dissipation at T <sub>A</sub> = +25°C (Note 5)	P <sub>D</sub>	2.0	W
Linear Derating Factor		1.6	mW/°C
Thermal Resistance, Junction to Ambient (Note 5)	R <sub>θJA</sub>	62.5	°C/W
Thermal Resistance, Junction to Ambient (Note 6)	R <sub>θJA</sub>	32	°C/W
Operating and Storage Temperature Range	T <sub>J</sub> , T <sub>STG</sub>	-55 to +150	°C

**Electrical Characteristics** (@T<sub>A</sub> = +25°C, unless otherwise specified.)

Characteristic	Symbol	Min	Typ	Max	Unit	Test Condition
<b>OFF CHARACTERISTICS</b>						
Drain-Source Breakdown Voltage	BV <sub>DSS</sub>	450	-	-	V	V <sub>GS</sub> = 0V, I <sub>D</sub> = 1mA
Zero Gate Voltage Drain Current	I <sub>DSS</sub>	-	-	10 400	µA	V <sub>DS</sub> = 450V, V <sub>GS</sub> = 0V V <sub>DS</sub> = 405V, V <sub>GS</sub> = 0V, T = +125°C
Gate-Source Leakage	I <sub>GSS</sub>	-	-	20	nA	V <sub>GS</sub> = ±20V, V <sub>DS</sub> = 0V
<b>ON CHARACTERISTICS</b>						
Gate Threshold Voltage	V <sub>GS(TH)</sub>	1	-	3	V	V <sub>DS</sub> = V <sub>GS</sub> , I <sub>D</sub> = 1mA
Static Drain-Source On-Resistance (Note 8)	R <sub>DS(ON)</sub>	-	-	50	Ω	V <sub>GS</sub> = 10V, I <sub>D</sub> = 100mA
Forward Transconductance (Notes 8 & 10)	g <sub>fs</sub>	100	-	-	mS	V <sub>DS</sub> = 25V, I <sub>D</sub> = 100mA
On-State Drain Current (Note 8)	I <sub>D(ON)</sub>	150	-	-	mA	V <sub>DS</sub> = 25V, V <sub>GS</sub> = 10V
<b>DYNAMIC CHARACTERISTICS</b> (Note 11)						
Input Capacitance (Note 10)	C <sub>iss</sub>	-	-	70	pF	V <sub>DS</sub> = 25V, V <sub>GS</sub> = 0V, f = 1.0MHz
Output Capacitance (Note 10)	C <sub>oss</sub>	-	-	10	pF	
Reverse Transfer Capacitance (Note 10)	C <sub>rss</sub>	-	-	4	pF	
Turn-On Delay Time (Notes 9 & 10)	t <sub>D(ON)</sub>	-	-	7	ns	V <sub>DD</sub> = 25V, I <sub>D</sub> = 100mA
Turn-On Rise Time (Notes 9 & 10)	t <sub>R</sub>	-	-	7	ns	
Turn-Off Delay Time (Notes 9 & 10)	t <sub>D(OFF)</sub>	-	-	16	ns	
Turn-Off Fall Time (Notes 9 & 10)	t <sub>F</sub>	-	-	10	ns	

- Notes:
5. For a device surface mounted on 25mm x 25mm FR4 PCB with high coverage of single sided 1oz copper, in still air conditions.
  6. For a device surface mounted on FR4 PCB measured at t ≤ 5 secs.
  7. Repetitive rating - pulse width limited by maximum junction temperature. Refer to Transient Thermal Impedance graph.
  8. Measured under pulsed conditions. Pulse width ≤ 300µs. Duty cycle ≤ 2%.
  9. Switching characteristics are independent of operating junction temperature.
  10. Sample test.
  11. For design aid only, not subject to production testing.

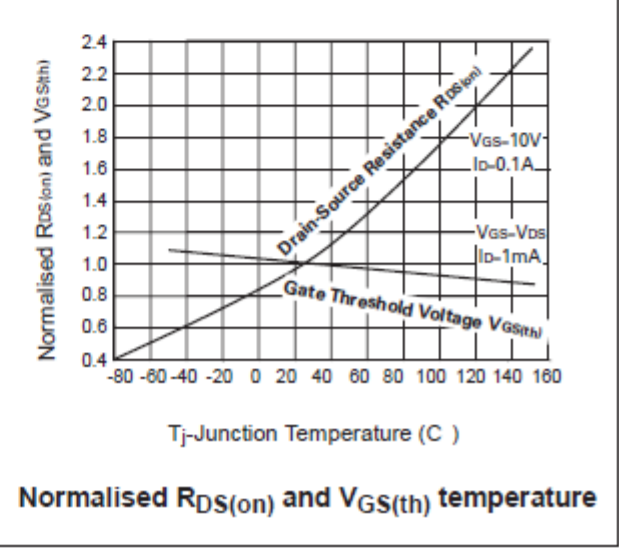
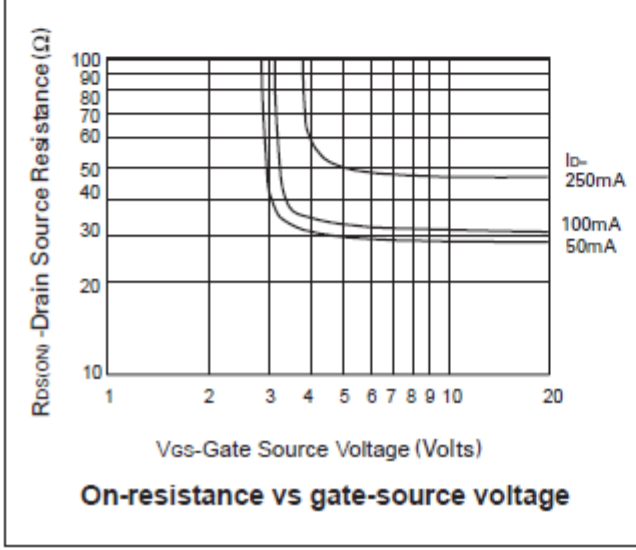
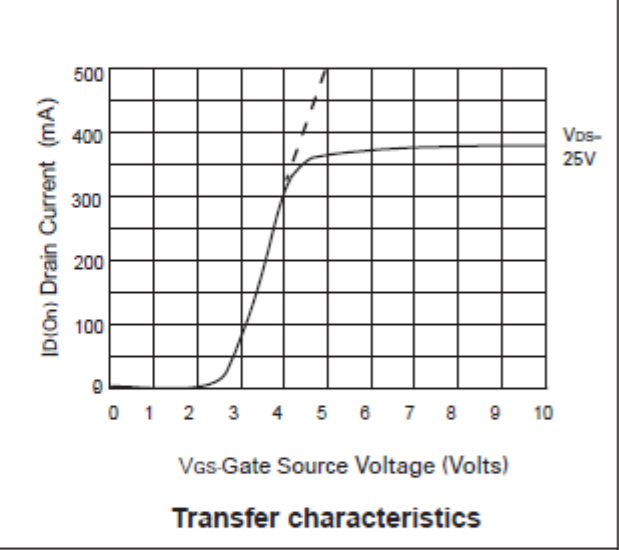
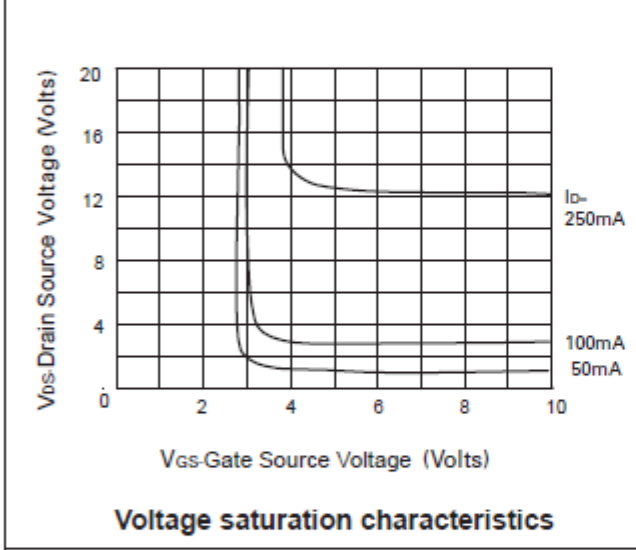
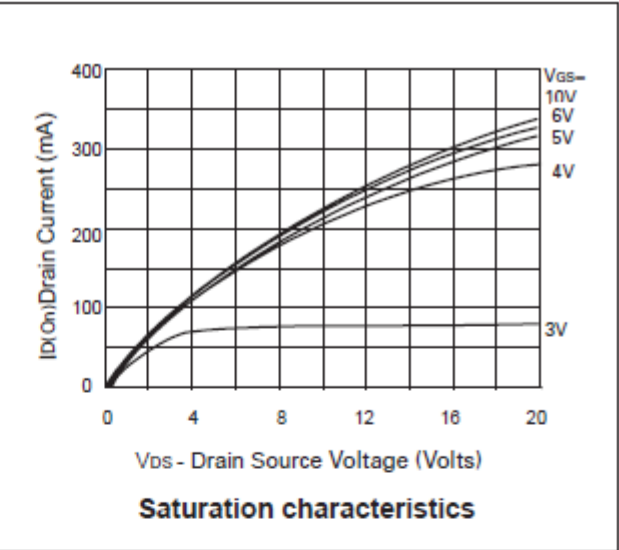
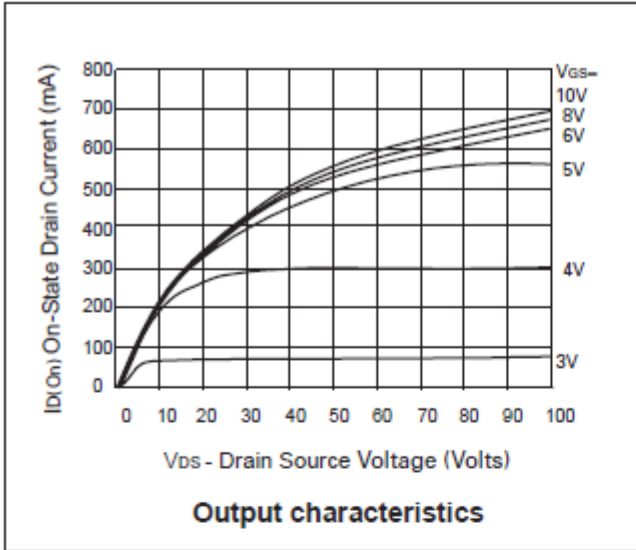

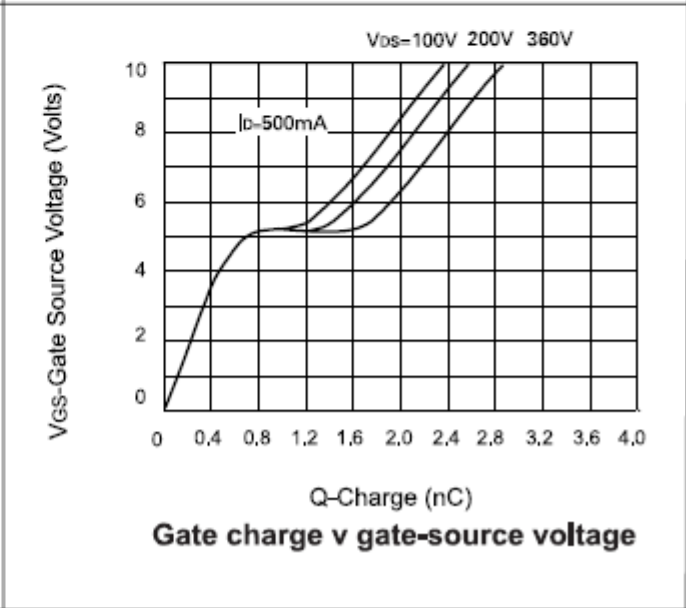
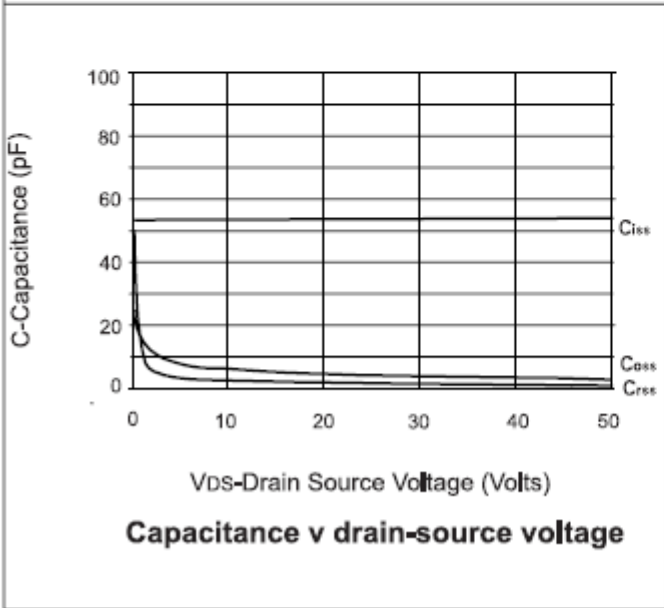
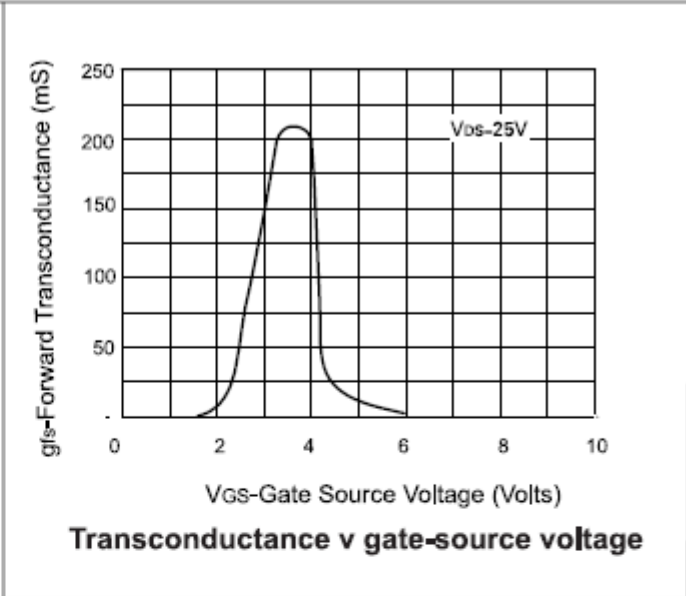
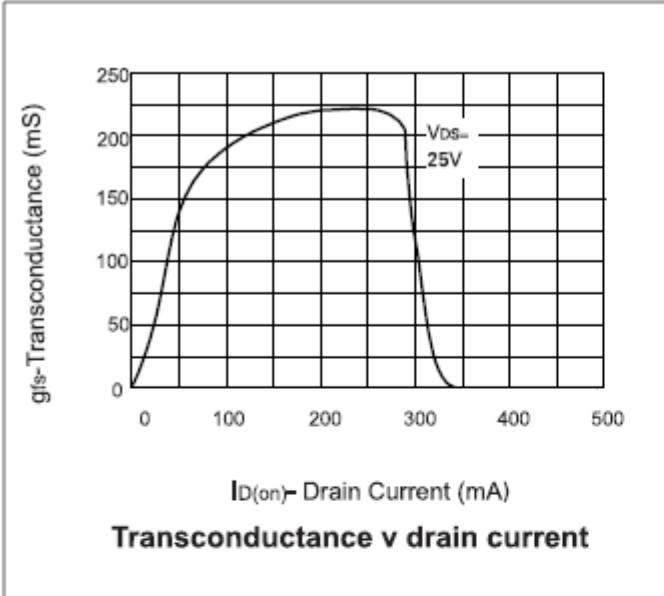

**Package Outline Dimensions**

Please see AP02002 at <http://www.diodes.com/datasheets/ap02002.pdf> for the latest version.

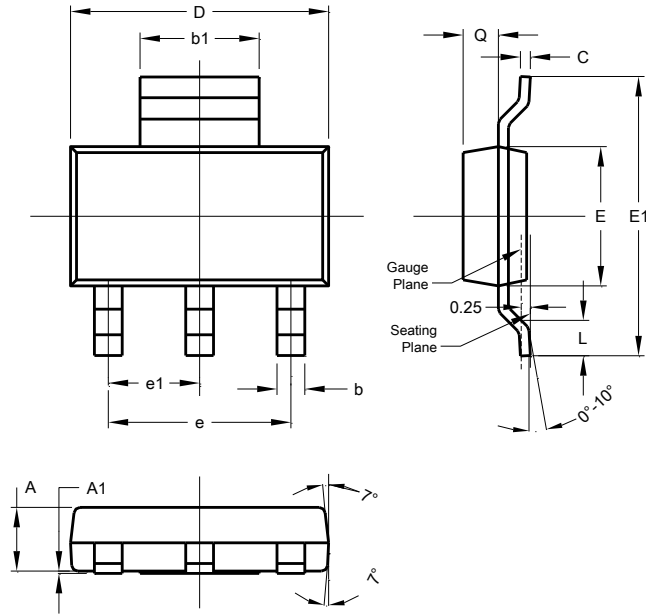

SOT223			
Dim	Min	Max	Typ
A	1.55	1.65	1.60
A1	0.010	0.15	0.05
b	0.60	0.80	0.70
b1	2.90	3.10	3.00
C	0.20	0.30	0.25
D	6.45	6.55	6.50
E	3.45	3.55	3.50
E1	6.90	7.10	7.00
e	-	-	4.60
e1	-	-	2.30
L	0.85	1.05	0.95
Q	0.84	0.94	0.89

All Dimensions in mm

**Suggested Pad Layout**

Please see AP02001 at <http://www.diodes.com/datasheets/ap02001.pdf> for the latest version.

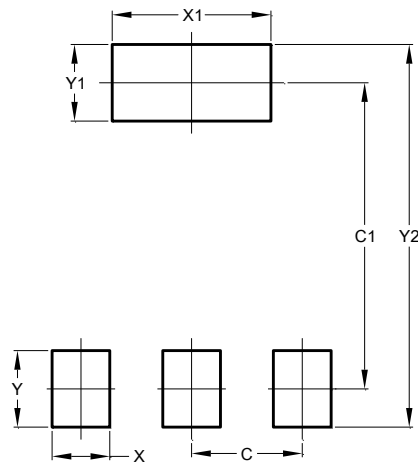

Dimensions	Value (in mm)
C	2.30
C1	6.40
X	1.20
X1	3.30
Y	1.60
Y1	1.60
Y2	8.00

**IMPORTANT NOTICE**

DIODES INCORPORATED MAKES NO WARRANTY OF ANY KIND, EXPRESS OR IMPLIED, WITH REGARDS TO THIS DOCUMENT, INCLUDING, BUT NOT LIMITED TO, THE IMPLIED WARRANTIES OF MERCHANTABILITY AND FITNESS FOR A PARTICULAR PURPOSE (AND THEIR EQUIVALENTS UNDER THE LAWS OF ANY JURISDICTION).

Diodes Incorporated and its subsidiaries reserve the right to make modifications, enhancements, improvements, corrections or other changes without further notice to this document and any product described herein. Diodes Incorporated does not assume any liability arising out of the application or use of this document or any product described herein; neither does Diodes Incorporated convey any license under its patent or trademark rights, nor the rights of others. Any Customer or user of this document or products described herein in such applications shall assume all risks of such use and will agree to hold Diodes Incorporated and all the companies whose products are represented on Diodes Incorporated website, harmless against all damages.

Diodes Incorporated does not warrant or accept any liability whatsoever in respect of any products purchased through unauthorized sales channel. Should Customers purchase or use Diodes Incorporated products for any unintended or unauthorized application, Customers shall indemnify and hold Diodes Incorporated and its representatives harmless against all claims, damages, expenses, and attorney fees arising out of, directly or indirectly, any claim of personal injury or death associated with such unintended or unauthorized application.

Products described herein may be covered by one or more United States, international or foreign patents pending. Product names and markings noted herein may also be covered by one or more United States, international or foreign trademarks.

This document is written in English but may be translated into multiple languages for reference. Only the English version of this document is the final and determinative format released by Diodes Incorporated.

**LIFE SUPPORT**

Diodes Incorporated products are specifically not authorized for use as critical components in life support devices or systems without the express written approval of the Chief Executive Officer of Diodes Incorporated. As used herein:

A. Life support devices or systems are devices or systems which:

1. are intended to implant into the body, or
2. support or sustain life and whose failure to perform when properly used in accordance with instructions for use provided in the labeling can be reasonably expected to result in significant injury to the user.

B. A critical component is any component in a life support device or system whose failure to perform can be reasonably expected to cause the failure of the life support device or to affect its safety or effectiveness.

Customers represent that they have all necessary expertise in the safety and regulatory ramifications of their life support devices or systems, and acknowledge and agree that they are solely responsible for all legal, regulatory and safety-related requirements concerning their products and any use of Diodes Incorporated products in such safety-critical, life support devices or systems, notwithstanding any devices- or systems-related information or support that may be provided by Diodes Incorporated. Further, Customers must fully indemnify Diodes Incorporated and its representatives against any damages arising out of the use of Diodes Incorporated products in such safety-critical, life support devices or systems.

Copyright © 2015, Diodes Incorporated

[www.diodes.com](http://www.diodes.com)

# Mouser Electronics

Authorized Distributor

Click to View Pricing, Inventory, Delivery & Lifecycle Information:

[Diodes Incorporated:](#)

[ZXMN0545G4TA](#)