

# MGA-31289

## 0.25W High Gain Driver Amplifier

1500 - 3000 MHz



### Data Sheet

#### Description

Avago Technologies MGA-31289 is a 0.25W high gain driver amplifier MMIC with good gain flatness, housed in a standard SOT-89 plastic package. The device features high linearity performance, excellent input and output return loss, and low noise figure. The device can be easily matched to obtain optimum power and linearity.

MGA-31289 is externally tunable to operate within 1.5GHz to 3GHz frequency range applications. With high IP3, low noise figure and wideband operation, MGA-31289 may be utilized as a driver amplifier in the transmit chain and as a second stage LNA in the receive chain.

This device uses Avago Technologies proprietary 0.25um GaAs Enhancement mode PHEMT process.

#### Pin connections and Package Marking

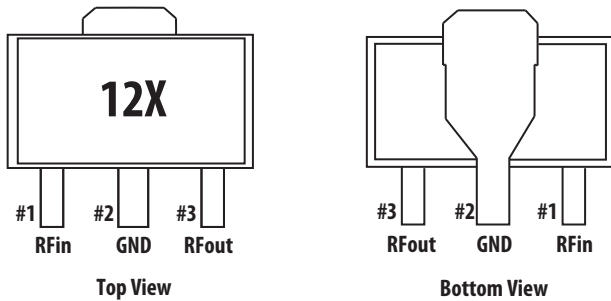

Notes:

Top View : Package marking provides orientation and identification

"12" = Device Code

"X" = Date Code character identifies month of manufacturing



**Attention: Observe precautions for handling electrostatic sensitive devices.**  
ESD Machine Model = 150 V  
ESD Human Body Model = 2000 V  
Refer to Avago Application Note A004R:  
Electrostatic Discharge, Damage and Control.

#### Features

- ROHS compliant
- Halogen free
- High linearity at low DC bias power <sup>(1)</sup>
- High Gain
- Good gain flatness
- Low noise figure
- Excellent uniformity in product specification
- SOT-89 standard package

#### Specifications

At 1.9GHz, Vd = 5V, Id = 124mA (typ) @ 25°C

- OIP3 = 41.8dBm
- Noise Figure = 2dB
- Gain = 18.70dB; Gain Flatness (+/-50MHz) = 0.1dB
- P1dB = 23.6dBm
- IRL = 16.2dB, ORL = 10.3dB

Note:

1. The MGA-31289 has a good LFOM of 14dB. Linearity Figure of Merit (LFOM) is essentially OIP3 divided by DC bias power.

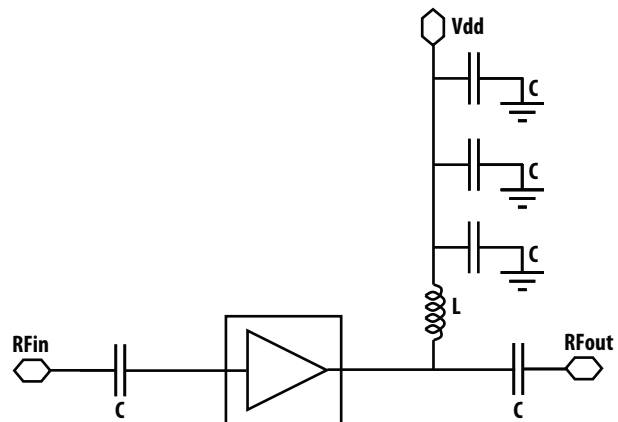

Figure 1. Simplified Schematic diagram

## MGA-31289 Absolute Maximum Rating <sup>(1)</sup> T<sub>A</sub>=25°C

Symbol	Parameter	Units	Absolute Maximum
I <sub>d,max</sub>	Drain Current	mA	165
V <sub>d,max</sub>	Device Voltage	V	5.5
P <sub>d</sub>	Power Dissipation <sup>(2)</sup>	mW	907.5
P <sub>in</sub>	CW RF Input Power	dBm	25
T <sub>j</sub>	Junction Temperature	°C	150
T <sub>stg</sub>	Storage Temperature	°C	-65 to 150

## Thermal Resistance

Thermal Resistance <sup>[3]</sup>  
(V<sub>d</sub> = 5.0V, T<sub>c</sub> = 85°C) θ<sub>jc</sub> = 50°C/W

Notes:

1. Operation of this device in excess of any of these limits may cause permanent damage.
2. This is limited by maximum V<sub>d</sub> and I<sub>d</sub>. Board temperature (T<sub>c</sub>) is 25°C. For T<sub>c</sub> > 104°C, derate the device power at 20mW per °C rise in board temperature adjacent to package bottom.
3. Thermal resistance measured using Infra-Red Microscopy Technique.

## MGA-31289 Electrical Specifications <sup>(1)</sup>

T<sub>A</sub> = 25°C, V<sub>d</sub> = 5V, unless noted

Symbol	Parameter and Test Condition	Frequency	Units	Min.	Typ.	Max.
I <sub>ds</sub>	Quiescent current	N/A	mA	101	124	143
NF	Noise Figure	1.9GHz 2.5GHz	dB	-	2 2	2.45
Gain	Gain	1.9GHz 2.5GHz	dB	17	18.7 17.7	20
OIP3 <sup>[2]</sup>	Output Third Order Intercept Point	1.9GHz 2.5GHz	dBm	38.2	41.8 41.5	-
P1dB	Output Power at 1dB Gain Compression	1.9GHz 2.5GHz	dBm	21.8	23.6 23.7	-
PAE	Power Added Efficiency at P1dB	1.9GHz 2.5GHz	%	-	36.4 34.8	-
IRL	Input Return Loss	1.9GHz 2.5GHz	dB	-	16.2 15.5	-
ORL	Output Return Loss	1.9GHz 2.5GHz	dB	-	10.3 10.8	-
ISOL	Isolation	1.9GHz 2.5GHz	dB	-	27.3 27.7	-

Notes:

1. Typical performance obtained from a test circuit described in Figure 25.
2. OIP3 test condition: F1 - F2 = 10MHz, with input power of -10dBm per tone measured at worst case side band.

## MGA-31289 Consistency Distribution Chart (1, 2)

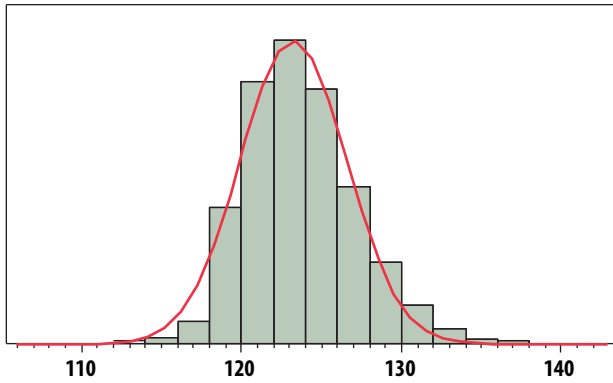

Figure 2.  $I_{dd}$  @ 1900MHz,  $V_{dd}=5V$ ,  $LSL=101mA$ ,  $Nominal=124mA$ ,  $USL=143mA$

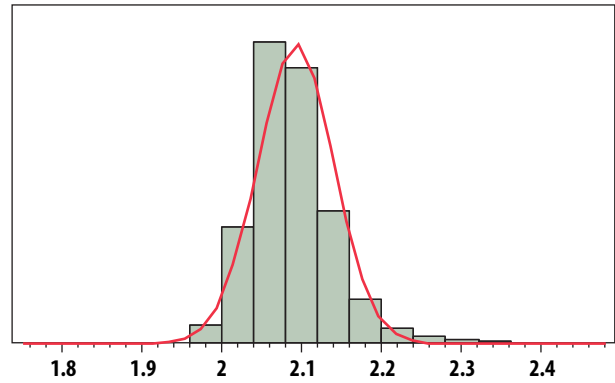

Figure 3.  $NF$  @ 900MHz,  $V_{dd} = 5V$ ,  $Nominal=2dB$ ,  $USL=2.45dB$

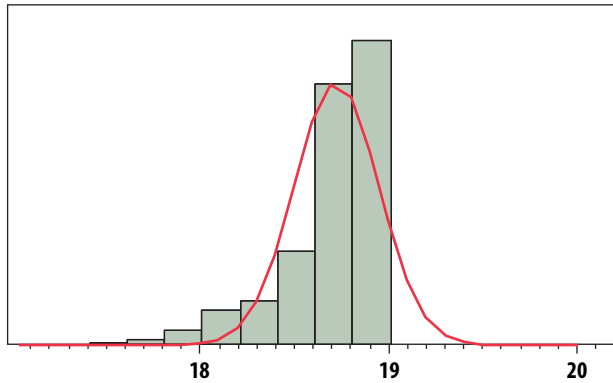

Figure 4.  $Gain$  @ 900MHz,  $V_{dd} = 5V$ ,  $LSL=17dB$ ,  $Nominal=18.7dB$ ,  $USL=20dB$

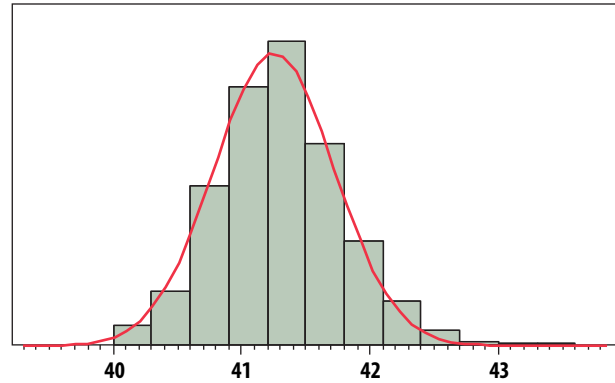

Figure 5.  $OIP3$  @ 900MHz,  $V_{dd} = 5V$ ,  $LSL=38.2$ ,  $Nominal=41.8dBm$

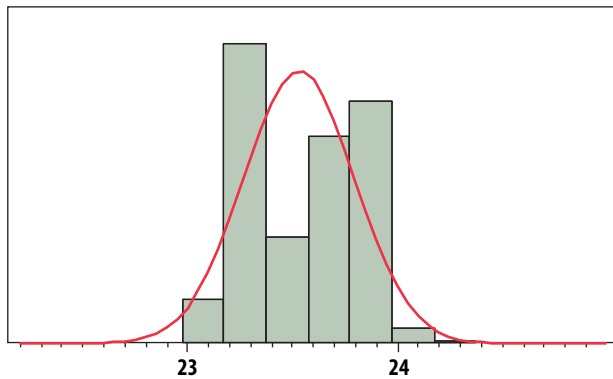

Figure 6.  $P1dB$  @ 900MHz,  $V_{dd} = 5V$ ,  $LSL=21.8dBm$ ,  $Nominal=23.6dBm$

### Notes:

1. Data sample size is 2800 samples taken from 4 different wafers and 2 different lots. Future wafers allocated to this product may have nominal values anywhere between the upper and lower limits.
2. Measurements are made on production test board which represents a trade-off between optimal Gain, NF, OIP3 and OP1dB. Circuit losses have been de-embedded from actual measurements.

# MGA-31289 Application Circuit Data for 1900MHz

$T_A = 25^\circ\text{C}$ ,  $V_d = 5.0\text{V}$ ,  $I_d = 124\text{mA}$

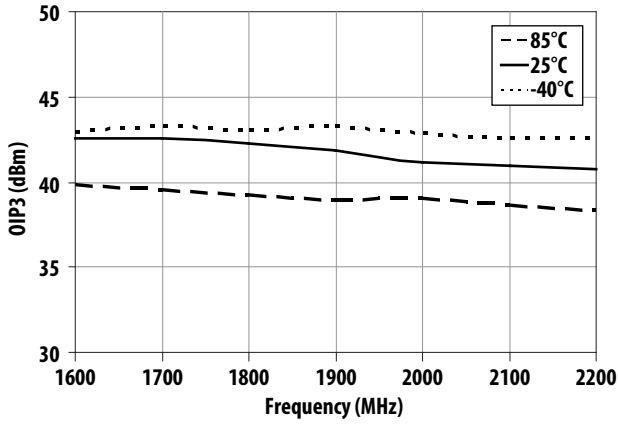

Figure 7. OIP3 vs Frequency and Temperature

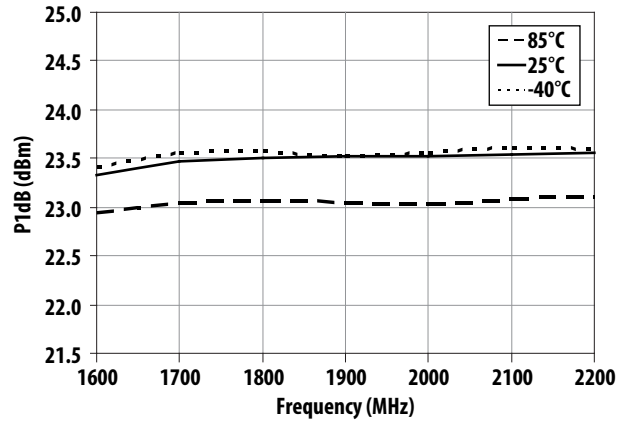

Figure 8. P1dB vs Frequency and Temperature

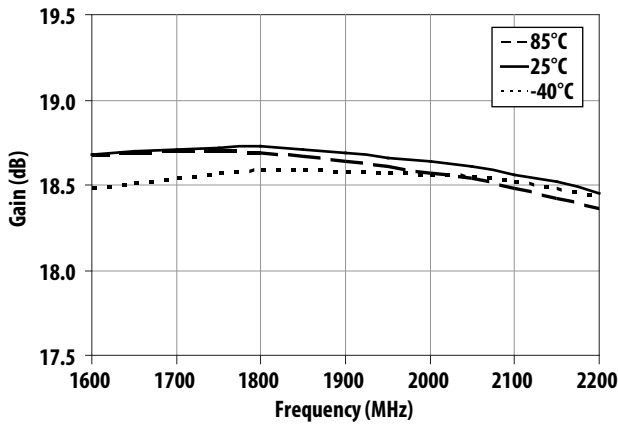

Figure 9. Gain vs Frequency and Temperature

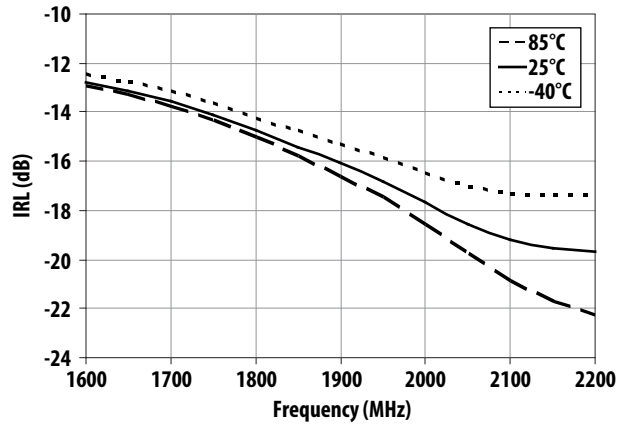

Figure 10. IRL vs Frequency and Temperature

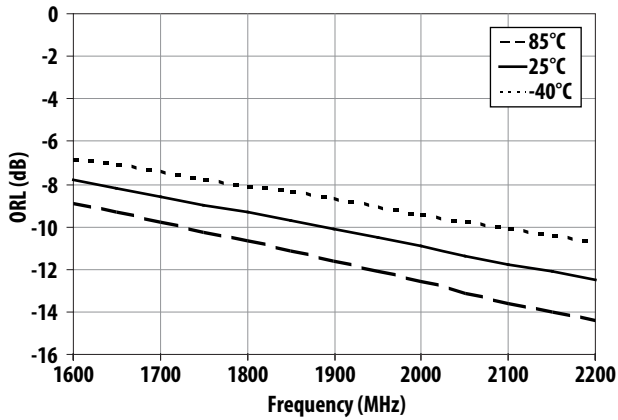

Figure 11. ORL vs Frequency and Temperature

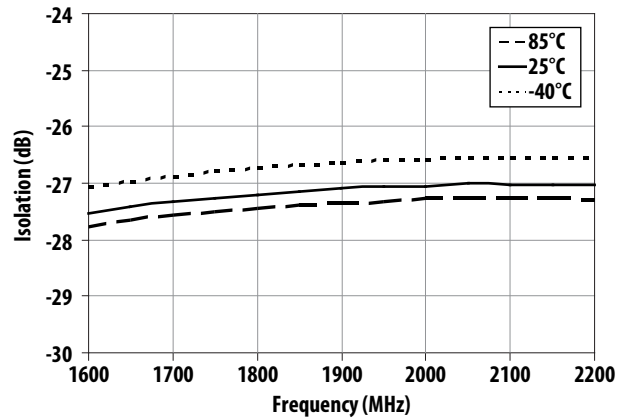

Figure 12. Isolation vs Frequency and Temperature

**MGA-31289 Application Circuit Data for 1900MHz (continue)**

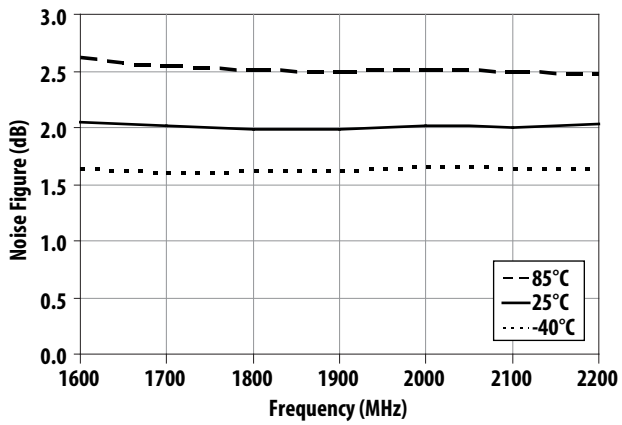

Figure 13. Noise Figure vs Frequency and Temperature

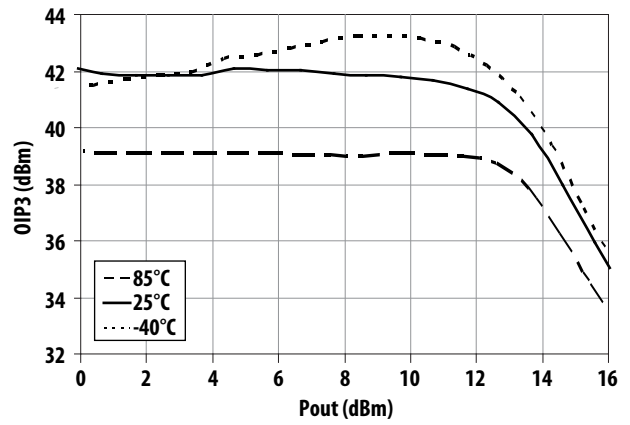

Figure 14. OIP3 vs Output Power and Temperature

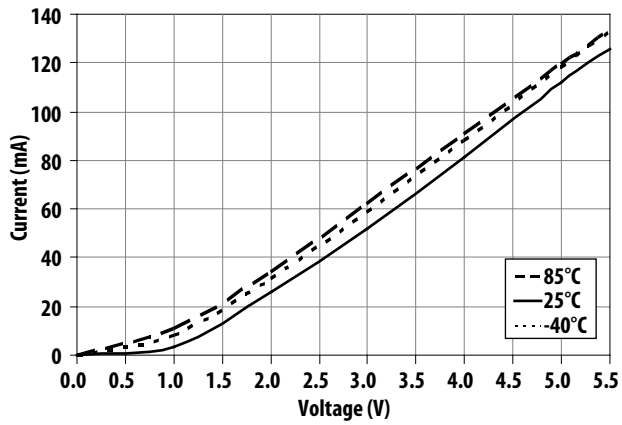

Figure 15. Current vs Voltage and Temperature

# MGA-31289 Application Circuit Data for 2500MHz

$T_A = 25^\circ\text{C}$ ,  $V_d = 5.0\text{V}$ ,  $I_d = 124\text{mA}$

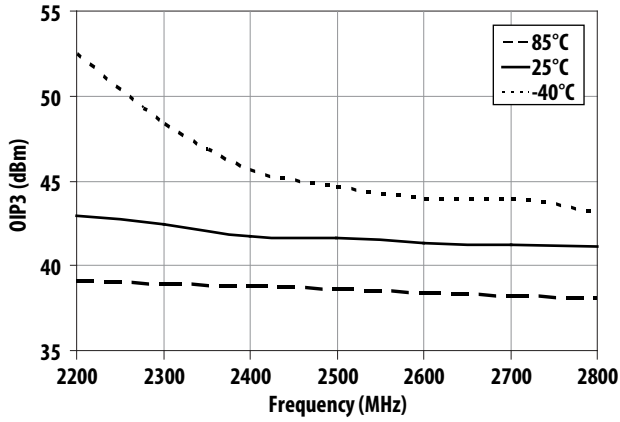

Figure 16. OIP3 vs Frequency and Temperature

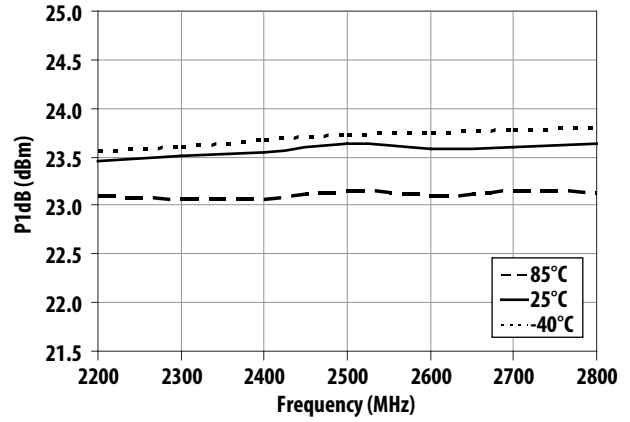

Figure 17. P1dB vs Frequency and Temperature

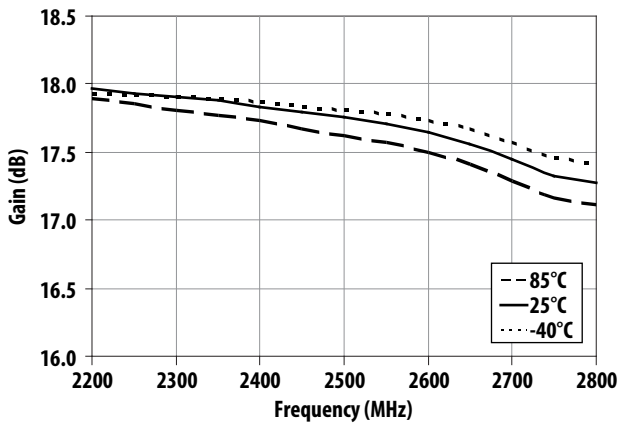

Figure 18. Gain vs Frequency and Temperature

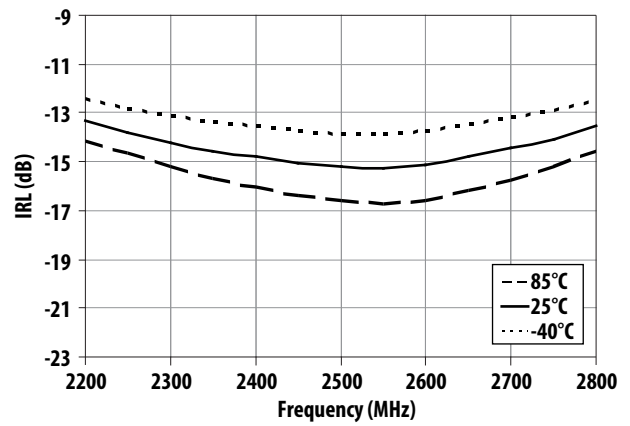

Figure 19. IRL vs Frequency and Temperature

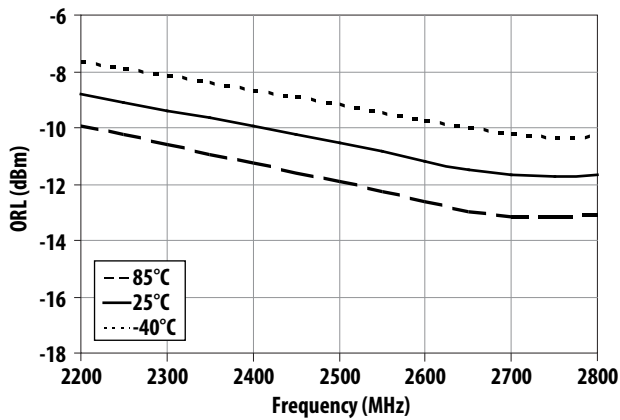

Figure 20. ORL vs Frequency and Temperature

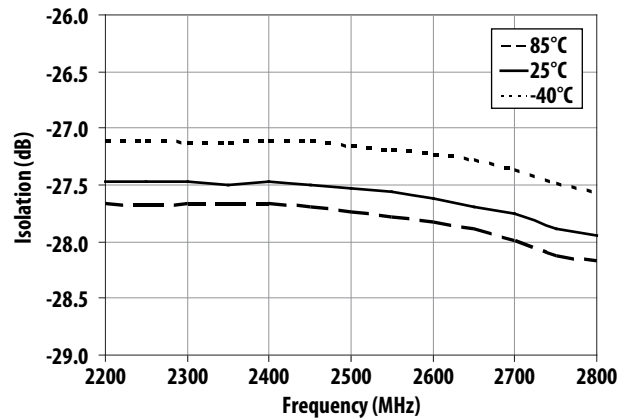

Figure 21. Isolation vs Frequency and Temperature

**MGA-31289 Application Circuit Data for 2500MHz (continue)**

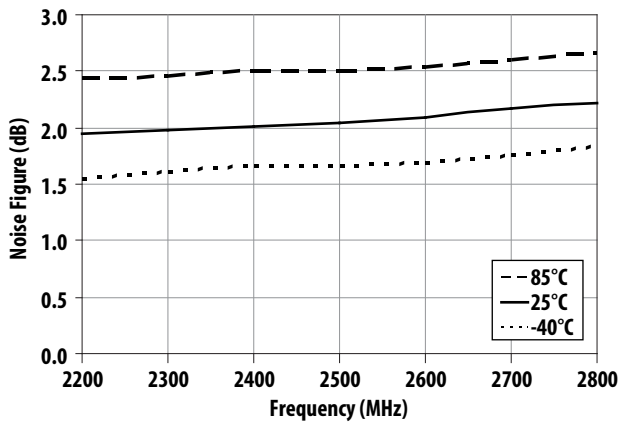

Figure 22. Noise Figure vs Frequency and Temperature

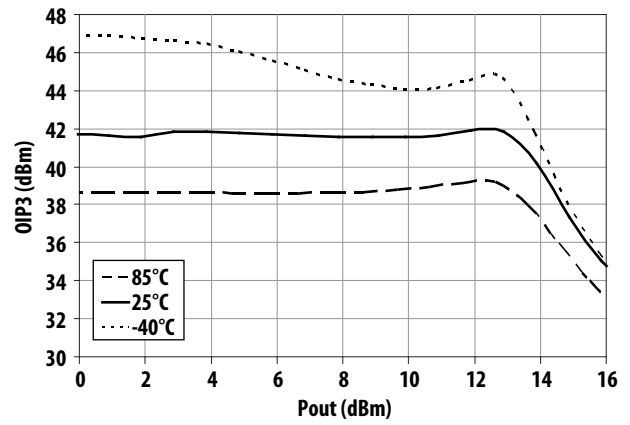

Figure 23. OIP3 vs Output Power and Temperature

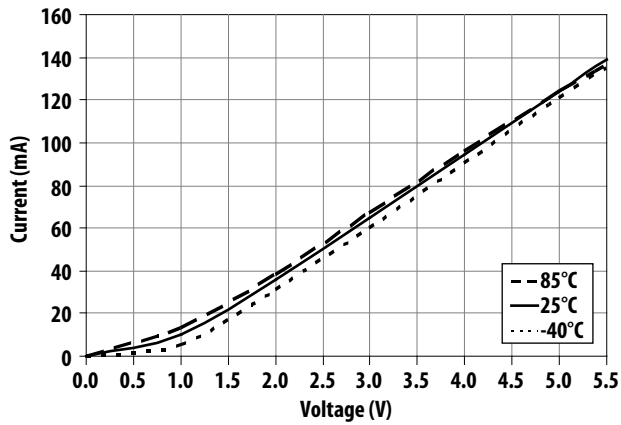

Figure 24. Current vs Voltage and Temperature

## Application Circuit Description and Layout

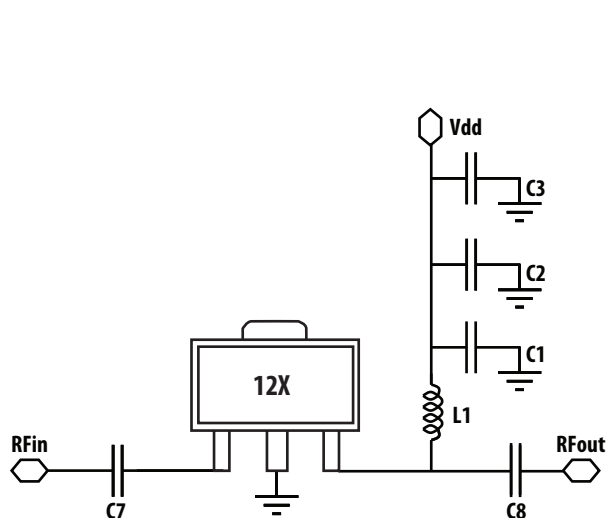

Figure 25. Circuit diagram

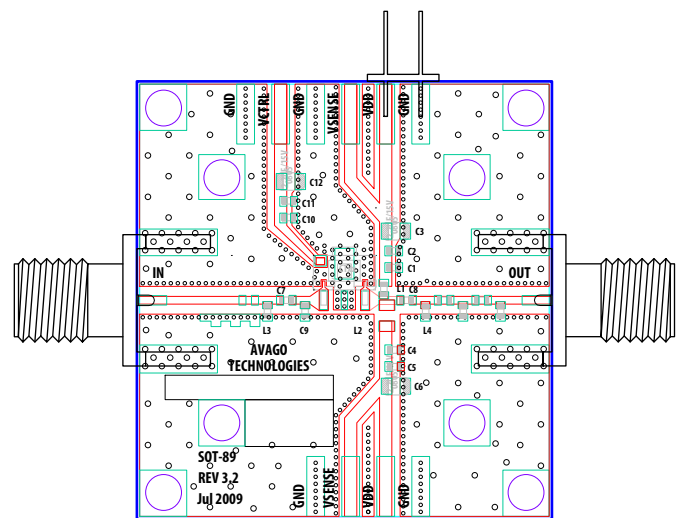

Figure 26. Demoboard

### Bill of Materials

Circuit Symbol	Size	Description			
		For 1.9GHz <sup>(1)</sup>		For 2.5GHz <sup>(2)</sup>	
		Value	Manufacturer	Value	Manufacturer
C1	0402	3.9pF	Murata	2.7pF	Murata
C2	0402	0.1μF	Murata	0.1μF	Murata
C3	0603	2.2μF	Murata	2.2μF	Murata
C7	0402	10pF	Murata	100pF	Murata
C8	0402	100pF	Murata	100pF	Murata
L1	0402	5.6nH	Murata	3.3nH	Toko

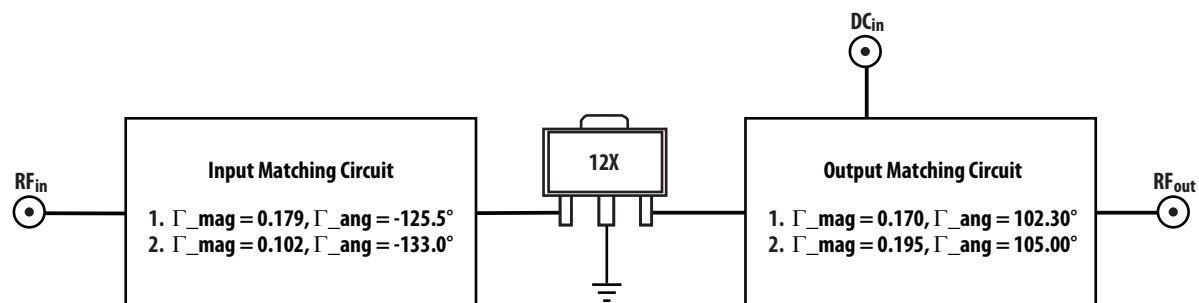

Figure 27. Input and output tuned Gamma location for 1900MHz<sup>(1)</sup>, 2500MHz<sup>(2)</sup>

MGA-31289 is an input and output prematched driver amplifier. To bias MGA-31289, a +5V supply (Vdd) is connected to the output pin through a RF choke, L1 (which isolates the inband signal from the DC supply). The bypass capacitors (C1, C2 and C3) help to eliminate out of band low frequency signals from the power supply. Blocking capacitors are required for its input (C7) and output (C8), to isolate the supply voltage from preceding and succeeding circuits. C7 also plays a part in input tuning to improve input return loss while L1 and C8 help in output matching. The recommended output tuning is for achieving best OIP3, while meeting typical specifications for other parameters.



## MGA-31289 Typical Scatter Parameters (1)

$T_A = 25^\circ\text{C}$ ,  $V_d = 5.0\text{V}$ ,  $I_d = 124\text{mA}$ ,  $Z_o = 50\Omega$

Freq GHz	S11	S11	S11	S21	S21	S21	S12	S12	S12	S22	S22	S22	K
	Mag.	Ang.	dB	Mag.	Ang.	dB	Mag.	Ang.	dB	Mag.	Ang.	dB	
0.05	0.90	176.00	-0.96	0.10	-138.44	-20.42	0.00	50.02	-66.94	0.83	177.77	-1.58	706.23
0.10	0.89	172.37	-0.97	0.14	-111.67	-17.33	0.00	116.16	-66.79	0.83	173.32	-1.63	502.64
0.20	0.89	164.77	-0.98	0.30	-84.22	-10.47	0.00	118.26	-56.73	0.82	165.72	-1.68	73.92
0.30	0.89	156.86	-0.98	0.58	-76.20	-4.71	0.00	117.54	-52.01	0.82	158.16	-1.75	22.90
0.40	0.89	148.34	-1.04	1.00	-77.36	0.01	0.00	121.16	-47.32	0.80	150.04	-1.92	9.07
0.50	0.87	139.08	-1.20	1.58	-83.18	3.96	0.01	118.98	-43.55	0.78	141.53	-2.21	4.87
0.60	0.85	128.94	-1.45	2.33	-91.97	7.36	0.01	114.39	-40.18	0.74	132.45	-2.63	3.15
0.70	0.81	117.74	-1.85	3.29	-103.03	10.35	0.01	107.35	-37.13	0.69	122.65	-3.23	2.32
0.80	0.74	105.37	-2.56	4.41	-116.67	12.88	0.02	97.31	-34.43	0.62	112.37	-4.17	1.93
0.90	0.66	91.69	-3.57	5.70	-131.64	15.12	0.02	86.32	-32.10	0.53	101.71	-5.46	1.67
1.00	0.55	75.92	-5.20	7.02	-148.43	16.92	0.03	72.97	-30.15	0.43	91.88	-7.26	1.52
1.10	0.42	60.05	-7.61	8.16	-166.16	18.24	0.04	58.73	-28.65	0.33	85.01	-9.71	1.42
1.20	0.28	46.84	-11.11	9.02	176.38	19.11	0.04	44.57	-27.60	0.23	85.96	-12.83	1.35
1.30	0.15	40.60	-16.49	9.52	159.78	19.57	0.04	30.96	-26.99	0.17	99.47	-15.48	1.31
1.40	0.06	68.58	-24.49	9.73	144.35	19.76	0.05	18.40	-26.63	0.16	118.54	-15.78	1.29
1.50	0.08	130.90	-21.79	9.72	130.34	19.75	0.05	7.30	-26.47	0.19	128.54	-14.54	1.28
1.60	0.14	136.84	-17.07	9.60	117.63	19.65	0.05	-2.92	-26.42	0.22	130.13	-13.30	1.27
1.70	0.19	131.02	-14.59	9.44	106.04	19.50	0.05	-11.91	-26.42	0.24	128.12	-12.45	1.28
1.80	0.22	122.69	-13.16	9.25	95.27	19.32	0.05	-20.35	-26.49	0.25	124.62	-11.92	1.29
1.90	0.24	113.45	-12.34	9.07	85.05	19.15	0.05	-28.34	-26.53	0.26	120.23	-11.62	1.30
2.00	0.25	103.97	-11.91	8.90	75.52	18.99	0.05	-35.86	-26.57	0.26	116.00	-11.54	1.32
2.10	0.26	94.33	-11.80	8.74	66.20	18.83	0.05	-43.36	-26.62	0.26	111.82	-11.61	1.34
2.20	0.25	84.30	-11.91	8.62	57.25	18.71	0.05	-50.50	-26.67	0.26	108.07	-11.80	1.36
2.30	0.24	73.82	-12.28	8.50	48.53	18.59	0.05	-57.61	-26.70	0.25	104.90	-12.13	1.38
2.40	0.23	62.53	-12.90	8.39	39.82	18.48	0.05	-64.62	-26.71	0.24	102.10	-12.55	1.40
2.50	0.21	49.87	-13.76	8.31	31.19	18.40	0.05	-71.78	-26.79	0.22	100.25	-13.07	1.43
3.00	0.15	-74.29	-16.40	7.88	-12.75	17.93	0.04	-110.43	-27.21	0.16	111.26	-15.72	1.58
3.50	0.43	-153.06	-7.29	6.93	-58.47	16.82	0.04	-153.19	-28.67	0.20	122.05	-14.18	1.74
4.00	0.67	169.43	-3.45	5.60	-102.14	14.96	0.03	165.03	-31.05	0.14	104.95	-16.88	1.87
5.00	0.86	114.66	-1.33	3.19	172.85	10.08	0.02	88.83	-35.38	0.27	-135.43	-11.34	2.22
6.00	0.89	50.49	-0.99	1.38	97.47	2.80	0.01	29.19	-36.53	0.38	149.37	-8.50	4.15
7.00	0.95	2.17	-0.47	0.54	46.58	-5.35	0.01	-15.36	-37.36	0.39	94.75	-8.16	5.84
8.00	0.98	-14.05	-0.16	0.27	8.81	-11.26	0.01	-43.35	-37.75	0.47	66.73	-6.62	4.09
9.00	0.96	-31.89	-0.32	0.16	-32.27	-15.96	0.01	-72.38	-37.87	0.56	37.77	-5.04	12.09
10.00	0.94	-70.89	-0.58	0.08	-80.93	-21.60	0.01	-108.98	-39.92	0.62	-0.96	-4.08	45.84
11.00	0.95	-102.69	-0.40	0.03	-121.56	-29.74	0.00	-141.20	-46.39	0.72	-40.39	-2.83	136.26
12.00	0.97	-115.91	-0.25	0.01	-144.08	-39.18	0.00	-147.56	-62.59	0.81	-63.12	-1.87	1194.5
13.00	0.97	-125.32	-0.27	0.00	-147.91	-51.96	0.00	-2.63	-53.49	0.83	-81.81	-1.65	1771.7
14.00	0.96	-145.29	-0.38	0.00	-44.69	-49.13	0.01	-31.64	-45.86	0.82	-104.80	-1.69	764.55
15.00	0.96	-170.76	-0.31	0.01	-63.24	-44.11	0.01	-59.47	-43.55	0.83	-131.82	-1.59	259.48
16.00	0.97	175.48	-0.22	0.00	-87.63	-46.38	0.00	-84.21	-46.39	0.85	-151.51	-1.37	292.24
17.00	0.96	167.92	-0.31	0.00	-60.01	-52.59	0.00	-55.23	-52.88	0.87	-162.58	-1.24	1617.9
18.00	0.95	158.60	-0.45	0.01	-20.69	-45.67	0.01	-18.78	-45.62	0.87	-169.97	-1.24	445.59
19.00	0.93	140.29	-0.65	0.01	-16.45	-41.90	0.01	-15.28	-42.15	0.84	179.75	-1.52	327.89
20.00	0.95	118.62	-0.48	0.01	-17.88	-39.82	0.01	-16.56	-39.80	0.82	161.97	-1.73	163.82

### MGA-31289 K-Factor (1)

$T_A = 25^\circ\text{C}$ ,  $V_d = 5.0\text{V}$ ,  $I_d = 124\text{mA}$ ,  $Z_o = 50\Omega$

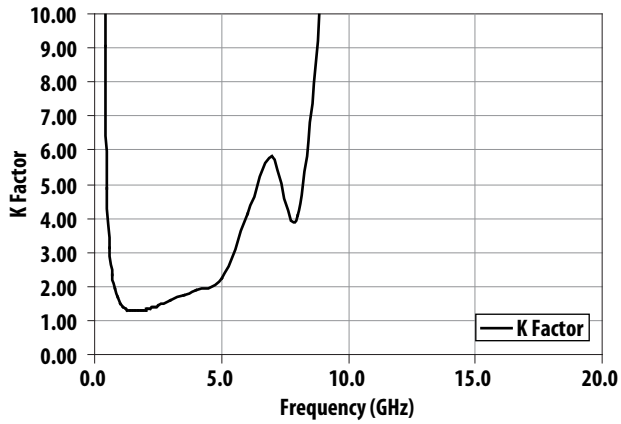

### MGA-31289 Typical Noise Parameters (1)

$T_A = 25^\circ\text{C}$ ,  $V_d = 5.0\text{V}$ ,  $I_d = 124\text{mA}$ ,  $Z_o = 50\Omega$

Freq (GHz)	$F_{min}$ (dB)	$\Gamma_{opt}$ Mag	$\Gamma_{opt}$ Ang	$R_n/Z_o$	Ga (dB)
0.5	7.27	0.82	-142	1.49	13.48
0.8	3.35	0.64	-119.4	0.59	17.91
0.9	3.24	0.537	-113.3	0.52	18.58
1	2.98	0.497	-103.1	0.48	19.17
1.5	2.2	0.225	-83.1	0.29	19.90
2	2.08	0.077	-92.9	0.23	19.30
2.5	1.93	0.096	158.8	0.2	18.48
3	2.05	0.31	159.2	0.13	17.66
3.5	2.45	0.385	174.3	0.13	17.43
4	3.13	0.557	-159	0.14	17.11
4.5	4.20	0.692	-135.5	0.73	16.78
5	4.63	0.787	-113.2	1.53	15.84
5.5	4.78	0.91	-88	4.08	13.86
6	6.11	0.87	-65.7	9.48	10.37

Note:

1. Measurements are made on 10mils Rogers RO4350 TRL Board.

## Part Number Ordering Information

Part Number	No. of Devices	Container
MGA-31289-BLKG	100	7" Tape/Reel
MGA-31289-TR1G	3000	13" Tape/Reel

## SOT89 Package Dimensions

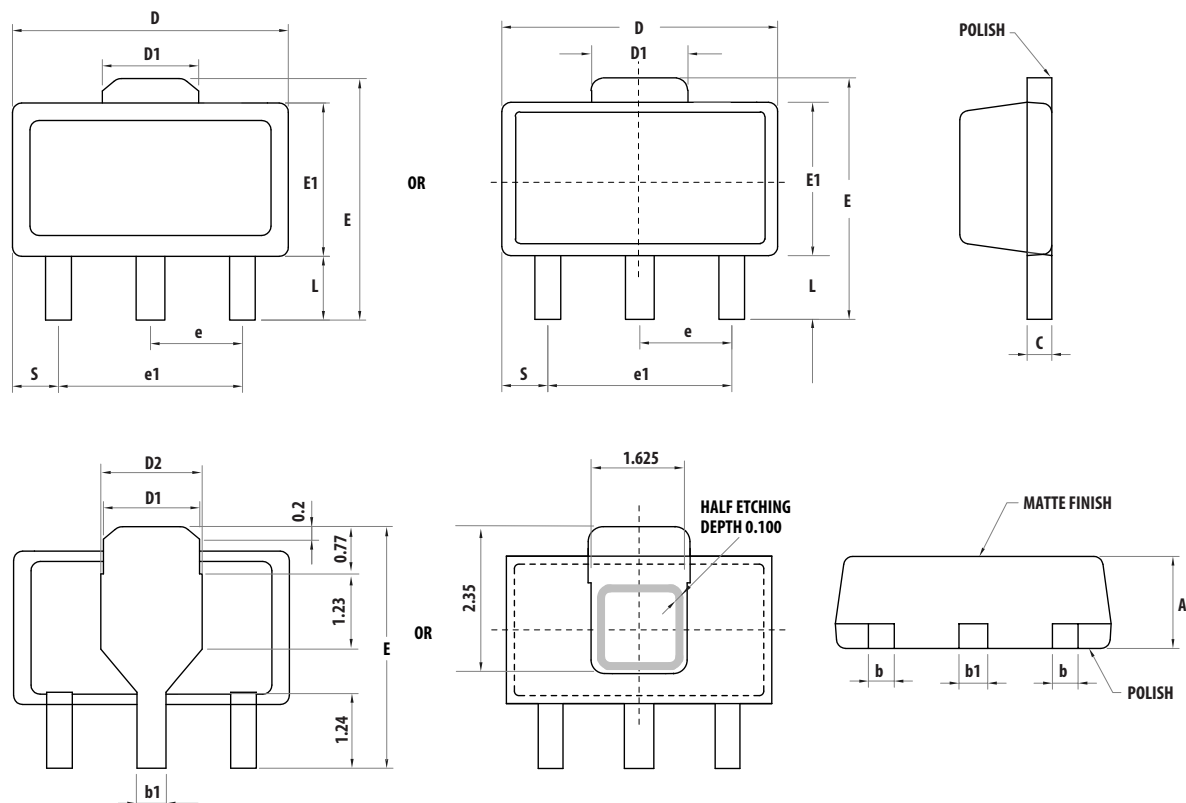

Symbols	Dimensions in mm			Dimensions in inches		
	Minimum	Nominal	Maximum	Minimum	Nominal	Maximum
A	1.40	1.50	1.60	0.055	0.059	0.063
L	0.89	1.04	1.20	0.0350	0.041	0.047
b	0.36	0.42	0.48	0.014	0.016	0.018
b1	0.41	0.47	0.53	0.016	0.018	0.030
C	0.38	0.40	0.43	0.014	0.015	0.017
D	4.40	4.50	4.60	0.173	0.177	0.181
D1	1.40	1.60	1.75	0.055	0.062	0.069
D2	1.45	1.65	1.80	0.055	0.062	0.069
E	3.94	-	4.25	0.155	-	0.167
E1	2.40	2.50	2.60	0.094	0.098	0.102
e1	2.90	3.00	3.10	0.114	0.118	0.122
S	0.65	0.75	0.85	0.026	0.030	0.034
e	1.40	1.50	1.60	0.054	0.059	0.063

## Device Orientation

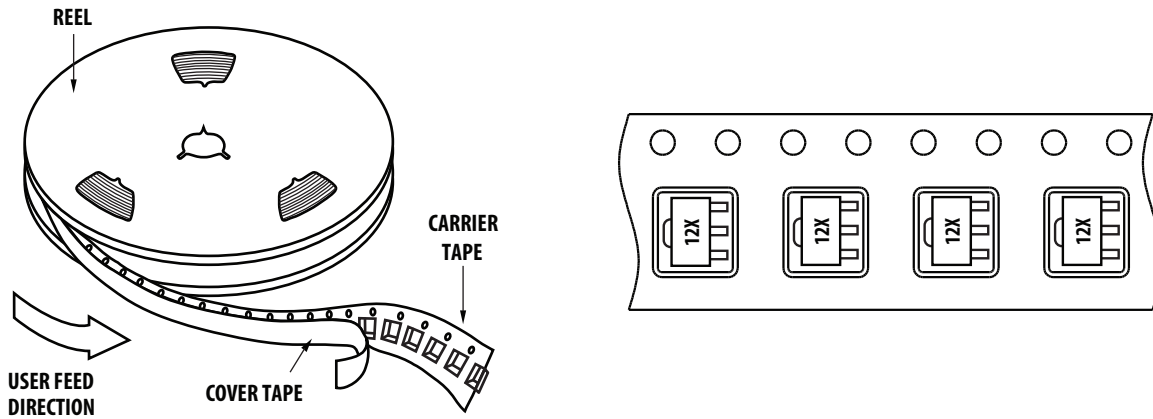

## Tape Dimensions

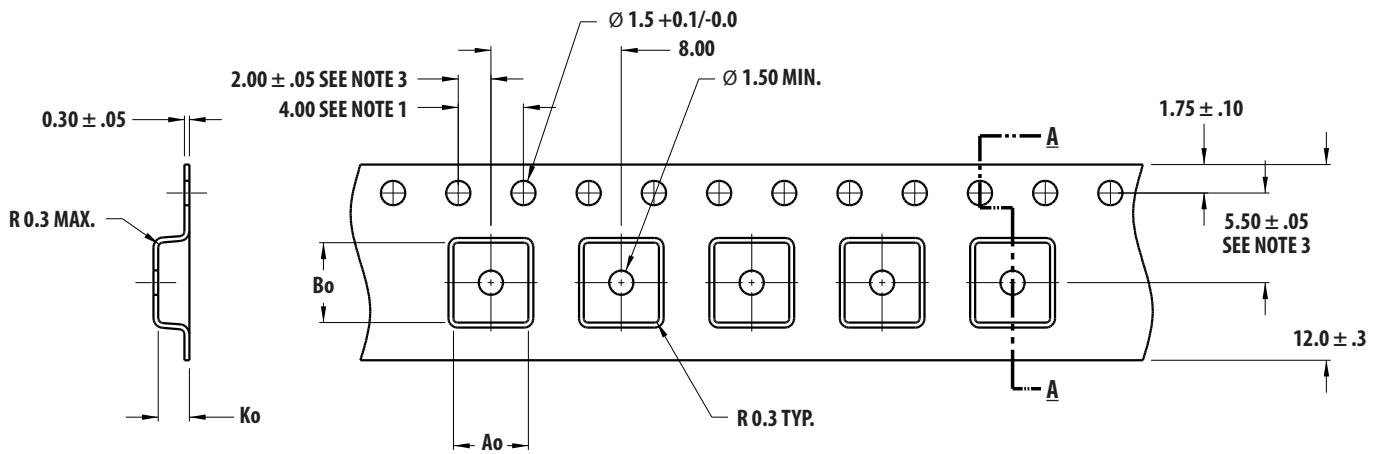

### SECTION A - A

Ao = 4.60  
Bo = 4.90  
Ko = 1.90

### DIMENSIONS IN MM

#### NOTES:

1. 10 SPROCKET HOLE PITCH CUMULATIVE TOLERANCE  $\pm 0.2$
2. CAMBER IN COMPLIANCE WITH EIA 481
3. POCKET POSITION RELATIVE TO SPROCKET HOLE MEASURED AS TRUE POSITION OF POCKET, NOT POCKET HOLE

# Reel Dimensions – 13" Reel

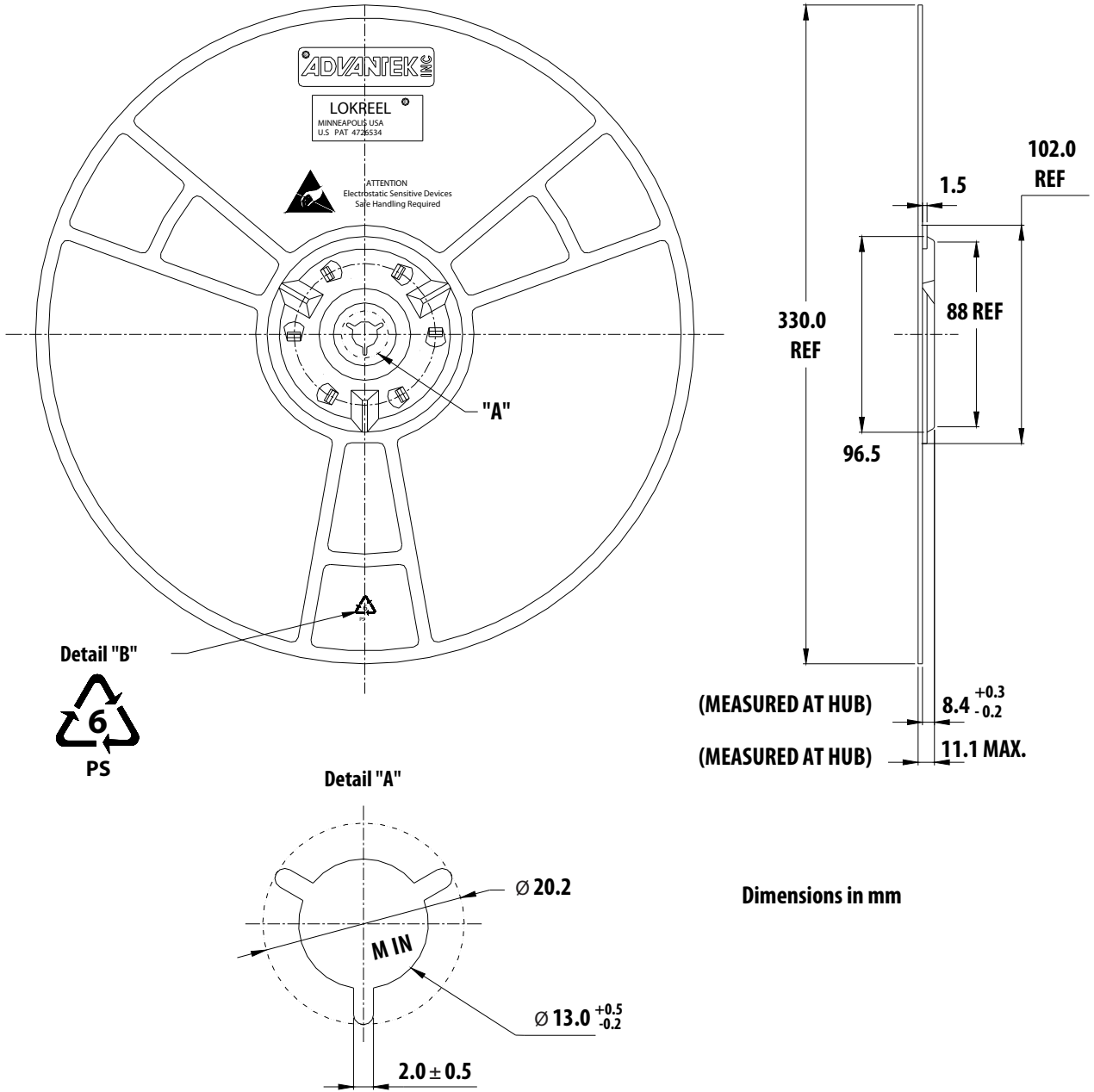

For product information and a complete list of distributors, please go to our web site: [www.avagotech.com](http://www.avagotech.com)

Avago, Avago Technologies, and the A logo are trademarks of Avago Technologies in the United States and other countries. Data subject to change. Copyright © 2005-2013 Avago Technologies. All rights reserved. AV02-2533EN - November 11, 2013



# Mouser Electronics

Authorized Distributor

Click to View Pricing, Inventory, Delivery & Lifecycle Information:

[Avago Technologies:](#)

[MGA-31289-BLKG](#) [MGA-31289-TR1G](#)