

ATF-551M4

Low Noise Enhancement Mode Pseudomorphic HEMT in a Miniature Leadless Package



Data Sheet

Description

Avago Technologies' ATF-551M4 is a high dynamic range, super low noise, single supply E-pHEMT GaAs FET housed in a thin miniature leadless package.

The combination of small device size, super low noise (under 1 dB Fmin from 2 to 6 GHz), high linearity and low power makes the ATF-551M4 ideal for LNA or hybrid module designs in wireless receiver in the 450 MHz to 10 GHz frequency band.

Applications include Cellular/PCS/ WCDMA handsets and data modem cards, fixed wireless infrastructure in the 2.4, 3.5 GHz and UNII frequency bands, as well as 2.4 GHz 802.11b, 5 GHz 802.11a and HIPERLAN/2 Wireless LAN PC-cards.

Note:

1. Avago's enhancement mode E-pHEMT devices are the first commercially available single-supply GaAs transistors that do not need a negative gate bias voltage for operation. They can help simplify the design and reduce the cost of receivers and transmitters in many applications in the 450 MHz to 10 GHz frequency range.

MiniPak 1.4 mm x 1.2 mm Package

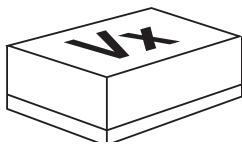

Pin Connections and Package Marking

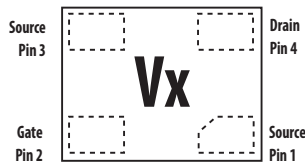

Note:

Top View. Package marking provides orientation, product identification and date code.

"V" = Device Type Code

"x" = Date code character. A different character is assigned for each month and year.

Features

- Very low noise figure and high linearity
- Single Supply Enhancement Mode Technology⁽¹⁾ optimized for 3V operation
- Excellent uniformity in product specifications
- 400 micron gate width
- Thin miniature package 1.4 mm x 1.2 mm x 0.7 mm
- Tape-and-reel packaging option available

Specifications

- 2 GHz; 2.7V, 10 mA (typ.)
- 24.1 dBm output 3rd order intercept
- 14.6 dBm output power at 1 dB gain compression
- 0.5 dB noise figure
- 17.5 dB associated gain

Applications

- Low Noise Amplifier for:
 - Cellular/PCS/WCDMA handsets and modem cards
 - 2.4 GHz, 3.5 GHz and UNII fixed wireless infrastructure
 - 2.4 GHz 802.11b Wireless LAN
 - 5 GHz 802.11a and HIPERLAN Wireless LAN
- General purpose discrete E-pHEMT for other ultra low noise applications

ATF-551M4 Absolute Maximum Ratings^[1]

| Symbol | Parameter | Units | Absolute Maximum |
|----------------|--|-------|------------------|
| V_{DS} | Drain-Source Voltage ^[2] | V | 5 |
| V_{GS} | Gate-Source Voltage ^[2] | V | -5 to +1 |
| V_{GD} | Gate Drain Voltage ^[2] | V | -5 to +1 |
| I_{DS} | Drain Current ^[2] | mA | 100 |
| I_{GS} | Gate Current ^[5] | mA | 1 |
| P_{diss} | Total Power Dissipation ^[3] | mW | 270 |
| $P_{in\ max.}$ | RF Input Power ($V_d=2.7V, I_d=10mA$) | dBm | 10 |
| | ($V_d=0V, I_d=0mA$) | dBm | 10 |
| T_{CH} | Channel Temperature | °C | 150 |
| T_{STG} | Storage Temperature | °C | -65 to 150 |
| θ_{JC} | Thermal Resistance ^[4] | °C/W | 240 |

Notes:

- Operation of this device above any one of these parameters may cause permanent damage.
- Assumes DC quiescent conditions.
- Source lead temperature is 25°C. Derate 4.2 mW/°C for $T_L > 85^\circ\text{C}$.
- Thermal resistance measured using 150°C Liquid Crystal Measurement method.
- Device can safely handle +10 dBm RF Input Power provided I_{GS} is limited to 1 mA. I_{GS} at P_{1dB} drive RF level is bias circuit dependent. See applications section for additional information.

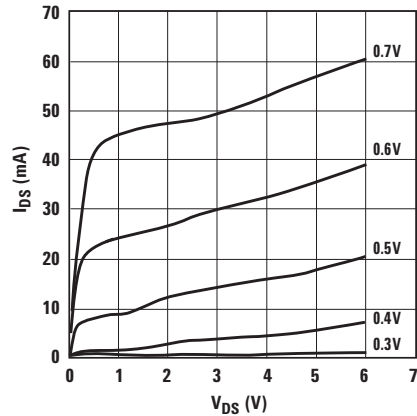

Figure 1. Typical I-V Curves.
($V_{GS} = 0.1\text{ V per step}$)

Product Consistency Distribution Charts^[6]

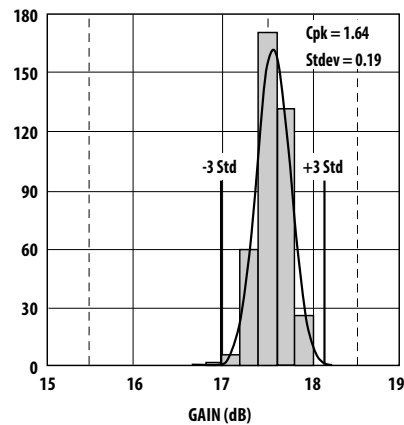

Figure 2. Capability Plot for Gain @ 2.7V,
10 mA. LSL = 15.5, Nominal = 17.5,
USL = 18.5

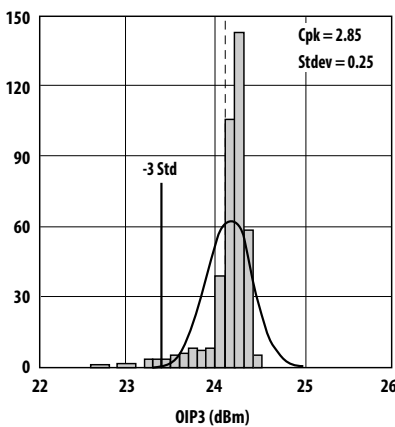

Figure 3. Capability Plot for OIP3 @ 2.7V,
10 mA. LSL = 22.0, Nominal = 24.1

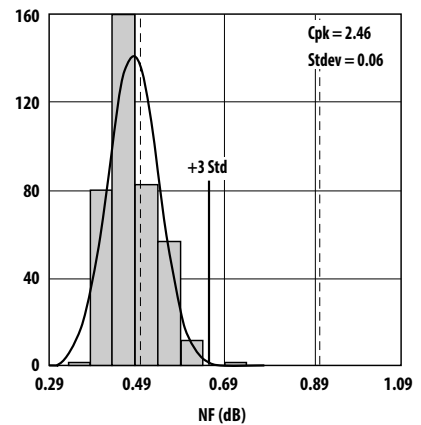

Figure 4. Capability Plot for NF @ 2.7V,
10 mA. Nominal = 0.5, USL = 0.9

Note:

- Distribution data sample size is 398 samples taken from 4 different wafers. Future wafers allocated to this product may have nominal values anywhere between the upper and lower limits. Measurements made on production test board. This circuit represents a trade-off between an optimal noise match and a realizable match based on production test equipment. Circuit losses have been de-embedded from actual measurements.

ATF-551M4 Electrical Specifications

$T_A = 25^\circ\text{C}$, RF parameters measured in a test circuit for a typical device

| Symbol | Parameter and Test Condition | | Units | Min. | Typ. | Max. | |
|--------|---|-----------|---|---------------|------|------|------|
| Vgs | Operational Gate Voltage | | Vds = 2.7V, Ids = 10 mA | V | 0.3 | 0.47 | 0.65 |
| Vth | Threshold Voltage | | Vds = 2.7V, Ids = 2 mA | V | 0.18 | 0.37 | 0.53 |
| Idss | Saturated Drain Current | | Vds = 2.7V, Vgs = 0V | μA | — | 0.1 | 3 |
| Gm | Transconductance | | Vds = 2.7V, gm = $\Delta\text{Idss}/\Delta\text{Vgs}$; $\Delta\text{Vgs} = 0.75 - 0.7 = 0.05\text{V}$ | mmho | 110 | 220 | 285 |
| Igss | Gate Leakage Current | | Vgd = Vgs = -2.7V | μA | — | — | 95 |
| NF | Noise Figure ⁽¹⁾ | f = 2 GHz | Vds = 2.7V, Ids = 10 mA | dB | — | 0.5 | 0.9 |
| | | | Vds = 3V, Ids = 20 mA | dB | — | 0.5 | — |
| Gain | Gain ⁽¹⁾ | f = 2 GHz | Vds = 2.7V, Ids = 10 mA | dB | 15.5 | 17.5 | 18.5 |
| | | | Vds = 3V, Ids = 20 mA | dB | — | 18.0 | — |
| OIP3 | Output 3 rd Order Intercept Point ⁽¹⁾ | f = 2 GHz | Vds = 2.7V, Ids = 10 mA | dBm | 22 | 24.1 | — |
| | | | Vds = 3V, Ids = 20 mA | dBm | — | 30.0 | — |
| P1dB | 1dB Compressed Output Power ⁽¹⁾ | f = 2 GHz | Vds = 2.7V, Ids = 10 mA | dBm | — | 14.6 | — |
| | | | Vds = 3V, Ids = 20 mA | dBm | — | 16.0 | — |

Notes:

- Measurements obtained using production test board described in Figure 5. Typical values were determined from a sample size of 398 parts from 4 wafers.

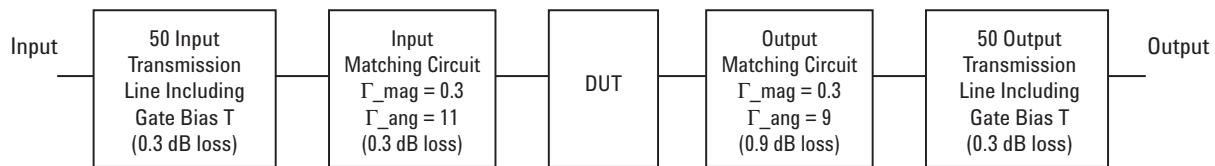

Figure 5. Block diagram of 2 GHz production test board used for Noise Figure, Gain, P1dB, OIP3, and IIP3 measurements. This circuit represents a trade-off between an optimal noise match, maximum OIP3 match and associated impedance matching circuit losses. Circuit losses have been de-embedded from actual measurements.

ATF-551M4 Electrical Specifications (see notes 2 and 3, as indicated)

| Symbol | Parameter and Test Condition | | Units | Min. | Typ. | Max. | |
|--------|---|-------------|-------------------------|------|------|------|---|
| Fmin | Minimum Noise Figure ⁽²⁾ | f = 900 MHz | Vds = 2.7V, Ids = 10 mA | dB | — | 0.27 | — |
| | | f = 2 GHz | Vds = 2.7V, Ids = 10 mA | dB | — | 0.41 | — |
| | | f = 3.9 GHz | Vds = 2.7V, Ids = 10 mA | dB | — | 0.61 | — |
| | | f = 5.8 GHz | Vds = 2.7V, Ids = 10 mA | dB | — | 0.88 | — |
| Ga | Associated Gain ⁽²⁾ | f = 900 MHz | Vds = 2.7V, Ids = 10 mA | dB | — | 21.8 | — |
| | | f = 2 GHz | Vds = 2.7V, Ids = 10 mA | dB | — | 17.9 | — |
| | | f = 3.9 GHz | Vds = 2.7V, Ids = 10 mA | dB | — | 14.2 | — |
| | | f = 5.8 GHz | Vds = 2.7V, Ids = 10 mA | dB | — | 12.0 | — |
| OIP3 | Output 3 rd Order Intercept Point ⁽³⁾ | f = 900 MHz | Vds = 2.7V, Ids = 10 mA | dBm | — | 22.1 | — |
| | | f = 3.9 GHz | Vds = 2.7V, Ids = 10 mA | dBm | — | 24.3 | — |
| | | f = 5.8 GHz | Vds = 2.7V, Ids = 10 mA | dBm | — | 24.5 | — |
| P1dB | 1dB Compressed Output Power ⁽³⁾ | f = 900 MHz | Vds = 2.7V, Ids = 10 mA | dBm | — | 14.3 | — |
| | | f = 3.9 GHz | Vds = 2.7V, Ids = 10 mA | dBm | — | 14.5 | — |
| | | f = 5.8 GHz | Vds = 2.7V, Ids = 10 mA | dBm | — | 14.3 | — |

Notes:

- The Fmin values are based on a set of 16 noise figure measurements made at 16 different impedances using an ATN NP5 test system. From these measurements Fmin is calculated. Refer to the noise parameter measurement section for more information.
- Measurements taken above and below 2 GHz was made using a double stub tuner at the input tuned for low noise and a double stub tuner at the output tuned for maximum OIP3. Circuit losses have been de-embedded from actual measurements.

ATF-551M4 Typical Performance Curves

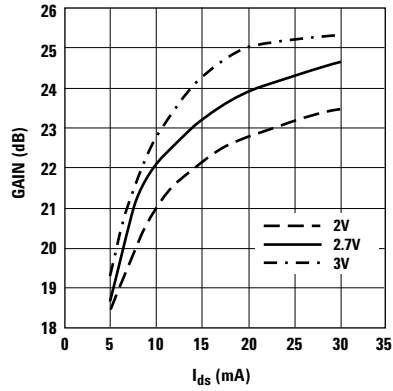

Figure 6. Gain vs. I_{ds} and V_{ds} at 900 MHz^[1].

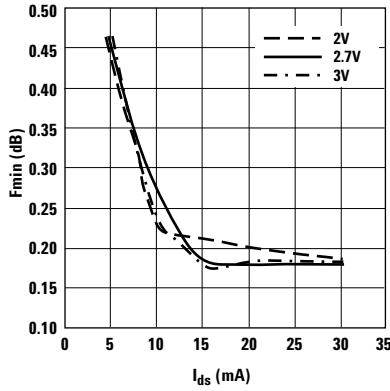

Figure 7. F_{min} vs. I_{ds} and V_{ds} at 900 MHz^[2].

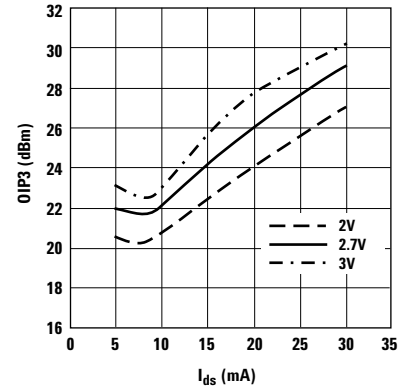

Figure 8. OIP3 vs. I_{ds} and V_{ds} at 900 MHz^[1].

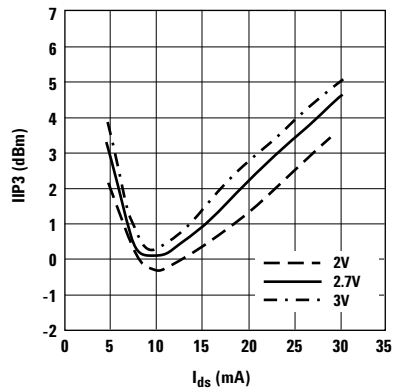

Figure 9. IIP3 vs. I_{ds} and V_{ds} at 900 MHz^[1].

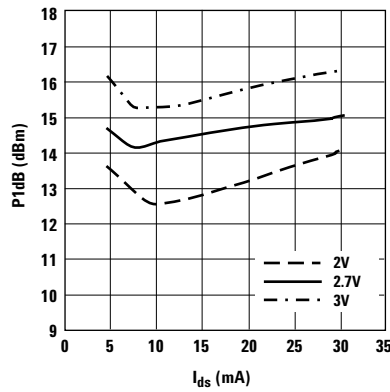

Figure 10. P1dB vs. I_{ds} and V_{ds} at 900 MHz^[1].

Notes:

1. Measurements at 900MHz were made using an ICM fixture with a double stub tuner at the input tuned for low noise and a double stub tuner at the output tuned for maximum OIP3. Circuit losses have been de-embedded from actual measurements.
2. The F_{min} values are based on a set of 16 noise figure measurements made at 16 different impedances using an ATN NP5 test system. From these measurements F_{min} is calculated. Refer to the noise parameter measurement section for more information.

ATF-551M4 Typical Performance Curves, continued

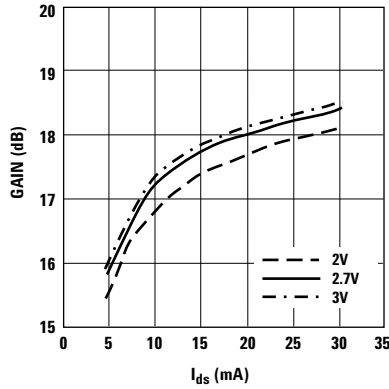

Figure 11. Gain vs. I_{ds} and V_{ds} at 2 GHz^[1].

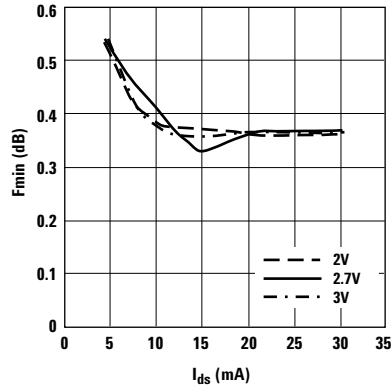

Figure 12. F_{min} vs. I_{ds} and V_{ds} at 2 GHz^[2].

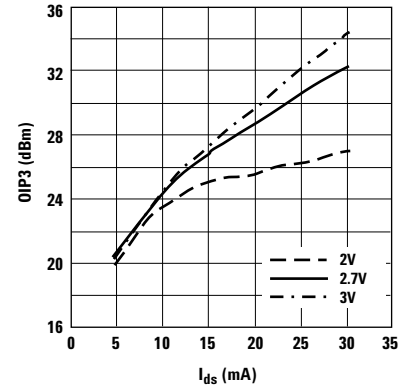

Figure 13. OIP3 vs. I_{ds} and V_{ds} at 2 GHz^[1].

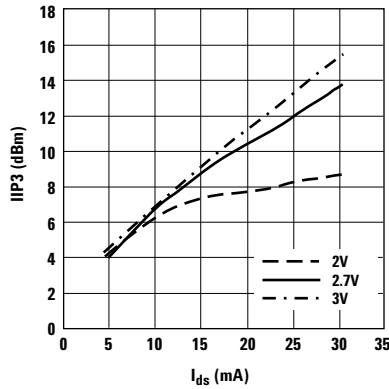

Figure 14. IIP3 vs. I_{ds} and V_{ds} at 2 GHz^[1].

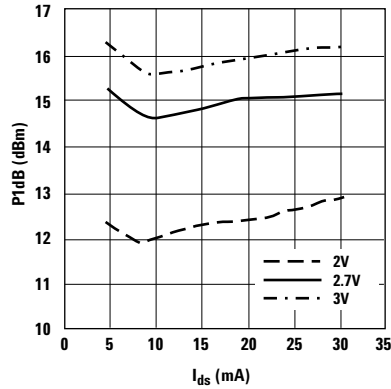

Figure 15. P1dB vs. I_{ds} and V_{ds} at 2 GHz^[1].

Notes:

1. Measurements at 2 GHz with biasing 2.7V, 10 mA were made on a fixed tuned production test board that was tuned for optimal OIP3 match with reasonable noise figure. This circuit represents a trade-off between optimal noise match, maximum OIP3 match and a realizable match based on production test board requirements. Measurements taken other than 2.7V, 10 mA biasing was made using a double stub tuner at the input tuned for low noise and a double stub tuner at the output tuned for maximum OIP3. Circuit losses have been de-embedded from actual measurements.
2. The F_{min} values are based on a set of 16 noise figure measurements made at 16 different impedances using an ATN NP5 test system. From these measurements F_{min} is calculated. Refer to the noise parameter measurement section for more information.

ATF-551M4 Typical Performance Curves, continued

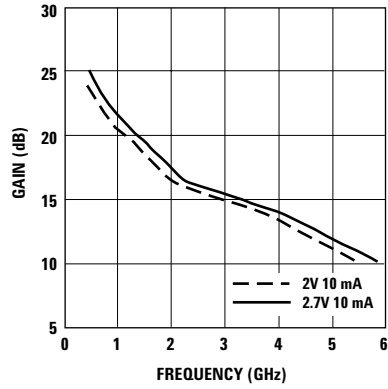

Figure 16. Gain vs. Bias over Frequency^[1].

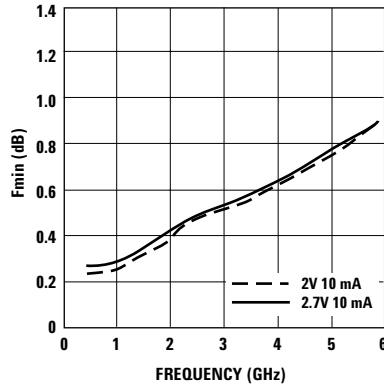

Figure 17. Fmin vs. Bias over Frequency^[2].

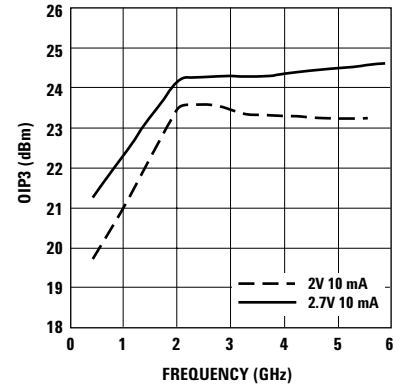

Figure 18. OIP3 vs. Bias over Frequency^[1].

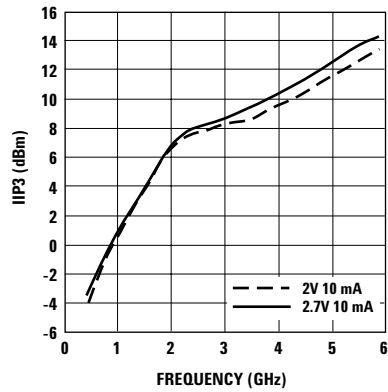

Figure 19. IIP3 vs. Bias over Frequency^[1].

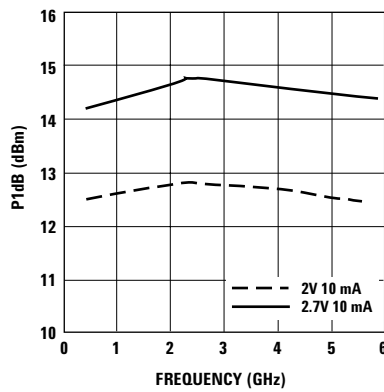

Figure 20. P1dB vs. Bias over Frequency^[1].

Notes:

- Measurements at 2 GHz were made on a fixed tuned production test board that was tuned for optimal OIP3 match with reasonable noise figure at 2.7 V, 10 mA bias. This circuit represents a trade-off between optimal noise match, maximum OIP3 match and a realizable match based on production test board requirements. Measurements taken above and below 2 GHz was made using a double stub tuner at the input tuned for low noise and a double stub tuner at the output tuned for maximum OIP3. Circuit losses have been de-embedded from actual measurements.
- The Fmin values are based on a set of 16 noise figure measurements made at 16 different impedances using an ATN NP5 test system. From these measurements Fmin is calculated. Refer to the noise parameter measurement section for more information.

ATF-551M4 Typical Performance Curves, continued

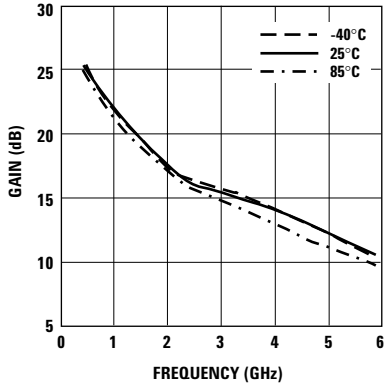

Figure 21. Gain vs. Temperature and Frequency with Bias at 2.7V, 10 mA^[1].

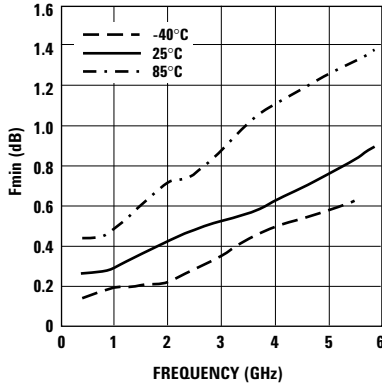

Figure 22. Fmin vs. Temperature and Frequency with Bias at 2.7V, 10 mA^[2].

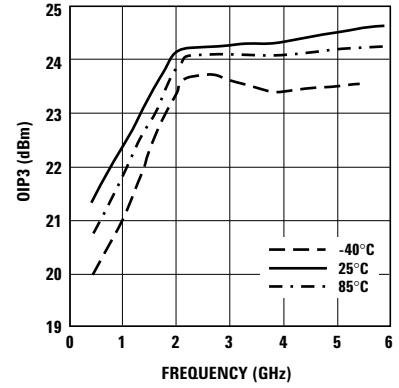

Figure 23. OIP3 vs. Temperature and Frequency with Bias at 2.7V, 10 mA^[1].

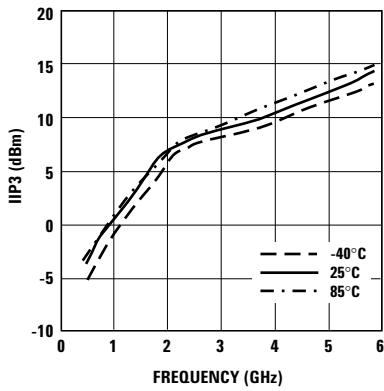

Figure 24. IIP3 vs. Temperature and Frequency with Bias at 2.7V, 10 mA^[1].

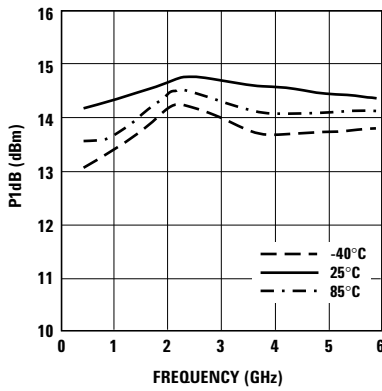

Figure 25. P1dB vs. Temperature and Frequency with Bias at 2.7V, 10 mA^[1].

Notes:

1. Measurements at 2 GHz were made on a fixed tuned production test board that was tuned for optimal OIP3 match with reasonable noise figure at 2.7 V, 10 mA bias. This circuit represents a trade-off between optimal noise match, maximum OIP3 match and a realizable match based on production test board requirements. Measurements taken above and below 2 GHz was made using a double stub tuner at the input tuned for low noise and a double stub tuner at the output tuned for maximum OIP3. Circuit losses have been de-embedded from actual measurements.
2. The Fmin values are based on a set of 16 noise figure measurements made at 16 different impedances using an ATN NP5 test system. From these measurements Fmin is calculated. Refer to the noise parameter measurement section for more information.

ATF-551M4 Typical Scattering Parameters, $V_{DS} = 2V, I_{DS} = 10\text{ mA}$

| Freq. GHz | S_{11} | | | S_{21} | | S_{12} | | S_{22} | | MSG/MAG dB |
|--------------|----------|--------|-------|----------|-------|----------|-------|----------|--------|---------------|
| | Mag. | Ang. | dB | Mag. | Ang. | Mag. | Ang. | Mag. | Ang. | |
| 0.1 | 0.995 | -6.0 | 20.41 | 10.479 | 175.9 | 0.007 | 86.3 | 0.803 | -3.3 | 31.75 |
| 0.5 | 0.954 | -29.1 | 19.95 | 9.946 | 158.2 | 0.031 | 71.6 | 0.758 | -15.6 | 25.06 |
| 0.9 | 0.906 | -50.7 | 19.35 | 9.280 | 144.2 | 0.052 | 60.8 | 0.710 | -27.4 | 22.52 |
| 1.0 | 0.896 | -55.7 | 19.18 | 9.103 | 141.0 | 0.056 | 58.3 | 0.692 | -30.2 | 22.11 |
| 1.5 | 0.833 | -79.5 | 18.15 | 8.080 | 125.6 | 0.075 | 46.8 | 0.611 | -42.3 | 20.32 |
| 1.9 | 0.790 | -96.5 | 17.22 | 7.260 | 114.9 | 0.085 | 39.0 | 0.547 | -50.4 | 19.32 |
| 2.0 | 0.781 | -100.4 | 17.00 | 7.078 | 112.5 | 0.087 | 37.3 | 0.532 | -52.3 | 19.10 |
| 2.5 | 0.739 | -118.5 | 15.84 | 6.197 | 101.1 | 0.095 | 29.8 | 0.463 | -60.6 | 18.14 |
| 3.0 | 0.710 | -134.4 | 14.74 | 5.459 | 91.2 | 0.099 | 23.7 | 0.404 | -67.6 | 17.41 |
| 4.0 | 0.683 | -160.0 | 12.75 | 4.341 | 74.5 | 0.104 | 14.8 | 0.318 | -79.6 | 16.21 |
| 5.0 | 0.679 | -179.8 | 11.03 | 3.559 | 60.3 | 0.105 | 8.6 | 0.263 | -91.2 | 15.30 |
| 6.0 | 0.680 | 166.5 | 9.65 | 3.036 | 48.5 | 0.107 | 5.0 | 0.220 | -99.5 | 14.53 |
| 7.0 | 0.681 | 154.0 | 8.43 | 2.638 | 37.2 | 0.107 | 2.1 | 0.199 | -111.0 | 13.92 |
| 8.0 | 0.683 | 143.7 | 7.43 | 2.353 | 26.4 | 0.110 | -0.3 | 0.185 | -123.4 | 13.30 |
| 9.0 | 0.690 | 132.7 | 6.53 | 2.122 | 15.7 | 0.113 | -2.6 | 0.181 | -137.7 | 11.27 |
| 10.0 | 0.687 | 119.7 | 5.72 | 1.932 | 4.5 | 0.117 | -5.4 | 0.185 | -151.1 | 9.97 |
| 11.0 | 0.691 | 106.5 | 4.98 | 1.775 | -6.4 | 0.122 | -8.4 | 0.196 | -163.5 | 9.14 |
| 12.0 | 0.696 | 92.6 | 4.28 | 1.636 | -17.7 | 0.129 | -12.3 | 0.209 | -174.4 | 8.44 |
| 13.0 | 0.713 | 81.8 | 3.53 | 1.501 | -28.6 | 0.135 | -16.2 | 0.206 | 171.4 | 7.80 |
| 14.0 | 0.747 | 67.4 | 2.82 | 1.384 | -40.4 | 0.143 | -21.8 | 0.211 | 151.2 | 7.62 |
| 15.0 | 0.759 | 55.5 | 1.97 | 1.255 | -51.8 | 0.149 | -27.4 | 0.237 | 131.8 | 6.73 |
| 16.0 | 0.808 | 45.4 | 1.00 | 1.122 | -62.4 | 0.153 | -33.3 | 0.269 | 113.3 | 6.90 |
| 17.0 | 0.828 | 37.3 | -0.01 | 0.999 | -72.7 | 0.157 | -39.2 | 0.322 | 95.4 | 6.20 |
| 18.0 | 0.870 | 30.9 | -1.04 | 0.887 | -82.6 | 0.159 | -45.2 | 0.383 | 80.1 | 7.47 |

Typical Noise Parameters, $V_{DS} = 2V, I_{DS} = 10\text{ mA}$

| Freq GHz | F_{min} dB | Γ_{opt} Mag. | Γ_{opt} Ang. | $R_{n/50}$ | G_a dB |
|-------------|-----------------|------------------------|------------------------|------------|-------------|
| 0.5 | 0.24 | 0.62 | -4.3 | 0.14 | 23.50 |
| 0.9 | 0.24 | 0.56 | 8.8 | 0.13 | 21.66 |
| 1.0 | 0.28 | 0.52 | 13.5 | 0.12 | 21.61 |
| 1.9 | 0.45 | 0.47 | 38.6 | 0.11 | 18.04 |
| 2.0 | 0.39 | 0.47 | 42.9 | 0.11 | 17.88 |
| 2.4 | 0.47 | 0.42 | 52.8 | 0.11 | 16.76 |
| 3.0 | 0.55 | 0.35 | 74.0 | 0.09 | 15.66 |
| 3.9 | 0.61 | 0.32 | 105.4 | 0.08 | 14.10 |
| 5.0 | 0.74 | 0.33 | 144.0 | 0.06 | 12.74 |
| 5.8 | 0.89 | 0.36 | 164.3 | 0.05 | 11.83 |
| 6.0 | 0.90 | 0.37 | 166.1 | 0.05 | 11.63 |
| 7.0 | 1.03 | 0.38 | -170.9 | 0.06 | 10.71 |
| 8.0 | 1.13 | 0.44 | -157.2 | 0.07 | 9.99 |
| 9.0 | 1.27 | 0.48 | -142.4 | 0.09 | 9.36 |
| 10.0 | 1.53 | 0.46 | -126.0 | 0.17 | 8.46 |

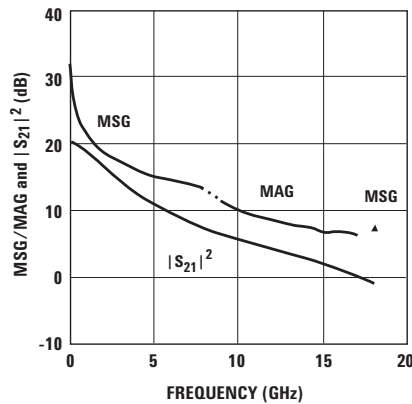

Figure 26. MSG/MAG and $|S_{21}|^2$ vs. Frequency at 2V, 10 mA.

Notes:

1. The F_{min} values are based on a set of 16 noise figure measurements made at 16 different impedances using an ATN NP5 test system. From these measurements F_{min} is calculated. Refer to the noise parameter measurement section for more information.
2. S and noise parameters are measured on a microstrip line made on 0.010 inch thick alumina carrier assembly. The input reference plane is at the end of the gate pad. The output reference plane is at the end of the drain pad.

ATF-551M4 Typical Scattering Parameters, $V_{DS} = 2V, I_{DS} = 15\text{ mA}$

| Freq. GHz | S_{11} | | | S_{21} | | S_{12} | | S_{22} | | MSG/MAG dB |
|--------------|----------|--------|-------|----------|-------|----------|-------|----------|--------|---------------|
| | Mag. | Ang. | dB | Mag. | Ang. | Mag. | Ang. | Mag. | Ang. | |
| 0.1 | 0.995 | -6.6 | 21.93 | 12.489 | 175.5 | 0.006 | 86.2 | 0.765 | -3.7 | 33.18 |
| 0.5 | 0.947 | -31.6 | 21.41 | 11.757 | 156.7 | 0.029 | 70.9 | 0.715 | -17.0 | 26.08 |
| 0.9 | 0.892 | -54.7 | 20.67 | 10.804 | 142.0 | 0.048 | 59.7 | 0.659 | -29.6 | 23.52 |
| 1.0 | 0.880 | -60.1 | 20.46 | 10.547 | 138.6 | 0.052 | 57.1 | 0.641 | -32.5 | 23.07 |
| 1.5 | 0.812 | -84.9 | 19.26 | 9.186 | 123.0 | 0.067 | 46.0 | 0.555 | -45.0 | 21.37 |
| 1.9 | 0.768 | -102.1 | 18.23 | 8.153 | 112.3 | 0.076 | 38.7 | 0.489 | -53.1 | 20.31 |
| 2.0 | 0.758 | -106.1 | 17.98 | 7.923 | 109.9 | 0.077 | 37.2 | 0.474 | -55.0 | 20.12 |
| 2.5 | 0.718 | -124.1 | 16.73 | 6.859 | 98.9 | 0.084 | 30.5 | 0.407 | -63.2 | 19.12 |
| 3.0 | 0.692 | -139.7 | 15.55 | 5.991 | 89.3 | 0.088 | 25.3 | 0.352 | -70.2 | 18.33 |
| 4.0 | 0.671 | -164.5 | 13.47 | 4.716 | 73.3 | 0.092 | 18.0 | 0.272 | -82.3 | 17.10 |
| 5.0 | 0.670 | 176.6 | 11.70 | 3.845 | 59.7 | 0.095 | 13.1 | 0.222 | -94.5 | 16.07 |
| 6.0 | 0.671 | 163.5 | 10.30 | 3.273 | 48.3 | 0.098 | 10.5 | 0.181 | -103.2 | 15.24 |
| 7.0 | 0.674 | 151.5 | 9.06 | 2.838 | 37.4 | 0.101 | 8.2 | 0.164 | -115.4 | 14.49 |
| 8.0 | 0.676 | 141.6 | 8.06 | 2.528 | 27.0 | 0.105 | 6.1 | 0.152 | -128.5 | 12.66 |
| 9.0 | 0.684 | 130.9 | 7.14 | 2.276 | 16.5 | 0.111 | 3.7 | 0.150 | -143.3 | 11.51 |
| 10.0 | 0.682 | 118.0 | 6.33 | 2.072 | 5.6 | 0.117 | 0.6 | 0.156 | -156.9 | 10.35 |
| 11.0 | 0.686 | 105.1 | 5.59 | 1.903 | -5.0 | 0.124 | -3.1 | 0.170 | -169.0 | 9.57 |
| 12.0 | 0.691 | 91.4 | 4.88 | 1.753 | -16.1 | 0.132 | -7.6 | 0.183 | -179.3 | 8.87 |
| 13.0 | 0.708 | 80.9 | 4.13 | 1.609 | -26.9 | 0.140 | -12.3 | 0.181 | 165.9 | 8.27 |
| 14.0 | 0.744 | 66.5 | 3.42 | 1.483 | -38.5 | 0.148 | -18.6 | 0.188 | 145.0 | 8.14 |
| 15.0 | 0.756 | 54.9 | 2.59 | 1.347 | -49.7 | 0.155 | -24.9 | 0.217 | 125.0 | 7.23 |
| 16.0 | 0.805 | 45.0 | 1.59 | 1.201 | -60.2 | 0.158 | -31.2 | 0.253 | 106.8 | 7.38 |
| 17.0 | 0.825 | 37.0 | 0.61 | 1.073 | -70.4 | 0.161 | -37.5 | 0.310 | 89.4 | 6.61 |
| 18.0 | 0.870 | 30.7 | -0.41 | 0.954 | -80.1 | 0.163 | -43.8 | 0.373 | 74.9 | 7.67 |

Typical Noise Parameters, $V_{DS} = 2V, I_{DS} = 15\text{ mA}$

| Freq GHz | F_{min} dB | Γ_{opt} Mag. | Γ_{opt} Ang. | $R_{n/50}$ | G_a dB |
|-------------|-----------------|------------------------|------------------------|------------|-------------|
| 0.5 | 0.21 | 0.61 | -6.1 | 0.12 | 24.12 |
| 0.9 | 0.21 | 0.55 | 7.0 | 0.12 | 22.18 |
| 1.0 | 0.27 | 0.50 | 11.4 | 0.11 | 22.12 |
| 1.9 | 0.42 | 0.46 | 38.1 | 0.10 | 18.61 |
| 2.0 | 0.37 | 0.43 | 42.7 | 0.10 | 18.52 |
| 2.4 | 0.44 | 0.39 | 52.9 | 0.10 | 17.34 |
| 3.0 | 0.52 | 0.32 | 74.4 | 0.08 | 16.21 |
| 3.9 | 0.57 | 0.28 | 108.3 | 0.07 | 14.65 |
| 5.0 | 0.71 | 0.30 | 149.5 | 0.06 | 13.27 |
| 5.8 | 0.85 | 0.35 | 170.0 | 0.05 | 12.38 |
| 6.0 | 0.86 | 0.35 | 171.7 | 0.05 | 12.19 |
| 7.0 | 0.97 | 0.38 | -165.9 | 0.06 | 11.24 |
| 8.0 | 1.08 | 0.43 | -152.1 | 0.07 | 10.49 |
| 9.0 | 1.22 | 0.47 | -138.1 | 0.10 | 9.84 |
| 10.0 | 1.44 | 0.46 | -122.5 | 0.17 | 8.96 |

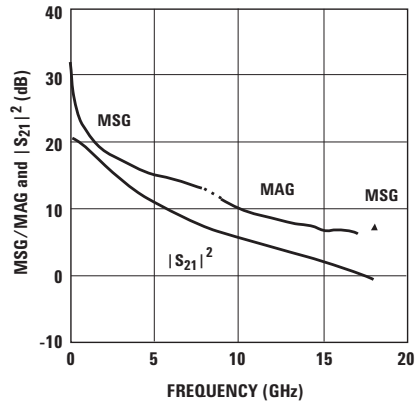

Figure 27. MSG/MAG and $|S_{21}|^2$ vs. Frequency at 2V, 15 mA.

Notes:

1. The F_{min} values are based on a set of 16 noise figure measurements made at 16 different impedances using an ATN NP5 test system. From these measurements F_{min} is calculated. Refer to the noise parameter measurement section for more information.
2. S and noise parameters are measured on a microstrip line made on 0.010 inch thick alumina carrier assembly. The input reference plane is at the end of the gate pad. The output reference plane is at the end of the drain pad.

ATF-551M4 Typical Scattering Parameters, $V_{DS} = 2V, I_{DS} = 20\text{ mA}$

| Freq. GHz | S_{11} | | | S_{21} | | | S_{12} | | S_{22} | | MSG/MAG dB |
|--------------|----------|--------|-------|----------|-------|-------|----------|-------|----------|-------|---------------|
| | Mag. | Ang. | dB | Mag. | Ang. | Mag. | Ang. | Mag. | Ang. | | |
| 0.1 | 0.994 | -6.9 | 22.85 | 13.876 | 175.3 | 0.006 | 85.6 | 0.740 | -3.9 | 33.64 | |
| 0.5 | 0.942 | -33.3 | 22.27 | 12.985 | 155.7 | 0.027 | 70.4 | 0.687 | -17.8 | 26.82 | |
| 0.9 | 0.882 | -57.3 | 21.44 | 11.806 | 140.5 | 0.045 | 59.0 | 0.627 | -30.9 | 24.19 | |
| 1.0 | 0.869 | -62.8 | 21.21 | 11.491 | 137.1 | 0.048 | 56.5 | 0.608 | -33.8 | 23.79 | |
| 1.5 | 0.798 | -88.1 | 19.90 | 9.881 | 121.3 | 0.062 | 45.7 | 0.520 | -46.4 | 22.02 | |
| 1.9 | 0.753 | -105.5 | 18.79 | 8.704 | 110.7 | 0.070 | 38.9 | 0.455 | -54.4 | 20.95 | |
| 2.0 | 0.744 | -109.5 | 18.53 | 8.443 | 108.4 | 0.071 | 37.4 | 0.441 | -56.3 | 20.75 | |
| 2.5 | 0.706 | -127.4 | 17.22 | 7.262 | 97.5 | 0.077 | 31.3 | 0.376 | -64.3 | 19.75 | |
| 3.0 | 0.681 | -142.7 | 16.01 | 6.314 | 88.2 | 0.081 | 26.7 | 0.323 | -71.0 | 18.92 | |
| 4.0 | 0.663 | -167.0 | 13.88 | 4.943 | 72.5 | 0.085 | 20.3 | 0.248 | -82.9 | 17.65 | |
| 5.0 | 0.664 | 174.6 | 12.09 | 4.021 | 59.3 | 0.089 | 16.2 | 0.201 | -95.2 | 16.55 | |
| 6.0 | 0.666 | 161.9 | 10.68 | 3.418 | 48.1 | 0.093 | 14.1 | 0.162 | -103.7 | 15.65 | |
| 7.0 | 0.670 | 150.1 | 9.43 | 2.962 | 37.3 | 0.097 | 12.0 | 0.144 | -116.4 | 14.85 | |
| 8.0 | 0.673 | 140.4 | 8.42 | 2.637 | 27.1 | 0.103 | 10.0 | 0.133 | -130.0 | 12.78 | |
| 9.0 | 0.681 | 129.8 | 7.51 | 2.373 | 16.8 | 0.109 | 7.4 | 0.131 | -145.9 | 11.65 | |
| 10.0 | 0.678 | 117.1 | 6.68 | 2.158 | 6.0 | 0.117 | 3.7 | 0.139 | -160.3 | 10.56 | |
| 11.0 | 0.682 | 104.3 | 5.94 | 1.982 | -4.6 | 0.125 | -0.2 | 0.154 | -172.7 | 9.80 | |
| 12.0 | 0.688 | 90.6 | 5.23 | 1.826 | -15.6 | 0.133 | -5.2 | 0.168 | -176.9 | 9.11 | |
| 13.0 | 0.706 | 80.3 | 4.48 | 1.675 | -26.3 | 0.142 | -10.3 | 0.169 | 161.6 | 8.56 | |
| 14.0 | 0.743 | 65.9 | 3.76 | 1.542 | -38.0 | 0.150 | -17.0 | 0.182 | 139.6 | 8.46 | |
| 15.0 | 0.753 | 54.4 | 2.92 | 1.400 | -48.9 | 0.157 | -23.6 | 0.212 | 121.2 | 7.48 | |
| 16.0 | 0.804 | 44.7 | 1.93 | 1.249 | -59.3 | 0.160 | -30.1 | 0.250 | 103.8 | 7.76 | |
| 17.0 | 0.824 | 36.7 | 0.95 | 1.116 | -69.4 | 0.163 | -36.5 | 0.306 | 87.0 | 6.93 | |
| 18.0 | 0.869 | 30.6 | -0.05 | 0.994 | -78.9 | 0.165 | -43.0 | 0.367 | 73.0 | 7.80 | |

Typical Noise Parameters, $V_{DS} = 2V, I_{DS} = 20\text{ mA}$

| Freq GHz | F_{min} dB | Γ_{opt} Mag. | Γ_{opt} Ang. | $R_{n/50}$ | G_a dB |
|-------------|-----------------|------------------------|------------------------|------------|-------------|
| 0.5 | 0.19 | 0.59 | -7.0 | 0.11 | 23.50 |
| 0.9 | 0.20 | 0.54 | 6.3 | 0.11 | 21.66 |
| 1.0 | 0.25 | 0.48 | 10.1 | 0.10 | 21.61 |
| 1.9 | 0.41 | 0.43 | 38.7 | 0.09 | 18.04 |
| 2.0 | 0.36 | 0.41 | 43.1 | 0.09 | 17.88 |
| 2.4 | 0.43 | 0.37 | 53.4 | 0.09 | 16.76 |
| 3.0 | 0.51 | 0.29 | 76.3 | 0.08 | 15.66 |
| 3.9 | 0.58 | 0.26 | 112.7 | 0.07 | 14.10 |
| 5.0 | 0.70 | 0.29 | 154.0 | 0.05 | 12.74 |
| 5.8 | 0.85 | 0.34 | 173.6 | 0.05 | 11.83 |
| 6.0 | 0.86 | 0.35 | 175.9 | 0.05 | 11.63 |
| 7.0 | 0.94 | 0.37 | -162.3 | 0.06 | 10.71 |
| 8.0 | 1.07 | 0.42 | -148.2 | 0.08 | 9.99 |
| 9.0 | 1.20 | 0.48 | -135.2 | 0.10 | 9.36 |
| 10.0 | 1.43 | 0.46 | -119.5 | 0.17 | 8.46 |

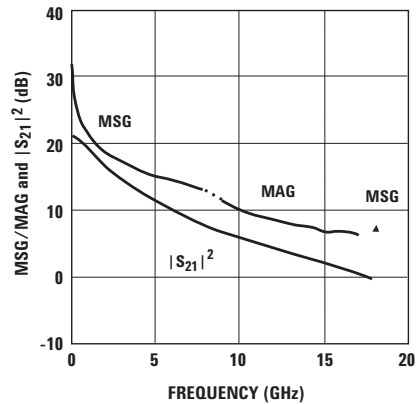

Figure 28. MSG/MAG and $|S_{21}|^2$ vs. Frequency at 2V, 20 mA.

Notes:

1. The F_{min} values are based on a set of 16 noise figure measurements made at 16 different impedances using an ATN NP5 test system. From these measurements F_{min} is calculated. Refer to the noise parameter measurement section for more information.
2. S and noise parameters are measured on a microstrip line made on 0.010 inch thick alumina carrier assembly. The input reference plane is at the end of the gate pad. The output reference plane is at the end of the drain pad.

ATF-551M4 Typical Scattering Parameters, $V_{DS} = 2.7V$, $I_{DS} = 10\text{ mA}$

| Freq. GHz | S_{11} | | | S_{21} | | S_{12} | | S_{22} | | MSG/MAG dB |
|--------------|----------|--------|-------|----------|-------|----------|-------|----------|--------|---------------|
| | Mag. | Ang. | dB | Mag. | Ang. | Mag. | Ang. | Mag. | Ang. | |
| 0.1 | 0.995 | -5.9 | 20.55 | 10.656 | 175.9 | 0.006 | 86.3 | 0.825 | -3.0 | 32.49 |
| 0.5 | 0.955 | -28.7 | 20.11 | 10.129 | 158.4 | 0.028 | 72.0 | 0.782 | -14.0 | 25.58 |
| 0.9 | 0.907 | -50.0 | 19.52 | 9.466 | 144.6 | 0.046 | 61.3 | 0.735 | -24.5 | 23.13 |
| 1.0 | 0.896 | -55.0 | 19.36 | 9.292 | 141.4 | 0.050 | 58.8 | 0.717 | -27.0 | 22.69 |
| 1.5 | 0.833 | -78.6 | 18.34 | 8.265 | 126.1 | 0.067 | 47.6 | 0.639 | -37.6 | 20.91 |
| 1.9 | 0.789 | -95.5 | 17.43 | 7.439 | 115.4 | 0.076 | 40.0 | 0.577 | -44.6 | 19.91 |
| 2.0 | 0.779 | -99.4 | 17.21 | 7.255 | 113.0 | 0.078 | 38.4 | 0.562 | -46.2 | 19.69 |
| 2.5 | 0.737 | -117.4 | 16.07 | 6.361 | 101.7 | 0.085 | 31.0 | 0.495 | -53.1 | 18.74 |
| 3.0 | 0.707 | -133.4 | 14.98 | 5.610 | 91.8 | 0.089 | 25.1 | 0.439 | -58.8 | 18.00 |
| 4.0 | 0.679 | -159.1 | 13.01 | 4.471 | 75.0 | 0.093 | 16.6 | 0.357 | -68.3 | 16.82 |
| 5.0 | 0.674 | -178.9 | 11.30 | 3.673 | 60.8 | 0.094 | 10.9 | 0.303 | -77.6 | 15.92 |
| 6.0 | 0.675 | 167.3 | 9.93 | 3.136 | 49.1 | 0.095 | 8.1 | 0.264 | -83.7 | 15.19 |
| 7.0 | 0.676 | 154.9 | 8.72 | 2.728 | 37.7 | 0.096 | 5.9 | 0.244 | -93.5 | 14.54 |
| 8.0 | 0.679 | 144.5 | 7.73 | 2.435 | 27.0 | 0.099 | 4.3 | 0.230 | -104.1 | 12.94 |
| 9.0 | 0.686 | 133.5 | 6.84 | 2.198 | 16.2 | 0.102 | 2.9 | 0.222 | -116.6 | 11.58 |
| 10.0 | 0.684 | 120.8 | 6.03 | 2.002 | 5.1 | 0.107 | 0.7 | 0.222 | -129.0 | 10.44 |
| 11.0 | 0.688 | 107.5 | 5.30 | 1.841 | -5.9 | 0.113 | -1.7 | 0.230 | -140.8 | 9.69 |
| 12.0 | 0.693 | 93.7 | 4.59 | 1.696 | -17.2 | 0.121 | -5.2 | 0.239 | -151.9 | 9.02 |
| 13.0 | 0.710 | 82.7 | 3.86 | 1.559 | -28.2 | 0.129 | -8.9 | 0.232 | -164.6 | 8.47 |
| 14.0 | 0.743 | 68.6 | 3.19 | 1.443 | -39.8 | 0.139 | -14.3 | 0.222 | -176.6 | 8.42 |
| 15.0 | 0.760 | 56.5 | 2.37 | 1.314 | -51.5 | 0.147 | -20.2 | 0.232 | -155.6 | 7.69 |
| 16.0 | 0.805 | 46.2 | 1.42 | 1.177 | -62.2 | 0.153 | -26.2 | 0.251 | -134.3 | 8.26 |
| 17.0 | 0.830 | 38.1 | 0.43 | 1.051 | -72.8 | 0.158 | -32.5 | 0.293 | -112.0 | 8.07 |
| 18.0 | 0.872 | 31.5 | -0.58 | 0.935 | -83.1 | 0.163 | -39.1 | 0.353 | -92.7 | 7.59 |

Typical Noise Parameters, $V_{DS} = 2.7V$, $I_{DS} = 10\text{ mA}$

| Freq GHz | F_{min} dB | Γ_{opt} Mag. | Γ_{opt} Ang. | $R_{n/50}$ | G_a dB |
|-------------|-----------------|------------------------|------------------------|------------|-------------|
| 0.5 | 0.26 | 0.64 | -4.4 | 0.14 | 23.79 |
| 0.9 | 0.27 | 0.57 | 7.5 | 0.13 | 21.80 |
| 1.0 | 0.30 | 0.54 | 11.1 | 0.13 | 21.60 |
| 1.9 | 0.46 | 0.49 | 36.6 | 0.11 | 18.06 |
| 2.0 | 0.41 | 0.48 | 40.4 | 0.12 | 17.92 |
| 2.4 | 0.47 | 0.44 | 50.3 | 0.11 | 16.79 |
| 3.0 | 0.55 | 0.36 | 69.5 | 0.10 | 15.70 |
| 3.9 | 0.61 | 0.32 | 101.3 | 0.08 | 14.24 |
| 5.0 | 0.74 | 0.32 | 139.5 | 0.06 | 12.86 |
| 5.8 | 0.88 | 0.35 | 161.5 | 0.05 | 12.01 |
| 6.0 | 0.90 | 0.35 | 163.9 | 0.05 | 11.82 |
| 7.0 | 1.00 | 0.37 | -173.6 | 0.06 | 10.93 |
| 8.0 | 1.12 | 0.41 | -158.2 | 0.07 | 10.24 |
| 9.0 | 1.25 | 0.46 | -143.0 | 0.09 | 9.66 |
| 10.0 | 1.46 | 0.46 | -127.2 | 0.15 | 8.85 |

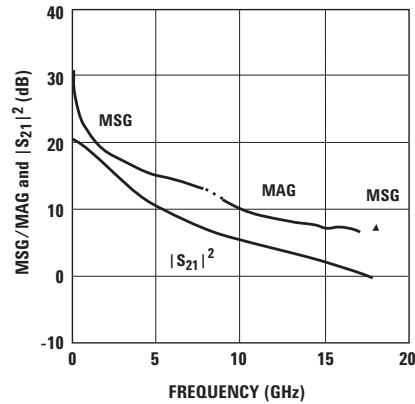

Figure 29. MSG/MAG and $|S_{21}|^2$ vs. Frequency at 2.7V, 10 mA.

Notes:

1. The F_{min} values are based on a set of 16 noise figure measurements made at 16 different impedances using an ATN NP5 test system. From these measurements F_{min} is calculated. Refer to the noise parameter measurement section for more information.
2. S and noise parameters are measured on a microstrip line made on 0.010 inch thick alumina carrier assembly. The input reference plane is at the end of the gate pad. The output reference plane is at the end of the drain pad.

ATF-551M4 Typical Scattering Parameters, $V_{DS} = 2.7V$, $I_{DS} = 15\text{ mA}$

| Freq. GHz | S_{11} | | | S_{21} | | S_{12} | | S_{22} | | MSG/MAG dB |
|--------------|----------|--------|-------|----------|-------|----------|-------|----------|--------|---------------|
| | Mag. | Ang. | dB | Mag. | Ang. | Mag. | Ang. | Mag. | Ang. | |
| 0.1 | 0.995 | -6.5 | 21.98 | 12.559 | 175.6 | 0.006 | 86.4 | 0.793 | -3.2 | 33.21 |
| 0.5 | 0.949 | -31.2 | 21.47 | 11.839 | 156.9 | 0.026 | 71.0 | 0.745 | -15.2 | 26.58 |
| 0.9 | 0.894 | -54.0 | 20.75 | 10.905 | 142.3 | 0.043 | 60.1 | 0.691 | -26.4 | 24.04 |
| 1.0 | 0.882 | -59.4 | 20.55 | 10.650 | 138.9 | 0.047 | 57.5 | 0.673 | -28.9 | 23.55 |
| 1.5 | 0.814 | -84.0 | 19.37 | 9.298 | 123.4 | 0.061 | 46.6 | 0.589 | -39.7 | 21.83 |
| 1.9 | 0.768 | -101.1 | 18.34 | 8.265 | 112.7 | 0.068 | 39.5 | 0.526 | -46.6 | 20.85 |
| 2.0 | 0.758 | -105.1 | 18.10 | 8.034 | 110.3 | 0.070 | 38.0 | 0.511 | -48.1 | 20.60 |
| 2.5 | 0.718 | -123.1 | 16.86 | 6.966 | 99.3 | 0.076 | 31.4 | 0.447 | -54.6 | 19.62 |
| 3.0 | 0.691 | -138.7 | 15.70 | 6.095 | 89.7 | 0.079 | 26.3 | 0.393 | -59.9 | 18.87 |
| 4.0 | 0.668 | -163.5 | 13.64 | 4.806 | 73.6 | 0.083 | 19.4 | 0.318 | -68.8 | 17.63 |
| 5.0 | 0.667 | 177.5 | 11.88 | 3.928 | 59.9 | 0.085 | 15.0 | 0.268 | -77.7 | 16.65 |
| 6.0 | 0.668 | 164.3 | 10.49 | 3.345 | 48.5 | 0.088 | 13.1 | 0.230 | -83.3 | 15.80 |
| 7.0 | 0.671 | 152.2 | 9.26 | 2.904 | 37.5 | 0.091 | 11.4 | 0.212 | -93.0 | 15.04 |
| 8.0 | 0.673 | 142.3 | 8.27 | 2.591 | 27.0 | 0.095 | 10.0 | 0.198 | -103.4 | 12.89 |
| 9.0 | 0.682 | 131.6 | 7.37 | 2.335 | 16.4 | 0.101 | 8.4 | 0.190 | -116.2 | 11.88 |
| 10.0 | 0.677 | 118.5 | 6.56 | 2.128 | 5.4 | 0.107 | 5.6 | 0.190 | -129.6 | 10.70 |
| 11.0 | 0.684 | 105.8 | 5.83 | 1.956 | -5.3 | 0.115 | 2.6 | 0.198 | -142.6 | 10.06 |
| 12.0 | 0.690 | 91.7 | 5.12 | 1.804 | -16.7 | 0.124 | -1.7 | 0.210 | -154.2 | 9.46 |
| 13.0 | 0.707 | 81.2 | 4.38 | 1.656 | -27.5 | 0.133 | -6.1 | 0.205 | -167.8 | 8.93 |
| 14.0 | 0.744 | 66.4 | 3.68 | 1.528 | -39.4 | 0.143 | -12.3 | 0.200 | -172.5 | 9.10 |
| 15.0 | 0.750 | 55.1 | 2.85 | 1.389 | -50.6 | 0.151 | -18.7 | 0.212 | -150.9 | 7.85 |
| 16.0 | 0.806 | 45.2 | 1.88 | 1.242 | -61.2 | 0.156 | -25.1 | 0.236 | 129.7 | 9.01 |
| 17.0 | 0.824 | 37.1 | 0.92 | 1.112 | -71.5 | 0.162 | -31.6 | 0.282 | 107.9 | 8.37 |
| 18.0 | 0.872 | 31.0 | -0.08 | 0.991 | -81.5 | 0.166 | -38.2 | 0.337 | 89.7 | 7.76 |

Typical Noise Parameters, $V_{DS} = 2.7V$, $I_{DS} = 15\text{ mA}$

| Freq GHz | F_{min} dB | Γ_{opt} Mag. | Γ_{opt} Ang. | $R_{n/50}$ | G_a dB |
|-------------|-----------------|------------------------|------------------------|------------|-------------|
| 0.5 | 0.18 | 0.61 | -6.0 | 0.12 | 24.49 |
| 0.9 | 0.18 | 0.56 | 6.8 | 0.12 | 22.38 |
| 1.0 | 0.24 | 0.5 | 10.7 | 0.11 | 22.32 |
| 1.9 | 0.38 | 0.45 | 36.9 | 0.1 | 18.78 |
| 2.0 | 0.33 | 0.43 | 41.9 | 0.1 | 18.65 |
| 2.4 | 0.42 | 0.39 | 50.9 | 0.1 | 17.47 |
| 3.0 | 0.5 | 0.31 | 73.0 | 0.08 | 16.37 |
| 3.9 | 0.55 | 0.28 | 107.0 | 0.07 | 14.83 |
| 5.0 | 0.66 | 0.29 | 146.6 | 0.06 | 13.4 |
| 5.8 | 0.83 | 0.33 | 168.7 | 0.05 | 12.54 |
| 6.0 | 0.84 | 0.34 | 170.7 | 0.05 | 12.36 |
| 7.0 | 0.95 | 0.36 | -166.9 | 0.06 | 11.44 |
| 8.0 | 1.06 | 0.41 | -152.3 | 0.07 | 10.69 |
| 9.0 | 1.18 | 0.46 | -138.1 | 0.1 | 10.12 |
| 10.0 | 1.43 | 0.44 | -122.5 | 0.16 | 9.21 |

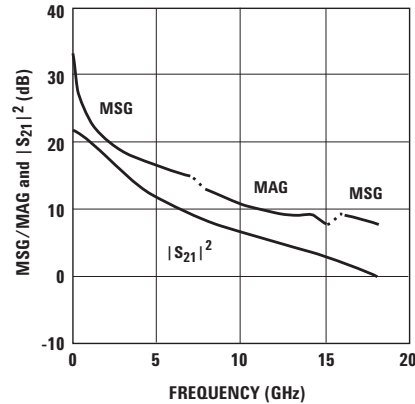

Figure 30. MSG/MAG and $|S_{21}|^2$ vs. Frequency at 2.7V, 15 mA.

Notes:

1. The F_{min} values are based on a set of 16 noise figure measurements made at 16 different impedances using an ATN NP5 test system. From these measurements F_{min} is calculated. Refer to the noise parameter measurement section for more information.
2. S and noise parameters are measured on a microstrip line made on 0.010 inch thick alumina carrier assembly. The input reference plane is at the end of the gate pad. The output reference plane is at the end of the drain pad.

ATF-551M4 Typical Scattering Parameters, $V_{DS} = 2.7V$, $I_{DS} = 20\text{ mA}$

| Freq. GHz | S_{11} | | | S_{21} | | S_{12} | | S_{22} | | MSG/MAG dB |
|--------------|----------|--------|-------|----------|-------|----------|-------|----------|--------|---------------|
| | Mag. | Ang. | dB | Mag. | Ang. | Mag. | Ang. | Mag. | Ang. | |
| 0.1 | 0.995 | -6.8 | 22.92 | 13.988 | 175.4 | 0.005 | 86.4 | 0.772 | -3.4 | 34.47 |
| 0.5 | 0.943 | -33.0 | 22.35 | 13.103 | 155.9 | 0.024 | 70.6 | 0.72 | -15.7 | 27.37 |
| 0.9 | 0.883 | -56.9 | 21.53 | 11.932 | 140.7 | 0.04 | 59.4 | 0.662 | -27.1 | 24.75 |
| 1.0 | 0.87 | -62.4 | 21.30 | 11.616 | 137.3 | 0.043 | 56.9 | 0.643 | -29.6 | 24.32 |
| 1.5 | 0.798 | -87.6 | 20.00 | 10.004 | 121.6 | 0.056 | 46.2 | 0.557 | -40.2 | 22.52 |
| 1.9 | 0.752 | -104.9 | 18.91 | 8.822 | 111.0 | 0.063 | 39.6 | 0.494 | -46.7 | 21.46 |
| 2.0 | 0.743 | -108.8 | 18.65 | 8.557 | 108.6 | 0.064 | 38.2 | 0.48 | -48.1 | 21.26 |
| 2.5 | 0.704 | -126.7 | 17.35 | 7.367 | 97.8 | 0.069 | 32.3 | 0.417 | -54.2 | 20.28 |
| 3.0 | 0.68 | -142.1 | 16.14 | 6.411 | 88.4 | 0.072 | 27.8 | 0.367 | -59.0 | 19.50 |
| 4.0 | 0.66 | -166.3 | 14.02 | 5.026 | 72.8 | 0.076 | 22.0 | 0.297 | -67.2 | 18.20 |
| 5.0 | 0.662 | 175.2 | 12.25 | 4.095 | 59.5 | 0.079 | 18.6 | 0.251 | -75.7 | 17.15 |
| 6.0 | 0.664 | 162.6 | 10.84 | 3.483 | 48.4 | 0.083 | 17.4 | 0.216 | -80.7 | 16.23 |
| 7.0 | 0.667 | 150.9 | 9.61 | 3.022 | 37.6 | 0.087 | 16.1 | 0.199 | -90.4 | 14.69 |
| 8.0 | 0.67 | 141.2 | 8.61 | 2.695 | 27.3 | 0.093 | 14.8 | 0.185 | -100.6 | 13.08 |
| 9.0 | 0.679 | 130.8 | 7.71 | 2.429 | 16.9 | 0.099 | 13.0 | 0.177 | -113.5 | 12.08 |
| 10.0 | 0.677 | 118.1 | 6.90 | 2.213 | 6.0 | 0.107 | 9.9 | 0.178 | -127.2 | 11.08 |
| 11.0 | 0.683 | 105.4 | 6.17 | 2.034 | -4.6 | 0.116 | 6.4 | 0.186 | -140.4 | 10.44 |
| 12.0 | 0.688 | 91.4 | 5.46 | 1.876 | -15.8 | 0.126 | 1.8 | 0.198 | -152.2 | 9.85 |
| 13.0 | 0.705 | 80.9 | 4.72 | 1.722 | -26.5 | 0.136 | -3.2 | 0.193 | -165.9 | 9.37 |
| 14.0 | 0.741 | 66.5 | 4.03 | 1.59 | -38.3 | 0.146 | -9.8 | 0.188 | 173.7 | 9.78 |
| 15.0 | 0.75 | 55.0 | 3.19 | 1.444 | -49.5 | 0.154 | -16.5 | 0.2 | 151.1 | 8.35 |
| 16.0 | 0.803 | 45.1 | 2.22 | 1.291 | -60.1 | 0.159 | -23.2 | 0.224 | 129.5 | 9.10 |
| 17.0 | 0.823 | 37.2 | 1.26 | 1.156 | -70.3 | 0.165 | -29.8 | 0.269 | 107.3 | 8.45 |
| 18.0 | 0.872 | 31.0 | 0.27 | 1.032 | -80.2 | 0.168 | -36.6 | 0.325 | 88.8 | 7.88 |

Typical Noise Parameters, $V_{DS} = 2.7V$, $I_{DS} = 20\text{ mA}$

| Freq GHz | F_{min} dB | Γ_{opt} Mag. | Γ_{opt} Ang. | $R_{n/50}$ | G_a dB |
|-------------|-----------------|------------------------|------------------------|------------|-------------|
| 0.5 | 0.18 | 0.61 | -6.7 | 0.12 | 24.89 |
| 0.9 | 0.18 | 0.55 | 5.9 | 0.11 | 22.72 |
| 1.0 | 0.23 | 0.49 | 9.9 | 0.10 | 22.68 |
| 1.9 | 0.39 | 0.43 | 37.8 | 0.09 | 19.18 |
| 2.0 | 0.36 | 0.42 | 41.6 | 0.09 | 18.98 |
| 2.4 | 0.43 | 0.37 | 51.7 | 0.09 | 17.83 |
| 3.0 | 0.51 | 0.29 | 73.6 | 0.08 | 16.69 |
| 3.9 | 0.56 | 0.26 | 110.7 | 0.07 | 15.19 |
| 5.0 | 0.68 | 0.28 | 152.8 | 0.05 | 13.79 |
| 5.8 | 0.83 | 0.33 | 172.9 | 0.05 | 12.91 |
| 6.0 | 0.85 | 0.33 | 175.6 | 0.05 | 12.73 |
| 7.0 | 0.95 | 0.37 | -162.4 | 0.06 | 11.80 |
| 8.0 | 1.06 | 0.41 | -148.8 | 0.08 | 11.06 |
| 9.0 | 1.19 | 0.47 | -135.5 | 0.10 | 10.47 |
| 10.0 | 1.41 | 0.46 | -119.2 | 0.17 | 9.59 |

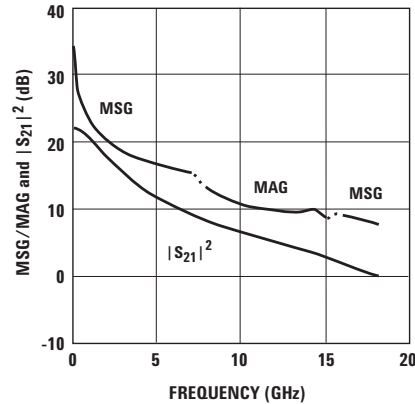

Figure 31. MSG/MAG and $|S_{21}|^2$ vs. Frequency at 2.7V, 20 mA.

Notes:

1. The F_{min} values are based on a set of 16 noise figure measurements made at 16 different impedances using an ATN NP5 test system. From these measurements F_{min} is calculated. Refer to the noise parameter measurement section for more information.
2. S and noise parameters are measured on a microstrip line made on 0.010 inch thick alumina carrier assembly. The input reference plane is at the end of the gate pad. The output reference plane is at the end of the drain pad.

ATF-551M4 Typical Scattering Parameters, $V_{DS} = 3V, I_{DS} = 10\text{ mA}$

| Freq. GHz | S_{11} | | | S_{21} | | S_{12} | | S_{22} | | MSG/MAG dB |
|--------------|----------|--------|-------|----------|-------|----------|-------|----------|--------|---------------|
| | Mag. | Ang. | dB | Mag. | Ang. | Mag. | Ang. | Mag. | Ang. | |
| 0.1 | 0.996 | -5.9 | 20.49 | 10.578 | 176.0 | 0.006 | 86.1 | 0.835 | -2.8 | 32.46 |
| 0.5 | 0.957 | -28.4 | 20.05 | 10.059 | 158.5 | 0.027 | 72.0 | 0.792 | -13.4 | 25.71 |
| 0.9 | 0.909 | -49.6 | 19.48 | 9.420 | 144.8 | 0.045 | 61.5 | 0.747 | -23.5 | 23.21 |
| 1.0 | 0.899 | -54.6 | 19.32 | 9.246 | 141.6 | 0.049 | 59.1 | 0.730 | -25.9 | 22.76 |
| 1.5 | 0.836 | -78.1 | 18.32 | 8.241 | 126.3 | 0.065 | 47.9 | 0.653 | -36.1 | 21.03 |
| 1.9 | 0.792 | -94.9 | 17.41 | 7.424 | 115.7 | 0.074 | 40.3 | 0.593 | -42.7 | 20.01 |
| 2.0 | 0.782 | -98.8 | 17.20 | 7.241 | 113.2 | 0.075 | 38.6 | 0.578 | -44.2 | 19.85 |
| 2.5 | 0.740 | -116.8 | 16.07 | 6.360 | 101.9 | 0.082 | 31.3 | 0.513 | -50.7 | 18.90 |
| 3.0 | 0.709 | -132.8 | 14.99 | 5.616 | 91.9 | 0.086 | 25.3 | 0.458 | -56.0 | 18.15 |
| 4.0 | 0.680 | -158.5 | 13.03 | 4.481 | 75.1 | 0.090 | 16.9 | 0.378 | -64.9 | 16.97 |
| 5.0 | 0.675 | -178.4 | 11.33 | 3.684 | 60.9 | 0.091 | 11.3 | 0.325 | -73.5 | 16.07 |
| 6.0 | 0.675 | 167.8 | 9.96 | 3.146 | 49.1 | 0.092 | 8.7 | 0.287 | -79.1 | 15.34 |
| 7.0 | 0.676 | 155.1 | 8.75 | 2.738 | 37.6 | 0.093 | 6.6 | 0.267 | -88.4 | 14.69 |
| 8.0 | 0.678 | 144.9 | 7.77 | 2.447 | 26.8 | 0.095 | 5.4 | 0.252 | -98.6 | 12.90 |
| 9.0 | 0.686 | 133.8 | 6.88 | 2.209 | 16.0 | 0.099 | 4.1 | 0.242 | -110.5 | 11.73 |
| 10.0 | 0.682 | 120.5 | 6.09 | 2.015 | 4.7 | 0.104 | 2.1 | 0.241 | -122.9 | 10.56 |
| 11.0 | 0.688 | 107.5 | 5.37 | 1.855 | -6.3 | 0.110 | 0.0 | 0.247 | -135.1 | 9.88 |
| 12.0 | 0.694 | 93.3 | 4.67 | 1.711 | -17.8 | 0.118 | -3.4 | 0.256 | -146.5 | 9.26 |
| 13.0 | 0.711 | 82.4 | 3.92 | 1.571 | -28.8 | 0.127 | -6.9 | 0.250 | -159.0 | 8.76 |
| 14.0 | 0.746 | 67.5 | 3.24 | 1.452 | -40.8 | 0.137 | -12.6 | 0.240 | -176.5 | 8.90 |
| 15.0 | 0.753 | 55.9 | 2.41 | 1.320 | -52.4 | 0.146 | -18.5 | 0.246 | 163.0 | 7.74 |
| 16.0 | 0.807 | 45.8 | 1.46 | 1.183 | -63.1 | 0.152 | -24.5 | 0.260 | 142.0 | 8.91 |
| 17.0 | 0.826 | 37.6 | 0.48 | 1.057 | -73.7 | 0.159 | -30.8 | 0.297 | 119.0 | 8.23 |
| 18.0 | 0.874 | 31.3 | -0.53 | 0.941 | -84.1 | 0.164 | -37.5 | 0.349 | 98.9 | 7.59 |

Typical Noise Parameters, $V_{DS} = 3V, I_{DS} = 10\text{ mA}$

| Freq GHz | F_{min} dB | Γ_{opt} Mag. | Γ_{opt} Ang. | $R_{n/50}$ | G_a dB |
|-------------|-----------------|------------------------|------------------------|------------|-------------|
| 0.5 | 0.23 | 0.65 | -4.3 | 0.14 | 23.81 |
| 0.9 | 0.24 | 0.58 | 7.4 | 0.13 | 21.82 |
| 1.0 | 0.26 | 0.54 | 10.7 | 0.13 | 21.62 |
| 1.9 | 0.43 | 0.50 | 36.2 | 0.11 | 18.05 |
| 2.0 | 0.38 | 0.48 | 40.4 | 0.12 | 17.96 |
| 2.4 | 0.43 | 0.44 | 49.8 | 0.11 | 16.84 |
| 3.0 | 0.51 | 0.36 | 69.2 | 0.10 | 15.76 |
| 3.9 | 0.59 | 0.31 | 99.4 | 0.08 | 14.23 |
| 5.0 | 0.70 | 0.32 | 139.3 | 0.06 | 12.94 |
| 5.8 | 0.85 | 0.35 | 160.3 | 0.05 | 12.04 |
| 6.0 | 0.86 | 0.35 | 162.3 | 0.05 | 11.85 |
| 7.0 | 0.98 | 0.36 | -173.7 | 0.06 | 10.99 |
| 8.0 | 1.09 | 0.41 | -158.6 | 0.07 | 10.29 |
| 9.0 | 1.23 | 0.45 | -143.7 | 0.09 | 9.71 |
| 10.0 | 1.45 | 0.44 | -126.8 | 0.15 | 8.88 |

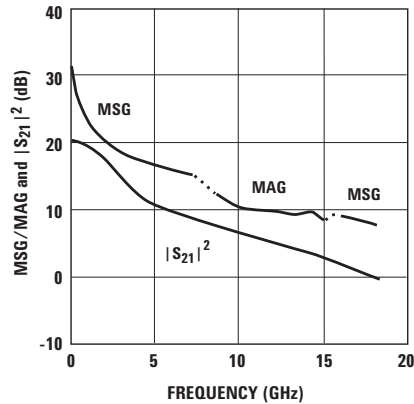

Figure 32. MSG/MAG and $|S_{21}|^2$ vs. Frequency at 3V, 10 mA.

Notes:

1. The F_{min} values are based on a set of 16 noise figure measurements made at 16 different impedances using an ATN NP5 test system. From these measurements F_{min} is calculated. Refer to the noise parameter measurement section for more information.
2. S and noise parameters are measured on a microstrip line made on 0.010 inch thick alumina carrier assembly. The input reference plane is at the end of the gate pad. The output reference plane is at the end of the drain pad.

ATF-551M4 Typical Scattering Parameters, $V_{DS} = 3V, I_{DS} = 15\text{ mA}$

| Freq. GHz | S_{11} | | | S_{21} | | S_{12} | | S_{22} | | MSG/MAG dB |
|--------------|----------|--------|-------|----------|-------|----------|-------|----------|--------|---------------|
| | Mag. | Ang. | dB | Mag. | Ang. | Mag. | Ang. | Mag. | Ang. | |
| 0.1 | 0.995 | -6.5 | 22.02 | 12.623 | 175.6 | 0.005 | 86.0 | 0.802 | -3.1 | 34.02 |
| 0.5 | 0.949 | -31.2 | 21.51 | 11.900 | 156.9 | 0.025 | 71.0 | 0.754 | -14.6 | 26.78 |
| 0.9 | 0.894 | -54.1 | 20.79 | 10.958 | 142.3 | 0.041 | 60.1 | 0.700 | -25.4 | 24.27 |
| 1.0 | 0.882 | -59.4 | 20.59 | 10.701 | 138.9 | 0.045 | 57.6 | 0.682 | -27.8 | 23.76 |
| 1.5 | 0.813 | -84.0 | 19.41 | 9.341 | 123.3 | 0.059 | 46.7 | 0.599 | -38.1 | 22.00 |
| 1.9 | 0.768 | -101.2 | 18.38 | 8.301 | 112.7 | 0.066 | 39.7 | 0.537 | -44.5 | 21.00 |
| 2.0 | 0.758 | -105.1 | 18.14 | 8.068 | 110.3 | 0.067 | 38.1 | 0.522 | -45.9 | 20.81 |
| 2.5 | 0.717 | -123.1 | 16.90 | 6.996 | 99.2 | 0.073 | 31.6 | 0.459 | -52.0 | 19.82 |
| 3.0 | 0.690 | -138.7 | 15.74 | 6.120 | 89.7 | 0.076 | 26.7 | 0.407 | -56.9 | 19.06 |
| 4.0 | 0.668 | -163.5 | 13.68 | 4.829 | 73.6 | 0.080 | 20.0 | 0.334 | -65.0 | 17.81 |
| 5.0 | 0.666 | 177.5 | 11.93 | 3.947 | 59.9 | 0.082 | 15.8 | 0.286 | -73.3 | 16.82 |
| 6.0 | 0.668 | 164.4 | 10.53 | 3.363 | 48.5 | 0.084 | 14.2 | 0.250 | -78.4 | 16.02 |
| 7.0 | 0.670 | 152.3 | 9.31 | 2.921 | 37.5 | 0.087 | 12.9 | 0.232 | -87.6 | 14.96 |
| 8.0 | 0.672 | 142.4 | 8.32 | 2.607 | 27.0 | 0.092 | 11.8 | 0.218 | -97.7 | 12.99 |
| 9.0 | 0.681 | 131.7 | 7.43 | 2.351 | 16.4 | 0.098 | 10.4 | 0.209 | -110.0 | 12.01 |
| 10.0 | 0.678 | 118.6 | 6.62 | 2.142 | 5.3 | 0.104 | 7.8 | 0.209 | -122.9 | 10.90 |
| 11.0 | 0.684 | 105.8 | 5.89 | 1.970 | -5.5 | 0.113 | 4.9 | 0.215 | -135.4 | 10.28 |
| 12.0 | 0.690 | 91.8 | 5.19 | 1.817 | -16.8 | 0.122 | 0.7 | 0.226 | -147.1 | 9.70 |
| 13.0 | 0.707 | 81.3 | 4.44 | 1.667 | -27.6 | 0.132 | -3.7 | 0.221 | -160.3 | 9.23 |
| 14.0 | 0.744 | 66.6 | 3.75 | 1.540 | -39.5 | 0.142 | -10.0 | 0.211 | -179.5 | 9.62 |
| 15.0 | 0.751 | 55.2 | 2.93 | 1.401 | -50.7 | 0.151 | -16.4 | 0.218 | 159.7 | 8.26 |
| 16.0 | 0.807 | 45.3 | 1.97 | 1.254 | -61.4 | 0.157 | -22.8 | 0.236 | 137.8 | 9.02 |
| 17.0 | 0.824 | 37.3 | 1.01 | 1.123 | -71.9 | 0.163 | -29.5 | 0.277 | 114.5 | 8.38 |
| 18.0 | 0.874 | 31.1 | 0.02 | 1.002 | -82.0 | 0.167 | -36.2 | 0.330 | 95.0 | 7.78 |

Typical Noise Parameters, $V_{DS} = 3V, I_{DS} = 15\text{ mA}$

| Freq GHz | F_{min} dB | Γ_{opt} Mag. | Γ_{opt} Ang. | $R_{n/50}$ | G_a dB |
|-------------|-----------------|------------------------|------------------------|------------|-------------|
| 0.5 | 0.18 | 0.63 | -6.3 | 0.12 | 24.41 |
| 0.9 | 0.19 | 0.56 | 6.8 | 0.12 | 22.45 |
| 1.0 | 0.23 | 0.51 | 10.0 | 0.11 | 22.29 |
| 1.9 | 0.39 | 0.46 | 36.5 | 0.10 | 18.75 |
| 2.0 | 0.35 | 0.44 | 40.8 | 0.10 | 18.61 |
| 2.4 | 0.42 | 0.39 | 50.1 | 0.10 | 17.46 |
| 3.0 | 0.49 | 0.31 | 72.5 | 0.08 | 16.42 |
| 3.9 | 0.56 | 0.27 | 104.4 | 0.07 | 14.80 |
| 5.0 | 0.66 | 0.29 | 146.9 | 0.06 | 13.48 |
| 5.8 | 0.83 | 0.33 | 167.4 | 0.05 | 12.58 |
| 6.0 | 0.84 | 0.33 | 169.0 | 0.05 | 12.38 |
| 7.0 | 0.94 | 0.35 | -166.9 | 0.06 | 11.49 |
| 8.0 | 1.05 | 0.40 | -152.7 | 0.07 | 10.77 |
| 9.0 | 1.19 | 0.46 | -138.6 | 0.09 | 10.23 |
| 10.0 | 1.40 | 0.44 | -121.9 | 0.16 | 9.32 |

Notes:

1. The F_{min} values are based on a set of 16 noise figure measurements made at 16 different impedances using an ATN NP5 test system. From these measurements F_{min} is calculated. Refer to the noise parameter measurement section for more information.
2. S and noise parameters are measured on a microstrip line made on 0.010 inch thick alumina carrier assembly. The input reference plane is at the end of the gate pad. The output reference plane is at the end of the drain pad.

ATF-551M4 Typical Scattering Parameters, $V_{DS} = 3V, I_{DS} = 20\text{ mA}$

| Freq. GHz | S_{11} | | | S_{21} | | S_{12} | | S_{22} | | MSG/MAG dB |
|--------------|----------|--------|-------|----------|-------|----------|-------|----------|--------|---------------|
| | Mag. | Ang. | dB | Mag. | Ang. | Mag. | Ang. | Mag. | Ang. | |
| 0.1 | 0.995 | -6.8 | 22.91 | 13.987 | 175.4 | 0.005 | 86.1 | 0.781 | -3.3 | 34.47 |
| 0.5 | 0.943 | -33.0 | 22.35 | 13.101 | 155.8 | 0.024 | 70.5 | 0.730 | -15.2 | 27.37 |
| 0.9 | 0.883 | -56.9 | 21.53 | 11.932 | 140.7 | 0.039 | 59.5 | 0.672 | -26.1 | 24.86 |
| 1.0 | 0.870 | -62.4 | 21.30 | 11.614 | 137.2 | 0.042 | 56.9 | 0.654 | -28.5 | 24.42 |
| 1.5 | 0.798 | -87.6 | 20.00 | 10.004 | 121.5 | 0.054 | 46.3 | 0.569 | -38.5 | 22.68 |
| 1.9 | 0.752 | -104.9 | 18.91 | 8.820 | 111.0 | 0.061 | 39.7 | 0.506 | -44.6 | 21.60 |
| 2.0 | 0.743 | -108.9 | 18.64 | 8.555 | 108.6 | 0.062 | 38.3 | 0.493 | -46.0 | 21.40 |
| 2.5 | 0.704 | -126.7 | 17.35 | 7.368 | 97.7 | 0.067 | 32.4 | 0.431 | -51.6 | 20.41 |
| 3.0 | 0.679 | -142.1 | 16.14 | 6.412 | 88.4 | 0.070 | 28.1 | 0.383 | -56.0 | 19.62 |
| 4.0 | 0.660 | -166.3 | 14.03 | 5.028 | 72.7 | 0.074 | 22.5 | 0.314 | -63.5 | 18.32 |
| 5.0 | 0.662 | 175.3 | 12.25 | 4.099 | 59.4 | 0.076 | 19.2 | 0.270 | -71.5 | 17.32 |
| 6.0 | 0.664 | 162.6 | 10.85 | 3.488 | 48.3 | 0.080 | 18.3 | 0.237 | -76.2 | 16.39 |
| 7.0 | 0.667 | 150.9 | 9.62 | 3.027 | 37.5 | 0.084 | 17.2 | 0.220 | -85.2 | 14.66 |
| 8.0 | 0.670 | 141.3 | 8.63 | 2.701 | 27.2 | 0.090 | 16.3 | 0.207 | -95.2 | 13.18 |
| 9.0 | 0.679 | 130.9 | 7.73 | 2.435 | 16.8 | 0.096 | 14.6 | 0.198 | -107.6 | 12.20 |
| 10.0 | 0.677 | 118.1 | 6.92 | 2.219 | 5.9 | 0.104 | 11.7 | 0.198 | -120.6 | 11.21 |
| 11.0 | 0.683 | 105.4 | 6.19 | 2.040 | -4.8 | 0.114 | 8.4 | 0.205 | -133.4 | 10.64 |
| 12.0 | 0.689 | 91.4 | 5.49 | 1.881 | -16.0 | 0.124 | 3.8 | 0.216 | -145.2 | 10.10 |
| 13.0 | 0.705 | 80.9 | 4.75 | 1.727 | -26.8 | 0.134 | -1.0 | 0.210 | -158.4 | 9.62 |
| 14.0 | 0.742 | 66.4 | 4.05 | 1.594 | -38.6 | 0.145 | -7.7 | 0.199 | -178.0 | 10.41 |
| 15.0 | 0.751 | 55.0 | 3.23 | 1.451 | -49.8 | 0.153 | -14.4 | 0.207 | 160.3 | 8.80 |
| 16.0 | 0.806 | 45.1 | 2.27 | 1.298 | -60.4 | 0.159 | -21.1 | 0.225 | 138.1 | 9.12 |
| 17.0 | 0.826 | 37.2 | 1.32 | 1.164 | -70.8 | 0.165 | -27.9 | 0.265 | 114.0 | 8.48 |
| 18.0 | 0.874 | 31.1 | 0.33 | 1.039 | -80.8 | 0.170 | -34.9 | 0.320 | 94.1 | 7.86 |

Typical Noise Parameters, $V_{DS} = 3V, I_{DS} = 20\text{ mA}$

| Freq GHz | F_{min} dB | Γ_{opt} Mag. | Γ_{opt} Ang. | $R_{n/50}$ | G_a dB |
|-------------|-----------------|------------------------|------------------------|------------|-------------|
| 0.5 | 0.17 | 0.62 | -6.2 | 0.12 | 24.92 |
| 0.9 | 0.18 | 0.55 | 6.0 | 0.11 | 22.79 |
| 1.0 | 0.24 | 0.50 | 9.5 | 0.10 | 22.59 |
| 1.9 | 0.39 | 0.43 | 37.5 | 0.10 | 19.22 |
| 2.0 | 0.36 | 0.41 | 41.2 | 0.09 | 19.00 |
| 2.4 | 0.42 | 0.37 | 50.9 | 0.09 | 17.83 |
| 3.0 | 0.50 | 0.29 | 73.6 | 0.08 | 16.72 |
| 3.9 | 0.57 | 0.25 | 109.4 | 0.07 | 15.18 |
| 5.0 | 0.68 | 0.28 | 151.6 | 0.06 | 13.80 |
| 5.8 | 0.83 | 0.32 | 172.5 | 0.05 | 12.93 |
| 6.0 | 0.85 | 0.33 | 175.6 | 0.05 | 12.77 |
| 7.0 | 0.93 | 0.36 | -162.7 | 0.06 | 11.84 |
| 8.0 | 1.05 | 0.41 | -149.1 | 0.08 | 11.09 |
| 9.0 | 1.19 | 0.46 | -135.5 | 0.10 | 10.53 |
| 10.0 | 1.39 | 0.45 | -119.4 | 0.17 | 9.64 |

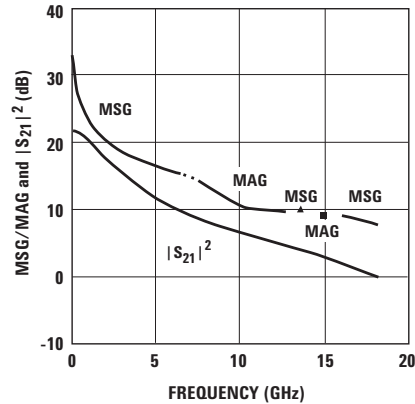

Figure 34. MSG/MAG and $|S_{21}|^2$ vs. Frequency at 3V, 20 mA.

Notes:

1. The F_{min} values are based on a set of 16 noise figure measurements made at 16 different impedances using an ATN NP5 test system. From these measurements F_{min} is calculated. Refer to the noise parameter measurement section for more information.
2. S and noise parameters are measured on a microstrip line made on 0.010 inch thick alumina carrier assembly. The input reference plane is at the end of the gate pad. The output reference plane is at the end of the drain pad.

ATF-551M4 Typical Scattering Parameters, $V_{DS} = 3V, I_{DS} = 30\text{ mA}$

| Freq. GHz | S_{11} | | | S_{21} | | S_{12} | | S_{22} | | MSG/MAG dB |
|--------------|----------|--------|-------|----------|-------|----------|-------|----------|--------|---------------|
| | Mag. | Ang. | dB | Mag. | Ang. | Mag. | Ang. | Mag. | Ang. | |
| 0.1 | 0.994 | -7.4 | 23.90 | 15.662 | 175.0 | 0.005 | 86.1 | 0.760 | -3.4 | 34.96 |
| 0.5 | 0.936 | -35.3 | 23.25 | 14.544 | 154.5 | 0.022 | 69.8 | 0.705 | -15.4 | 28.20 |
| 0.9 | 0.870 | -60.4 | 22.32 | 13.058 | 138.7 | 0.035 | 58.7 | 0.644 | -26.2 | 25.72 |
| 1.0 | 0.856 | -66.1 | 22.05 | 12.665 | 135.2 | 0.038 | 56.2 | 0.624 | -28.5 | 25.23 |
| 1.5 | 0.781 | -92.0 | 20.61 | 10.732 | 119.4 | 0.048 | 46.0 | 0.539 | -37.7 | 23.49 |
| 1.9 | 0.736 | -109.4 | 19.44 | 9.374 | 108.9 | 0.054 | 40.1 | 0.480 | -43.1 | 22.40 |
| 2.0 | 0.726 | -113.3 | 19.15 | 9.072 | 106.6 | 0.055 | 38.8 | 0.467 | -44.2 | 22.17 |
| 2.5 | 0.690 | -131.0 | 17.79 | 7.753 | 96.0 | 0.059 | 33.7 | 0.410 | -49.0 | 21.19 |
| 3.0 | 0.668 | -146.1 | 16.54 | 6.713 | 86.9 | 0.062 | 30.3 | 0.367 | -52.7 | 20.35 |
| 4.0 | 0.653 | -169.6 | 14.38 | 5.234 | 71.7 | 0.066 | 26.1 | 0.307 | -59.2 | 18.99 |
| 5.0 | 0.656 | 172.7 | 12.58 | 4.258 | 58.7 | 0.069 | 23.8 | 0.268 | -66.7 | 17.90 |
| 6.0 | 0.659 | 160.5 | 11.17 | 3.618 | 47.9 | 0.074 | 23.6 | 0.238 | -70.9 | 16.89 |
| 7.0 | 0.663 | 149.0 | 9.93 | 3.138 | 37.2 | 0.079 | 22.9 | 0.224 | -79.8 | 14.61 |
| 8.0 | 0.666 | 139.6 | 8.94 | 2.798 | 27.1 | 0.086 | 21.9 | 0.211 | -89.5 | 13.35 |
| 9.0 | 0.676 | 129.3 | 8.03 | 2.522 | 16.8 | 0.094 | 20.1 | 0.203 | -101.5 | 12.55 |
| 10.0 | 0.674 | 116.6 | 7.22 | 2.296 | 5.9 | 0.103 | 16.9 | 0.202 | -114.5 | 11.58 |
| 11.0 | 0.680 | 104.1 | 6.48 | 2.109 | -4.6 | 0.113 | 13.1 | 0.208 | -127.3 | 11.01 |
| 12.0 | 0.688 | 90.3 | 5.77 | 1.944 | -15.8 | 0.124 | 8.0 | 0.219 | -139.4 | 10.62 |
| 13.0 | 0.705 | 80.1 | 5.03 | 1.784 | -26.4 | 0.135 | 3.0 | 0.213 | -152.3 | 10.38 |
| 14.0 | 0.743 | 65.8 | 4.34 | 1.648 | -38.0 | 0.147 | -4.1 | 0.200 | -170.8 | 10.50 |
| 15.0 | 0.751 | 54.5 | 3.53 | 1.502 | -49.2 | 0.156 | -11.1 | 0.203 | 166.8 | 9.84 |
| 16.0 | 0.806 | 44.9 | 2.56 | 1.343 | -59.8 | 0.162 | -18.1 | 0.218 | 143.9 | 9.19 |
| 17.0 | 0.826 | 37.0 | 1.64 | 1.208 | -70.1 | 0.168 | -25.2 | 0.254 | 118.4 | 8.57 |
| 18.0 | 0.875 | 31.0 | 0.67 | 1.080 | -80.2 | 0.174 | -32.4 | 0.306 | 97.4 | 7.93 |

Typical Noise Parameters, $V_{DS} = 3V, I_{DS} = 30\text{ mA}$

| Freq GHz | F_{min} dB | Γ_{opt} Mag. | Γ_{opt} Ang. | $R_{n/50}$ | G_a dB |
|-------------|-----------------|------------------------|------------------------|------------|-------------|
| 0.5 | 0.16 | 0.60 | -6.2 | 0.11 | 25.60 |
| 0.9 | 0.18 | 0.55 | 6.4 | 0.11 | 23.17 |
| 1.0 | 0.24 | 0.47 | 10.1 | 0.10 | 23.19 |
| 1.9 | 0.39 | 0.39 | 39.1 | 0.09 | 19.73 |
| 2.0 | 0.36 | 0.38 | 42.7 | 0.09 | 19.48 |
| 2.4 | 0.45 | 0.33 | 54.2 | 0.09 | 18.36 |
| 3.0 | 0.52 | 0.26 | 79.0 | 0.08 | 17.20 |
| 3.9 | 0.59 | 0.23 | 119.0 | 0.06 | 15.66 |
| 5.0 | 0.71 | 0.28 | 162.1 | 0.05 | 14.28 |
| 5.8 | 0.86 | 0.33 | -179.3 | 0.05 | 13.39 |
| 6.0 | 0.89 | 0.33 | -176.7 | 0.05 | 13.20 |
| 7.0 | 0.99 | 0.37 | -156.1 | 0.07 | 12.27 |
| 8.0 | 1.12 | 0.42 | -143.5 | 0.09 | 11.50 |
| 9.0 | 1.26 | 0.48 | -130.8 | 0.12 | 10.96 |
| 10.0 | 1.50 | 0.46 | -115.1 | 0.20 | 10.01 |

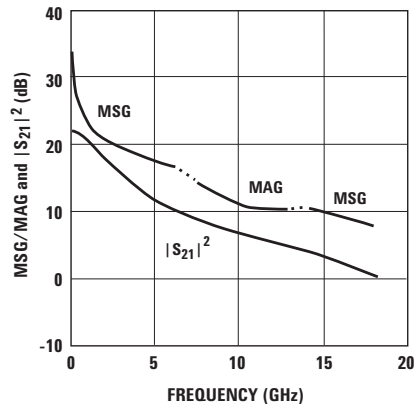

Figure 35. MSG/MAG and $|S_{21}|^2$ vs. Frequency at 3V, 30 mA.

Notes:

1. The F_{min} values are based on a set of 16 noise figure measurements made at 16 different impedances using an ATN NP5 test system. From these measurements F_{min} is calculated. Refer to the noise parameter measurement section for more information.
2. S and noise parameters are measured on a microstrip line made on 0.010 inch thick alumina carrier assembly. The input reference plane is at the end of the gate pad. The output reference plane is at the end of the drain pad.

S and Noise Parameter Measurements

The position of the reference planes used for the measurement of both S and Noise Parameter measurements is shown in Figure 36. The reference plane can be described as being at the center of both the gate and drain pads.

S and noise parameters are measured with a 50 ohm microstrip test fixture made with a 0.010" thickness aluminum substrate. Both source pads are connected directly to ground via a 0.010" thickness metal rib which provides a very low inductance path to ground for both source pads. The inductance associated with the addition of printed circuit board plated through holes and source bypass capacitors must be added to the computer circuit simulation to properly model the effect of grounding the source leads in a typical amplifier design.

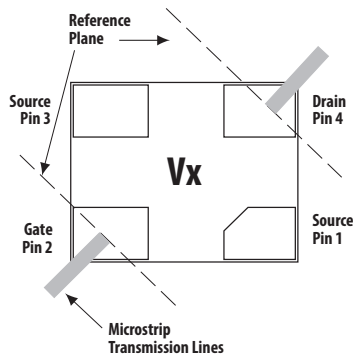

Figure 36. Position of the Reference Planes.

Noise Parameter Applications Information

The F_{min} values are based on a set of 16 noise figure measurements made at 16 different impedances using an ATN NP5 test system. From these measurements, a true F_{min} is calculated. F_{min} represents the true minimum noise figure of the device when the device is presented with an impedance matching network that transforms the source impedance, typically 50Ω , to an impedance represented by the reflection coefficient Γ_o . The designer must design a matching network that will present Γ_o to the device with minimal associated circuit losses. The noise figure of the completed amplifier is equal to the noise figure of the device plus the losses of the matching network preceding the device. The noise figure of the device is equal to F_{min} only when the device is presented with Γ_o . If the reflection coefficient of the matching network is other than Γ_o , then the noise figure of the device will be greater than F_{min} based on the following equation.

$$NF = F_{min} + 4 R_n \frac{|\Gamma_s - \Gamma_o|^2}{Z_o (|1 + \Gamma_o|^2)(1 - |\Gamma_s|^2)}$$

Where R_n/Z_o is the normalized noise resistance, Γ_o is the optimum reflection coefficient required to produce F_{min} and Γ_s is the reflection coefficient of the source impedance actually presented to the device.

The losses of the matching networks are non-zero and they will also add to the noise figure of the device creating a higher amplifier noise figure. The losses of the matching networks are related to the Q of the components and associated printed circuit board loss. Γ_o is typically fairly low at higher frequencies and increases as frequency is lowered. Larger gate width devices will typically have a lower Γ_o as compared to narrower gate width devices. Typically for FETs, the higher Γ_o usually infers that an impedance much higher than 50Ω is required for the device to produce F_{min} . At VHF frequencies and even lower L Band frequencies, the required impedance can be in the vicinity of several thousand ohms. Matching to such a high impedance requires very hi-Q components in order to minimize circuit losses. As an example at 900 MHz, when air wound coils ($Q > 100$) are used for matching networks, the loss can still be up to 0.25 dB which will add directly to the noise figure of the device. Using multilayer molded inductors with Qs in the 30 to 50 range results in additional loss over the air wound coil. Losses as high as 0.5 dB or greater add to the typical 0.15 dB F_{min} of the device creating an amplifier noise figure of nearly 0.65 dB.

ATF-551M4 Applications Information

Introduction

Avago Technologies's ATF-551M4 is a low noise enhancement mode PHEMT designed for use in low cost commercial applications in the VHF through 10 GHz frequency range. As opposed to a typical depletion mode PHEMT where the gate must be made negative with respect to the source for proper operation, an enhancement mode PHEMT requires that the gate be made more positive than the source for normal operation. Therefore a negative power supply voltage is not required for an enhancement mode device. Biasing an enhancement mode PHEMT is much like biasing the typical bipolar junction transistor. Instead of a 0.7V base to emitter voltage, the ATF-551M4 enhancement mode PHEMT requires a nominal 0.47V potential between the gate and source for a nominal drain current of 10 mA.

Matching Networks

The techniques for impedance matching an enhancement mode device are very similar to those for matching a depletion mode device. The only difference is in the method of supplying gate bias. S and Noise Parameters for various bias conditions are listed in this data sheet. The circuit shown in Figure 37 shows a typical LNA circuit normally used for 900 and 1900 MHz applications. Consult the Avago Technologies web site for application notes covering specific designs and applications. High pass impedance matching networks consisting of L1/C1 and L4/C4 provide the appropriate match for noise figure, gain, S11 and S22. The high pass structure also provides low frequency gain reduction which can be beneficial from the standpoint of improving out-of-band rejection.

Capacitors C2 and C5 provide a low impedance in-band RF bypass for the matching networks. Resistors R3 and R4 provide a very important low frequency termination for the device. The resistive termination improves low frequency stability. Capacitors C3 and C6 provide the RF bypass for resistors R3 and R4. Their value should be chosen carefully as C3 and C6 also provide a termination for low frequency mixing products. These mixing products are as a result of two or more in-band signals mixing and producing third order in-band distortion products. The low frequency or difference mixing products are terminated by C3 and C6. For best suppression of third order distortion products based on the CDMA 1.25 MHz signal spacing, C3 and C6 should be 0.1 uF in value. Smaller values of capacitance will not suppress the generation of the 1.25 MHz difference signal and as a result will show up as poorer two tone IP3 results.

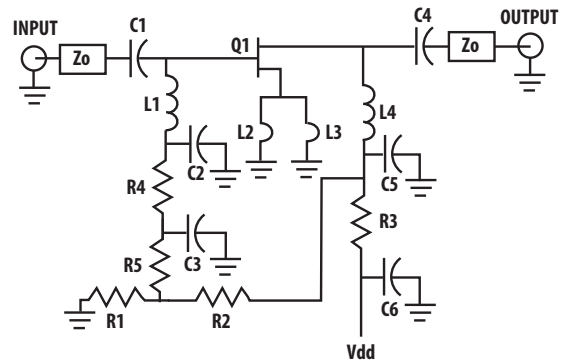

Figure 37. Typical ATF-551M4 LNA with Passive Biasing.

Bias Networks

One of the major advantages of the enhancement mode technology is that it allows the designer to be able to dc ground the source leads and then merely apply a positive voltage on the gate to set the desired amount of quiescent drain current I_d .

Whereas a depletion mode PHEMT pulls maximum drain current when $V_{gs}=0V$, an enhancement mode PHEMT pulls only a small amount of leakage current when $V_{gs}=0V$. Only when V_{gs} is increased above V_{th} , the device threshold voltage, will drain current start to flow. At a V_{ds} of 2.7V and a nominal V_{gs} of 0.47V, the drain current I_d will be approximately 10 mA. The data sheet suggests a minimum and maximum V_{gs} over which the desired amount of drain current will be achieved. It is also important to note that if the gate terminal is left open circuited, the device will pull some amount of drain current due to leakage current creating a voltage differential between the gate and source terminals.

Passive Biasing

Passive biasing of the ATF-551M4 is accomplished by the use of a voltage divider consisting of R1 and R2. The voltage for the divider is derived from the drain voltage which provides a form of voltage feedback through the use of R3 to help keep drain current constant. In the case of a typical depletion mode FET, the voltage divider which is normally connected to a negative voltage source is connected to the gate through resistor R4. Additional resistance in the form of R5 (approximately 10KΩ) is added to provide current limiting for the gate of enhancement mode devices such as the ATF-551M4. This is especially important when the device is driven to P1dB or Psat.

Resistor R3 is calculated based on desired V_{ds} , I_{ds} and available power supply voltage.

$$R3 = \frac{V_{DD} - V_{ds}}{I_{ds} + I_{BB}} \quad (1)$$

V_{DD} is the power supply voltage.

V_{ds} is the device drain to source voltage.

I_{ds} is the desired drain current.

I_{BB} is the current flowing through the R1/R2 resistor voltage divider network.

The value of resistors R1 and R2 are calculated with the following formulas.

$$R1 = \frac{V_{gs}}{I_{BB}} \quad (2)$$

$$R2 = \frac{(V_{ds} - V_{gs}) R1}{V_{gs}} \quad (3)$$

Example Circuit

$$V_{DD} = 3V$$

$$V_{ds} = 2.7V$$

$$I_{ds} = 10 \text{ mA}$$

$$V_{gs} = 0.47V$$

Choose I_{BB} to be at least 10X the maximum expected gate leakage current. I_{BB} was conservatively chosen to be 0.5 mA for this example. Using equations (1), (2), and (3) the resistors are calculated as follows

$$R1 = 940\Omega$$

$$R2 = 4460\Omega$$

$$R3 = 28.6\Omega$$

Active Biasing

Active biasing provides a means of keeping the quiescent bias point constant over temperature and constant over lot to lot variations in device dc performance. The advantage of the active biasing of an enhancement mode PHEMT versus a depletion mode PHEMT is that a negative power source is not required.

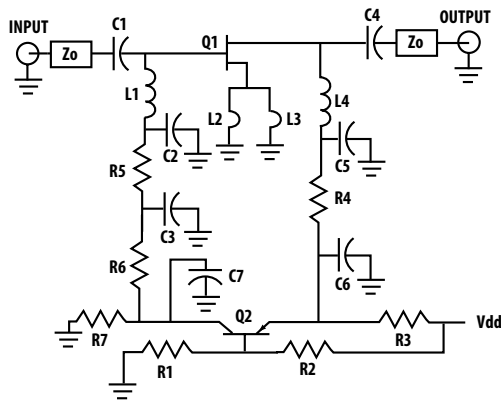

Figure 38. Typical ATF-551M4 LNA with Active Biasing.

The techniques of active biasing an enhancement mode device are very similar to those used to bias a bipolar junction transistor. An active bias scheme is shown in Figure 38.

R1 and R2 provide a constant voltage source at the base of a PNP transistor at Q2. The constant voltage at the base of Q2 is raised by 0.7 volts at the emitter. The constant emitter voltage plus the regulated V_{DD} supply are present across resistor R3. Constant voltage across R3 provides a constant current supply for the drain current. Resistors R1 and R2 are used to set the desired V_{ds} . The combined series value of these resistors also sets the amount of extra current consumed by the bias network. The equations that describe the circuit's operation are as follows.

$$V_E = V_{ds} + (I_{ds} \cdot R4) \quad (1)$$

$$R3 = \frac{V_{DD} - V_E}{I_{ds}} \quad (2)$$

$$V_B = V_E - V_{BE} \quad (3)$$

$$V_B = \frac{R1}{R1 + R2} V_{DD} \quad (4)$$

$$V_{DD} = I_{BB} (R1 + R2) \quad (5)$$

Rearranging equation (4) provides the following formula

$$R2 = \frac{R1 (V_{DD} - V_B)}{V_B} \quad (4A)$$

and rearranging equation (5) provides the following formula

$$R1 = \frac{V_{DD}}{I_{BB} \left(1 + \frac{V_{DD} - V_B}{V_B} \right)} \quad (5A)$$

Example Circuit

$$V_{DD} = 3V, V_{ds} = 2.7V, I_{ds} = 10 \text{ mA}, R4 = 10\Omega, V_{BE} = 0.7V$$

Equation (1) calculates the required voltage at the emitter of the PNP transistor based on desired V_{ds} and I_{ds} through resistor R4 to be 2.8V. Equation (2) calculates the value of resistor R3 which determines the drain current I_{ds} . In the example $R3=18.2\Omega$. Equation (3) calculates the voltage required at the junction of resistors R1 and R2. This voltage plus the step-up of the base emitter junction determines the regulated V_{ds} . Equations (4) and (5) are solved simultaneously to determine the value of resistors R1 and R2. In the example $R1=4200\Omega$ and $R2=1800\Omega$.

R7 is chosen to be 1 kΩ. This resistor keeps a small amount of current flowing through Q2 to help maintain bias stability. R6 is chosen to be 10 kΩ. This value of resistance is high enough to limit Q1 gate current in the presence of high RF drive levels as experienced when Q1 is driven to the P1dB gain compression point. C7 provides a low frequency bypass to keep noise from Q2 effecting the operation of Q1. C7 is typically 0.1 μF.

Maximum Suggested Gate Current

The maximum suggested gate current for the ATF-551M4 is 1 mA. Incorporating resistor R5 in the passive bias network or resistor R6 in the active bias network safely limits gate current to 500 μA at P1dB drive levels. In order to minimize component count in the passive biased amplifier circuit, the 3 resistor bias circuit consisting of R1, R2, and R5 can be simplified if desired. R5 can be removed if R1 is replaced with a 5.6kΩ resistor and if R2 is replaced with a 27kΩ resistor. This combination should limit gate current to a safe level.

ATF-551M4 Die Model

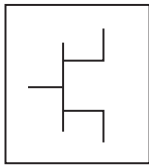

| | | | |
|-------------------------|---------------|-----------|------------|
| Advanced_Curtice2_Model | | | |
| MESFETM1 | Rf= | Crf=0.1 F | N= |
| NFET=yes | Gscap=2 | Gsfwd= | Fnc=1 MHz |
| PFET=no | Cgs=0.6193 pF | Gsrev= | R=0.08 |
| Vto=0.3 | Cgd=0.1435 pF | Gdfwd= | P=0.2 |
| Beta=0.444 | Gdcap=2 | Gdrev= | C=0.1 |
| Lambda=72e-3 | Fc=0.65 | R1= | Taumdl=no |
| Alpha=13 | Rgd=0.5 Ohm | R2= | wVgfwd= |
| Tau= | Rd=2.025 Ohm | Vbi=0.95 | wBvgs= |
| Tnom=16.85 | Rg=1.7 Ohm | Vbr= | wBvgd= |
| Idstc= | Rs=0.675 Ohm | Vjr= | wBvds= |
| Ucrit=-0.72 | Ld= | Is= | wldsmx= |
| Vgexp=1.91 | Lg=0.094 nH | Ir= | wPmax= |
| Gamds=1e-4 | Ls= | Imax= | AllParams= |
| Vtotc= | Cds=0.100 pF | Xti= | |
| Betatce= | Rc=390 Ohm | Eg= | |
| Rgs=0.5 Ohm | | | |

ATF-551M4 Minipak Model

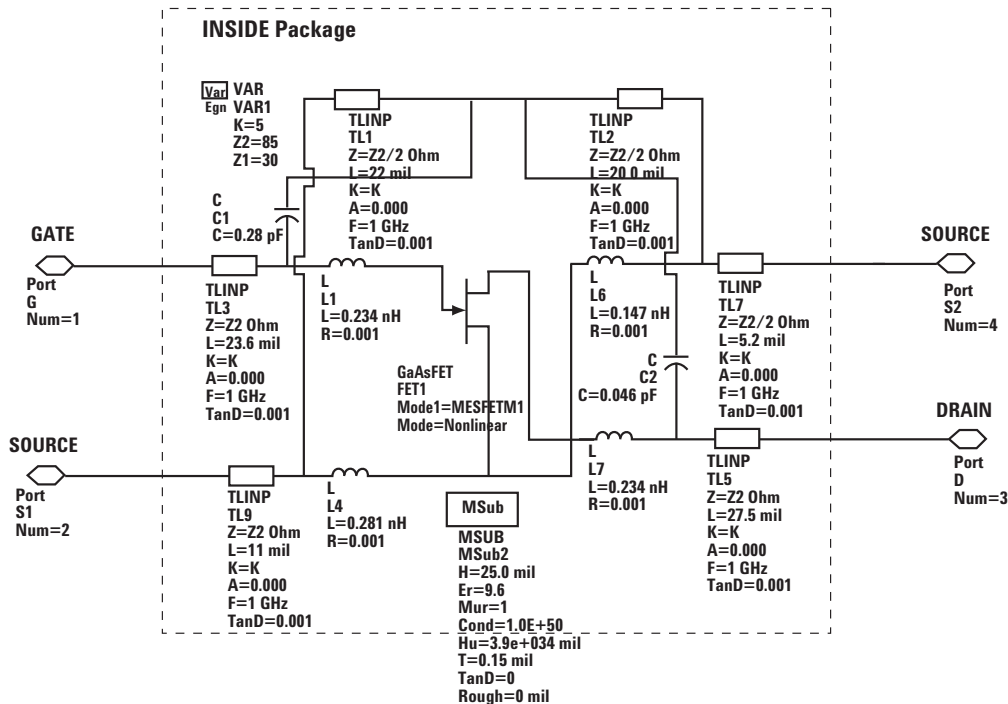

PCB Layout

A suggested PCB pad print for the miniature, Minipak 1412 package used by the ATF-551M4 is shown in Figure 39.

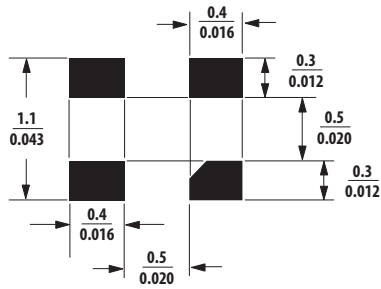

Figure 39. PCB Pad Print for Minipak 1412. Package (mm [inches]).

This pad print provides allowance for package placement by automated assembly equipment without adding excessive parasitics that could impair the high frequency performance of the ATF-551M4. The layout is shown with a footprint of the ATF-551M4 superimposed on the PCB pads for reference.

For Further Information

The information presented here is an introduction to the use of the ATF-551M4 enhancement mode PHEMT. More detailed application circuit information is available from Avago Technologies. Consult the web page or your local Avago Technologies sales representative.

Ordering Information

| Part Number | No. of Devices | Container |
|---------------|----------------|----------------|
| ATF-551M4-TR1 | 3000 | 7" Reel |
| ATF-551M4-TR2 | 10,000 | 13" Reel |
| ATF-551M4-BLK | 100 | antistatic bag |

MiniPak Package Outline Drawing

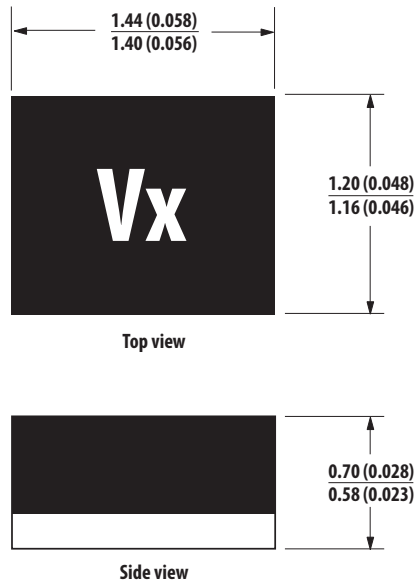

Solder Pad Dimensions

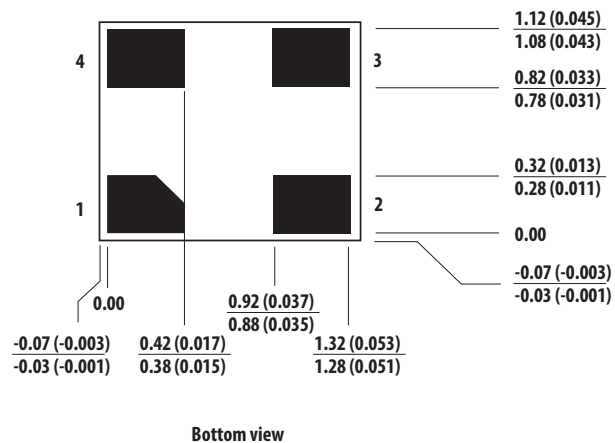

Dimensions are in millimeters (inches)

Device Orientation for Outline 4T, MiniPak 1412

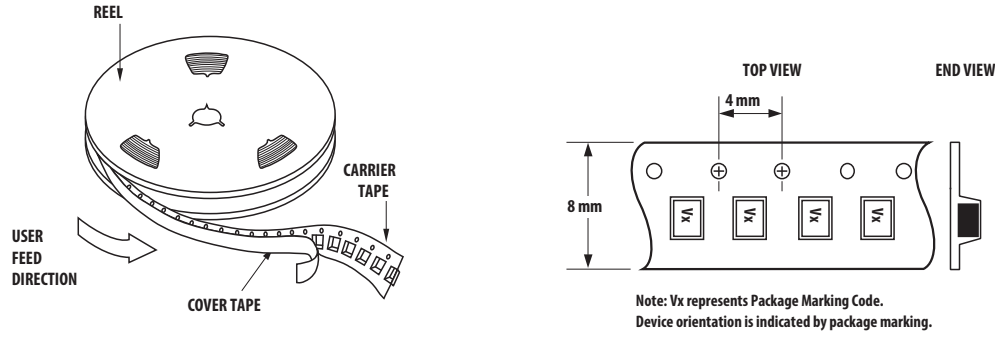

Tape Dimensions

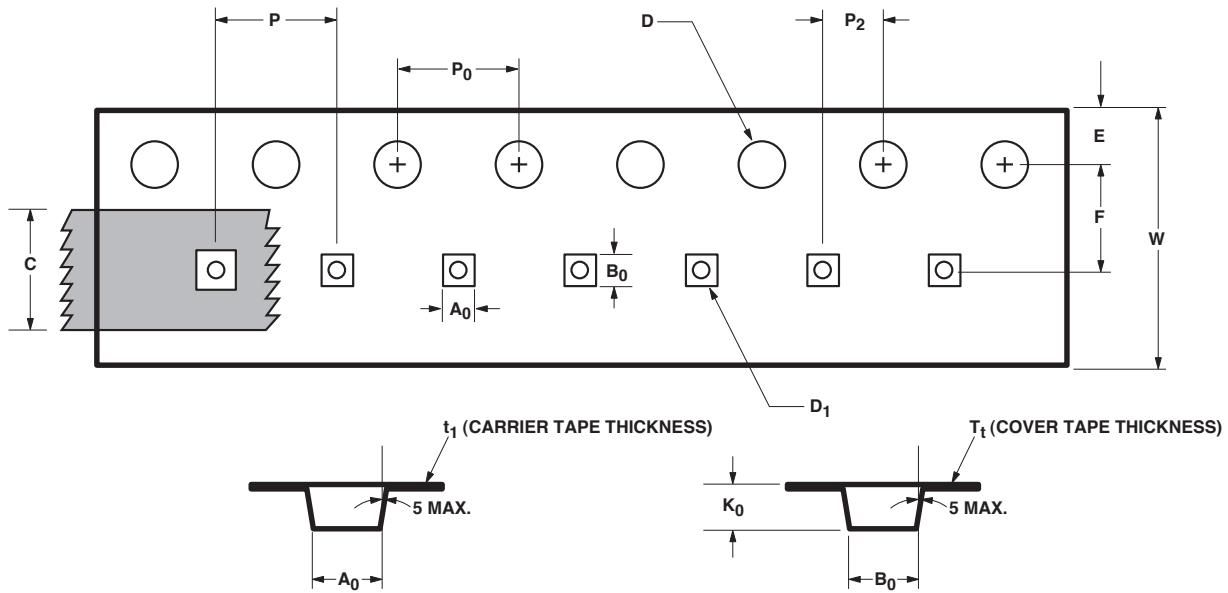

| | DESCRIPTION | SYMBOL | SIZE (mm) | SIZE (INCHES) |
|--------------|--|----------------|--------------------|-----------------------|
| CAVITY | LENGTH | A ₀ | 1.40 0.05 | 0.055 0.002 |
| | WIDTH | B ₀ | 1.53 0.05 | 0.064 0.002 |
| | DEPTH | K ₀ | 0.80 0.05 | 0.031 0.002 |
| | PITCH | P | 4.00 0.10 | 0.157 0.004 |
| | BOTTOM HOLE DIAMETER | D ₁ | 0.80 0.05 | 0.031 0.002 |
| PERFORATION | DIAMETER | D | 1.50 0.10 | 0.060 0.004 |
| | PITCH | P ₀ | 4.00 0.10 | 0.157 0.004 |
| | POSITION | E | 1.75 0.10 | 0.069 0.004 |
| CARRIER TAPE | WIDTH | W | 8.00 + 0.30 - 0.10 | 0.315 + 0.012 - 0.004 |
| | THICKNESS | t ₁ | 0.254 0.02 | 0.010 0.0008 |
| COVER TAPE | WIDTH | C | 5.40 0.10 | 0.213 0.004 |
| | TAPE THICKNESS | T _t | 0.062 0.001 | 0.0024 0.00004 |
| DISTANCE | CAVITY TO PERFORATION (WIDTH DIRECTION) | F | 3.50 0.05 | 0.138 0.002 |
| | CAVITY TO PERFORATION (LENGTH DIRECTION) | P ₂ | 2.00 0.05 | 0.079 0.002 |

For product information and a complete list of distributors, please go to our web site: www.avagotech.com

Avago, Avago Technologies, and the A logo are trademarks of Avago Technologies in the United States and other countries. Data subject to change. Copyright © 2005-2014 Avago Technologies. All rights reserved. Obsoletes 5989-4217EN AV02-0924EN - February 17, 2014



Mouser Electronics

Authorized Distributor

Click to View Pricing, Inventory, Delivery & Lifecycle Information:

[Avago Technologies:](#)

[ATF-551M4-BLK](#) [ATF-551M4-TR1](#) [ATF-551M4-TR2](#)