

# Analog Devices Welcomes Hittite Microwave Corporation

NO CONTENT ON THE ATTACHED DOCUMENT HAS CHANGED



**THIS PAGE INTENTIONALLY LEFT BLANK**

**InGaP HBT GAIN BLOCK MMIC  
AMPLIFIER, 0.7 -2.8 GHz**
**Typical Applications**

The HMC789ST89E is ideal for:

- Cellular/4G
- Fixed Wireless & WLAN
- CATV, Cable Modem & DBS
- Microwave Radio & Test Equipment
- IF & RF Applications

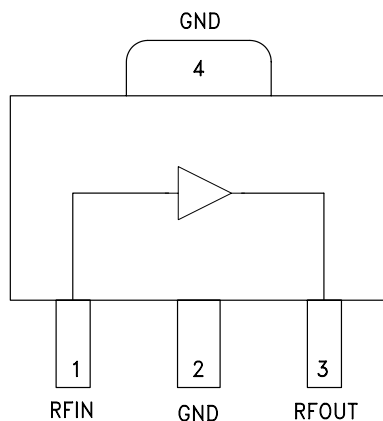
**Functional Diagram**

**Features**

- High Output IP3: +42 dBm
- High Output P1dB: +25 dBm
- High Gain: 18 dB
- Single Supply: +5V
- 45% PAE @ +25 dBm Pout
- Industry Standard SOT89 Package

**General Description**

The HMC789ST89E is a high linearity GaAs InGaP HBT gain block MMIC operating from 0.7 to 2.8 GHz and packaged in an industry standard SOT89 package. Utilizing a minimum number of external components and a single +5V supply, the amplifier output IP3 can be optimized to +45 dBm. The high output IP3 and high gain make the HMC789ST89E ideal for use in PA driver & pre-driver applications in Cellular/4G and Fixed Wireless.

**Electrical Specifications,  $T_A = +25^\circ\text{C}$ ,  $V_s = +5\text{V}$  [1]**

Parameter	Min.	Typ.	Max.	Min.	Typ.	Max.	Min.	Typ.	Max.	Units
Frequency Range	810 - 960			1710 - 1990			2420 - 2700			MHz
Gain	17	18		12	13.5		10	11		dB
Gain Variation Over Temperature		0.01			0.01			0.01		dB / °C
Input Return Loss		12			12			10		dB
Output Return Loss		20			15			10		dB
Output Power for 1dB Compression (P1dB)	21	23.5		23	25		22	24		dBm
Saturated Output Power (Psat)		25.5			27			26		dBm
Output Third Order Intercept (IP3) [2]		42			42			42		dBm
Noise Figure		3.8			3.8			3.8		dB
Supply Current (Icq)		125	150		125	150		125	150	mA

[1] Specifications and data reflect HMC789ST89E measured using the respective application circuits for each designated frequency band found herein. Contact the HMC Applications Group for assistance in optimizing performance for your application.

[2] Two-tone output power of +10 dBm per tone, 1 MHz spacing.



## InGaP HBT GAIN BLOCK MMIC AMPLIFIER, 0.7 -2.8 GHz

### Broadband Gain & Return Loss @ 900 MHz

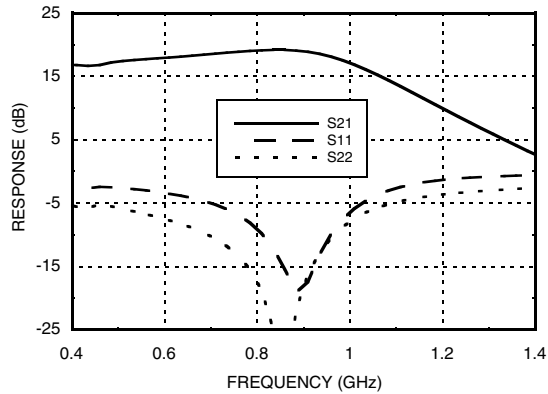

### Gain vs. Temperature @ 900 MHz

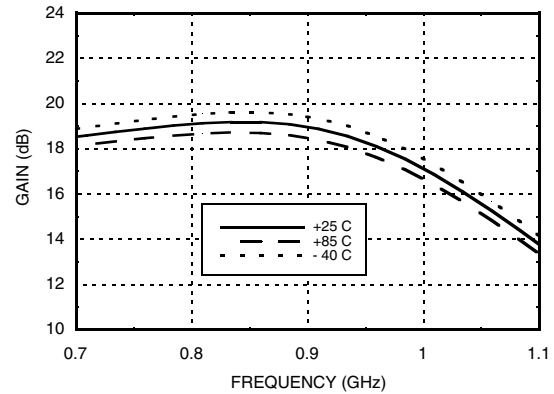

### Input Return Loss vs. Temperature @ 900 MHz

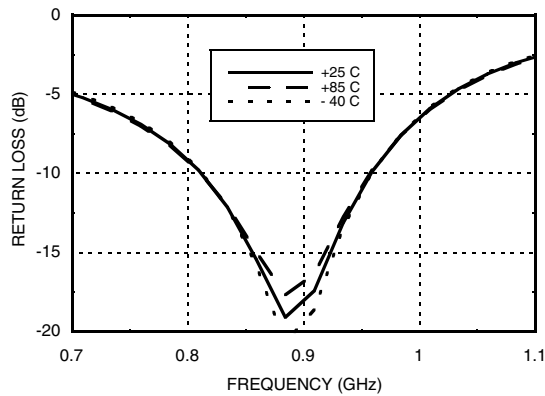

### Output Return Loss vs. Temperature @ 900 MHz

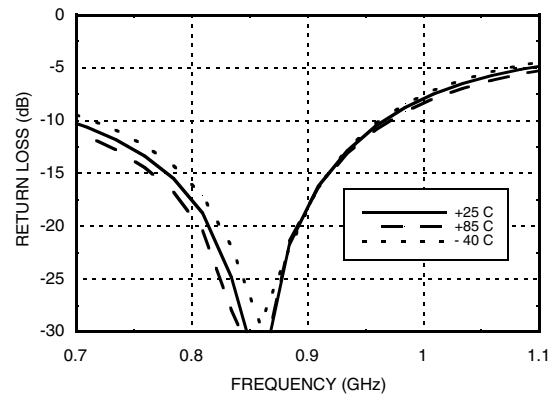

### P1dB vs. Temperature @ 900 MHz

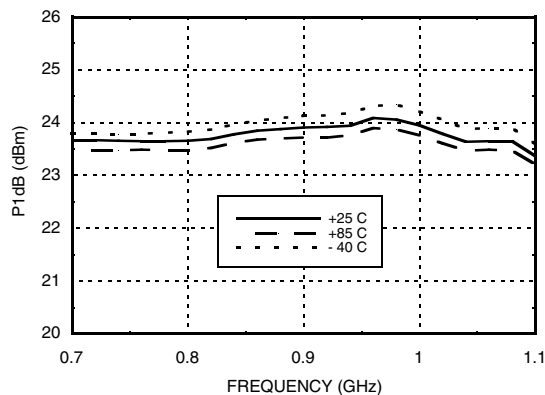

### Psat vs. Temperature @ 900 MHz

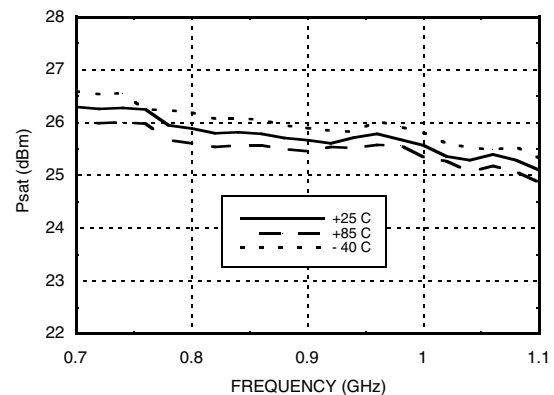



## InGaP HBT GAIN BLOCK MMIC AMPLIFIER, 0.7 -2.8 GHz

AMPLIFIERS - DRIVER & GAIN BLOCK - SMT

**Output IP3 vs. Temperature @ 900 MHz**  
Pout = 10 dBm Each Tone

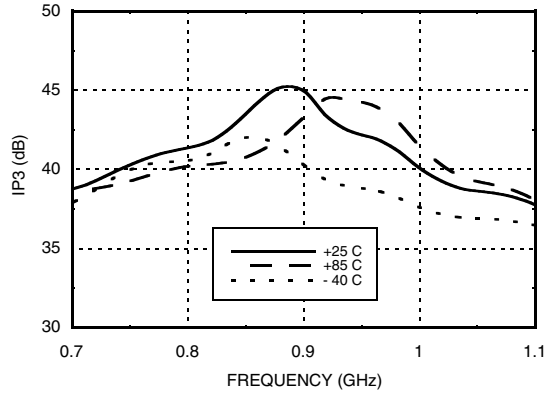

**Output IP3 vs. Output Power @ 900 MHz**

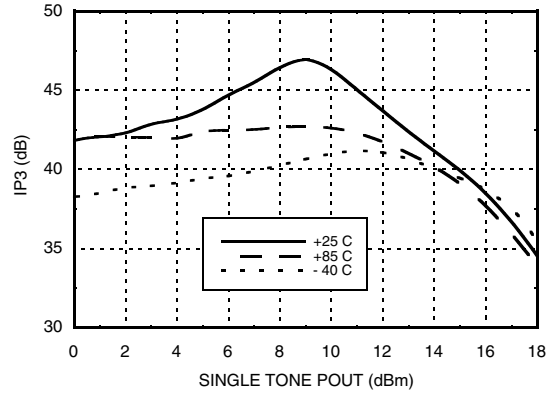

**Noise Figure vs. Temperature @ 900 MHz**

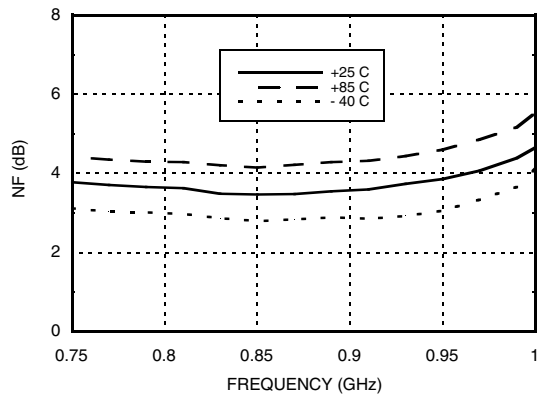

**Reverse Isolation vs. Temperature @ 900 MHz**

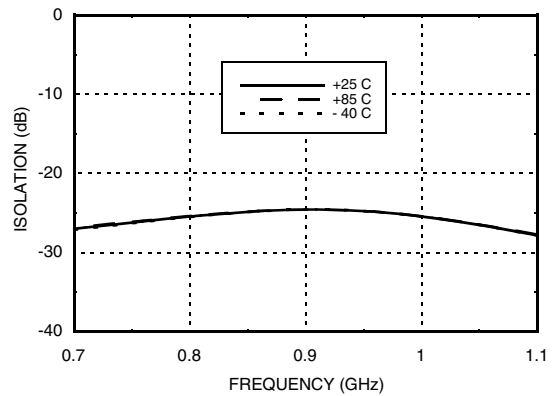

**Gain, Power & IP3 vs. Supply Voltage @ 900 MHz**

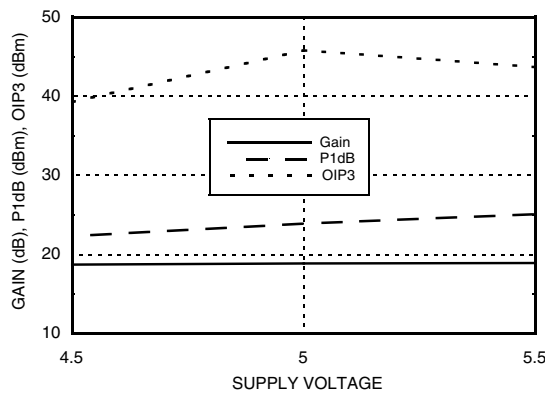

**Power Compression @ 900 MHz**

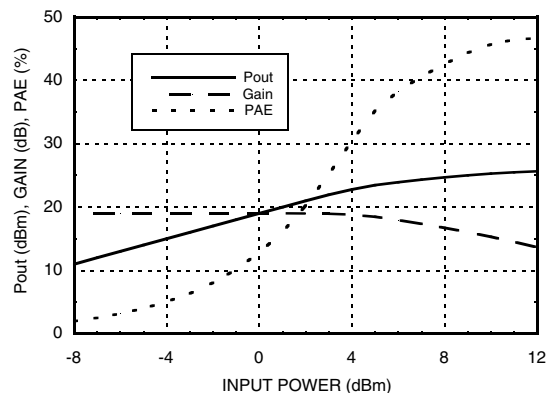



## InGaP HBT GAIN BLOCK MMIC AMPLIFIER, 0.7 -2.8 GHz

**ACPR vs. Supply Voltage @ 880 MHz  
CDMA IS95, 9 Channels Forward**

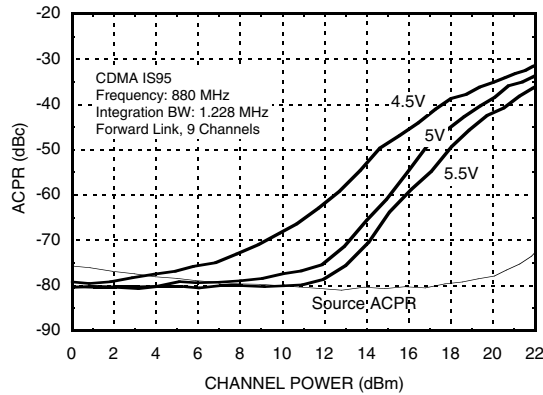

**Broadband Gain &  
Return Loss @ 1900 MHz**

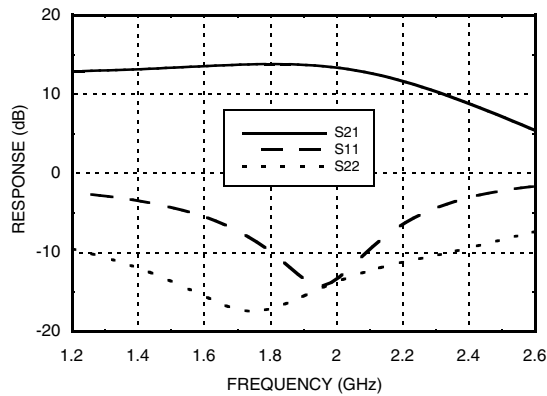

**Gain vs. Temperature @ 1900 MHz**

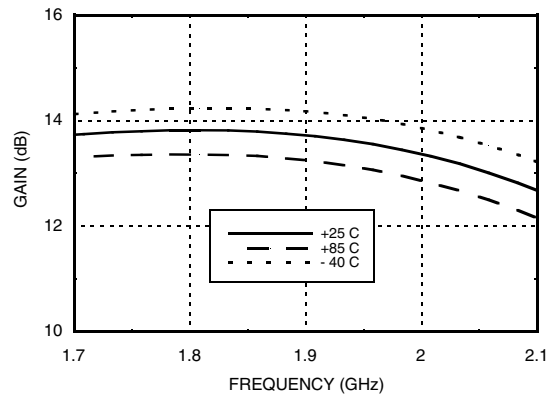

**Input Return Loss vs.  
Temperature @ 1900 MHz**

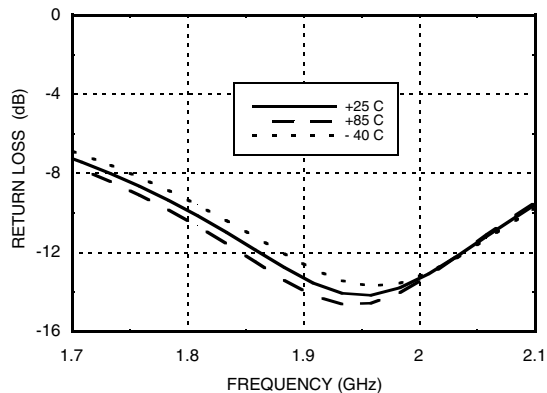

**Output Return Loss vs.  
Temperature @ 1900 MHz**

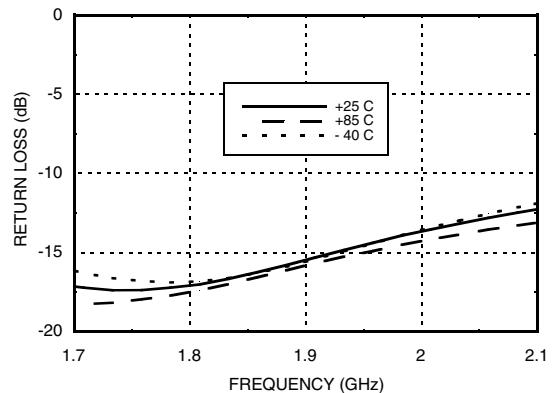

## InGaP HBT GAIN BLOCK MMIC AMPLIFIER, 0.7 -2.8 GHz

**P1dB vs. Temperature @ 1900 MHz**

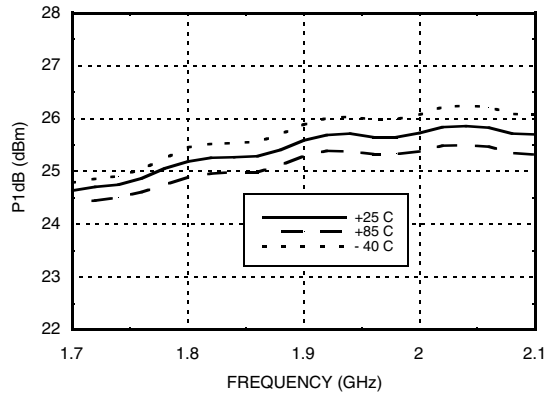

**Psat vs. Temperature @ 1900 MHz**

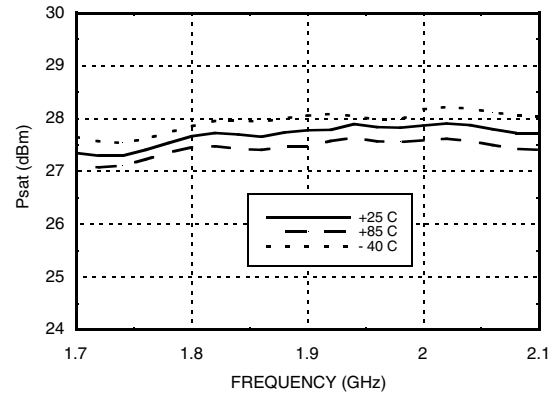

**Output IP3 vs. Temperature @ 1900 MHz**

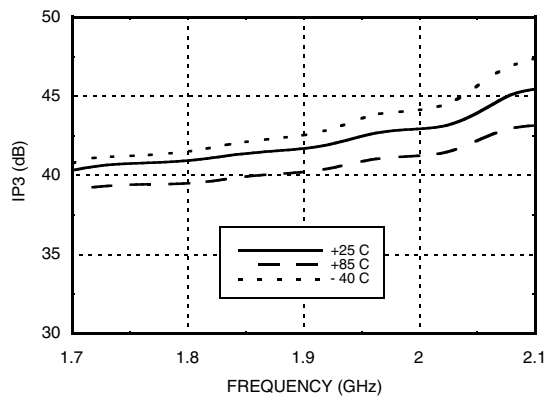

**Output IP3 vs. Output Power @ 1900 MHz**

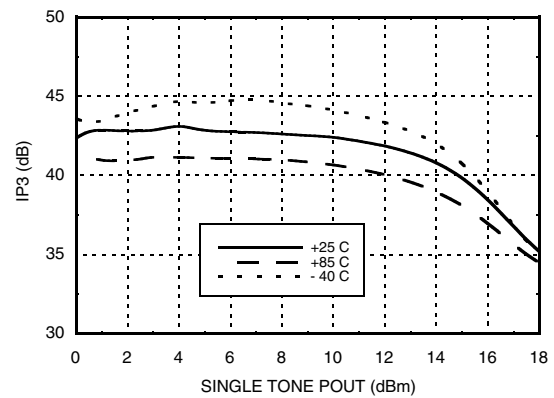

**Noise Figure vs. Temperature @ 1900 MHz**

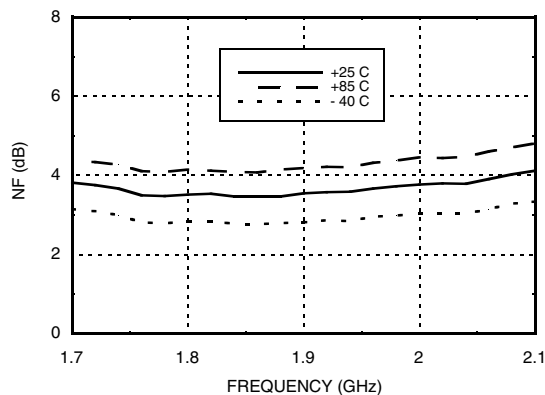

**Reverse Isolation vs. Temperature @ 1900 MHz**

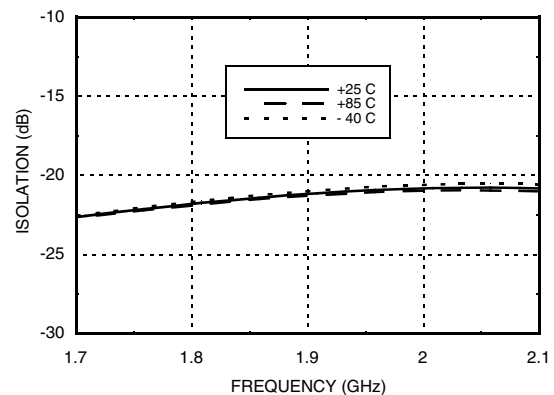



## InGaP HBT GAIN BLOCK MMIC AMPLIFIER, 0.7 -2.8 GHz

**Gain, Power & IP3 vs. Supply Voltage @ 1900 MHz**

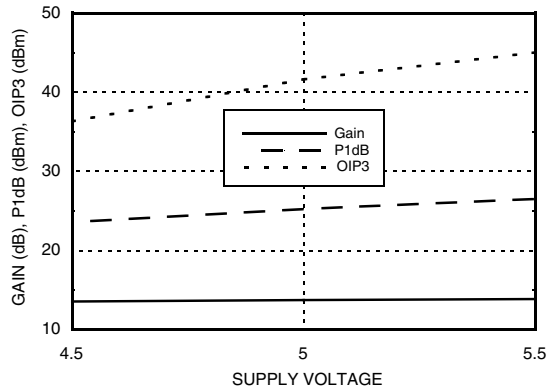

**Power Compression @ 1900 MHz**

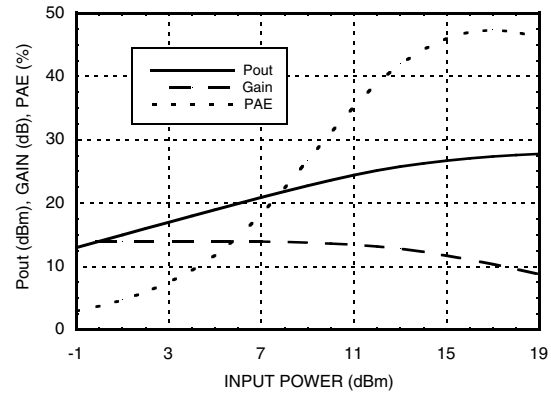

**ACPR vs. Supply Voltage @ 1960 MHz CDMA 2000, 9 Channels Forward**

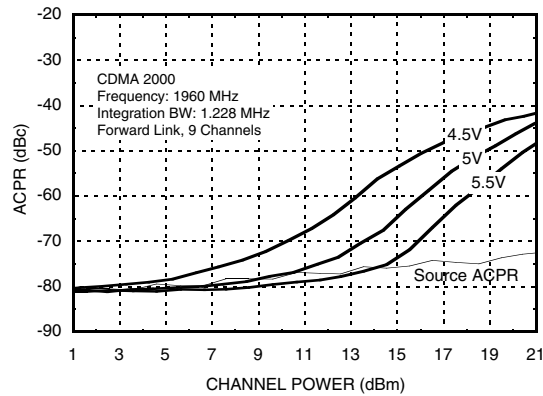

**ACPR vs. Supply Voltage @ 2140 MHz W-CDMA, 64 DPCH**

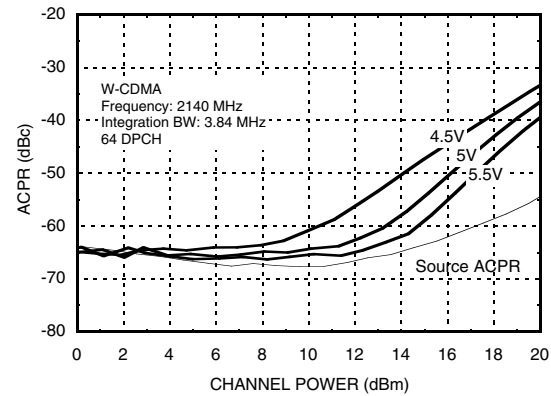

**Broadband Gain & Return Loss @ 2600 MHz**

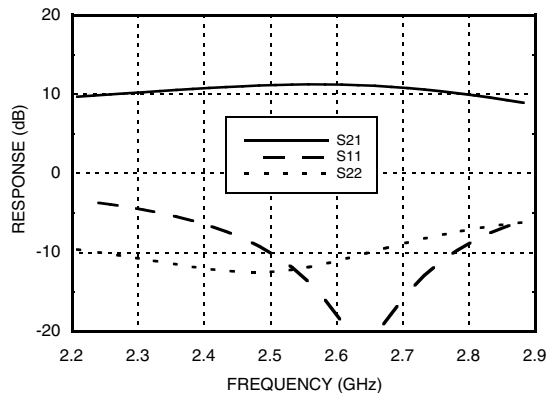

**Gain vs. Temperature @ 2600 MHz**

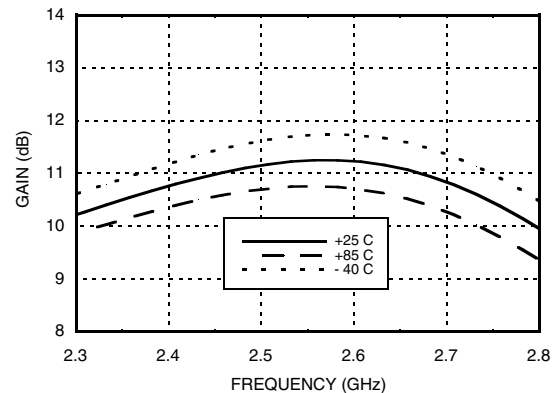





## InGaP HBT GAIN BLOCK MMIC AMPLIFIER, 0.7 -2.8 GHz

**Input Return Loss vs.  
Temperature @ 2600 MHz**

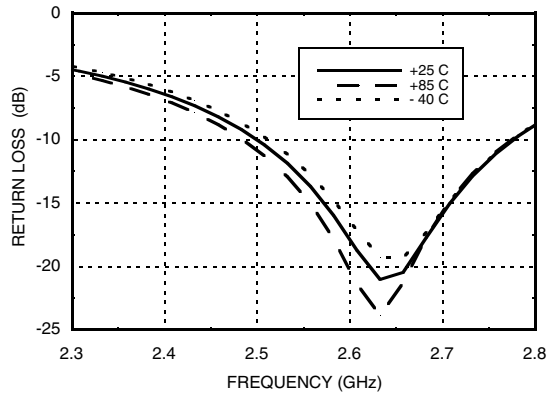

**Output Return Loss vs.  
Temperature @ 2600 MHz**

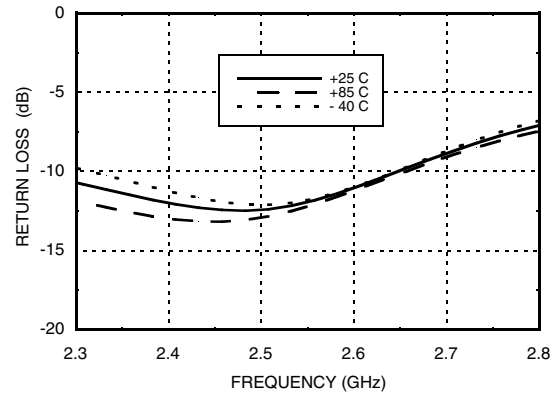

**P1dB vs. Temperature @ 2600 MHz**

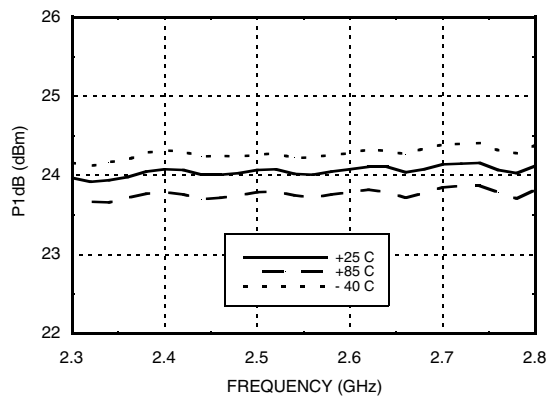

**Psat vs. Temperature @ 2600 MHz**

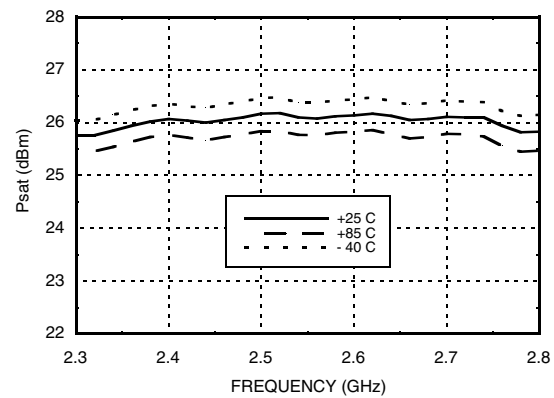

**Output IP3 vs. Temperature @ 2600 MHz**

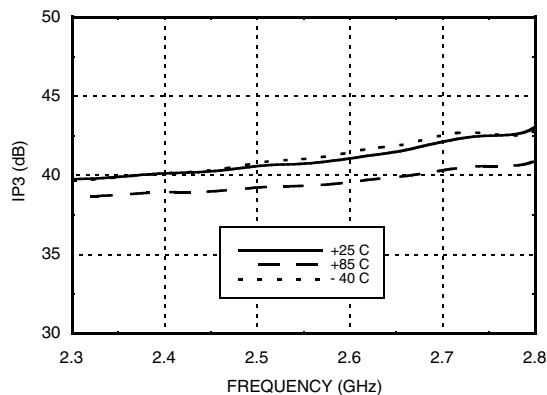

**Output IP3 vs. Output Power @ 2600 MHz**

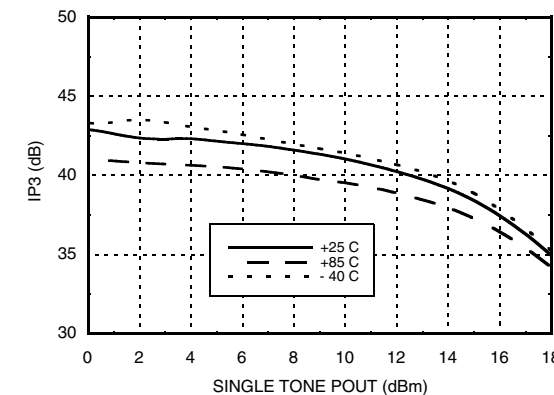

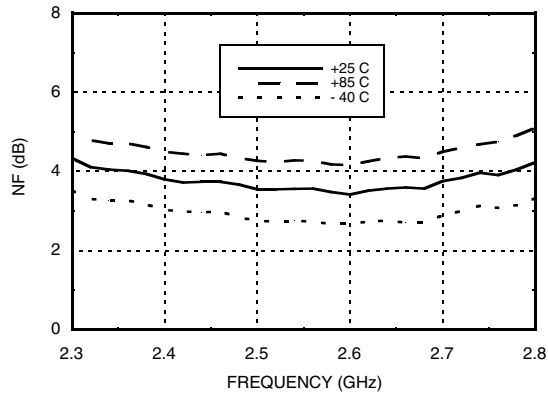
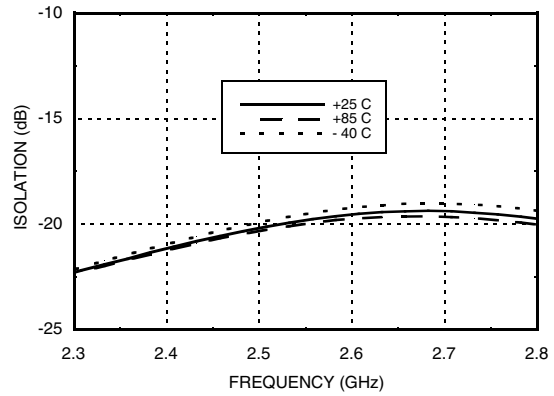
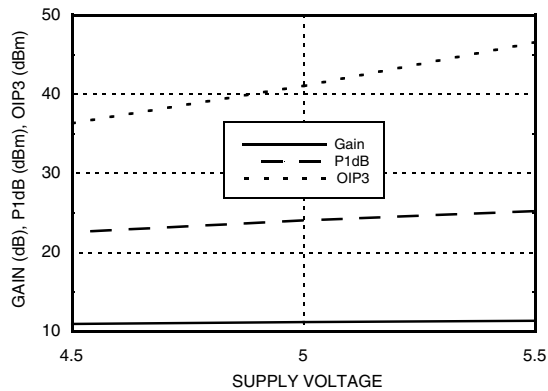
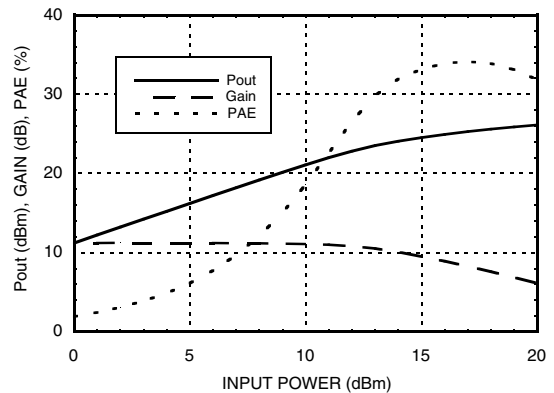

**InGaP HBT GAIN BLOCK MMIC  
AMPLIFIER, 0.7 -2.8 GHz**
**Noise Figure vs. Temperature @ 2600 MHz**

**Reverse Isolation vs. Temperature @ 2600 MHz**

**Gain, Power & IP3 vs. Supply Voltage @ 2600 MHz**

**Power Compression @ 2600 MHz**

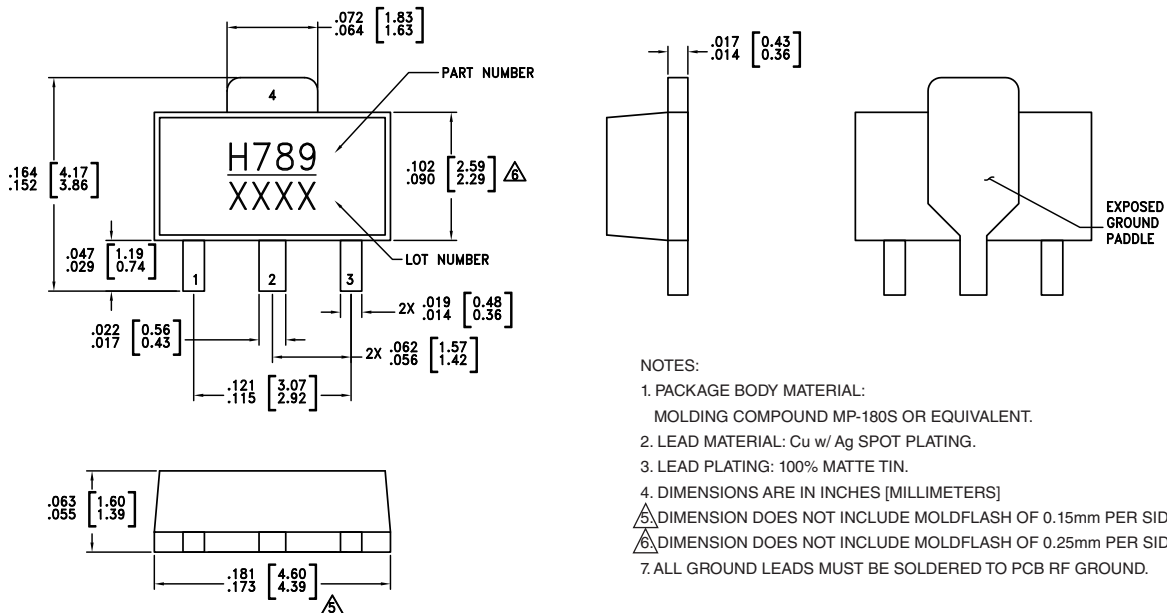
**Absolute Maximum Ratings**

Collector Bias Voltage (Vcc)	+6.0 V
RF Input Power (RFIN)(Vs +5Vdc)	+18 dBm
Junction Temperature	150 °C
Continuous Pdiss (T = 85 °C) (derate 13.0 mW/°C above 85 °C)	0.85 W
Thermal Resistance (junction to ground paddle)	77 °C/W
Storage Temperature	-65 to +150 °C
Operating Temperature	-40 to +85 °C



**ELECTROSTATIC SENSITIVE DEVICE  
OBSERVE HANDLING PRECAUTIONS**

**Outline Drawing**

**NOTES:**

- PACKAGE BODY MATERIAL:  
MOLDING COMPOUND MP-180S OR EQUIVALENT.
- LEAD MATERIAL: Cu w/ Ag SPOT PLATING.
- LEAD PLATING: 100% MATTE TIN.
- DIMENSIONS ARE IN INCHES [MILLIMETERS]
- $\Delta$  DIMENSION DOES NOT INCLUDE MOLDFLASH OF 0.15mm PER SIDE.
- $\Delta$  DIMENSION DOES NOT INCLUDE MOLDFLASH OF 0.25mm PER SIDE.
- ALL GROUND LEADS MUST BE SOLDERED TO PCB RF GROUND.



**Package Information**

Part Number	Package Body Material	Lead Finish	MSL Rating	Package Marking <sup>[1]</sup>
HMC789ST89E	RoHS-compliant Low Stress Injection Molded Plastic	100% matte Sn	MSL1 <sup>[2]</sup>	H789 XXXX

[1] 4-Digit lot number XXXX

[2] Max peak reflow temperature of 260 °C

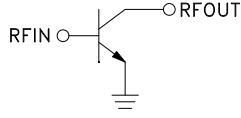
**Pin Descriptions**

Pin Number	Function	Description	Interface Schematic
1	RFIN	This pin is DC coupled. Off chip matching components are required. See Application Circuit herein.	
3	RFOUT	RF output and DC Bias input for the amplifier. Off chip matching components are required. See Application Circuit herein.	
2, 4	GND	These pins & package bottom must be connected to RF/DC ground.	

**900 MHz Application Circuit**

This circuit was used to specify the performance for 810-960 MHz operation. Contact the HMC Applications Group for assistance in optimizing performance for your application.

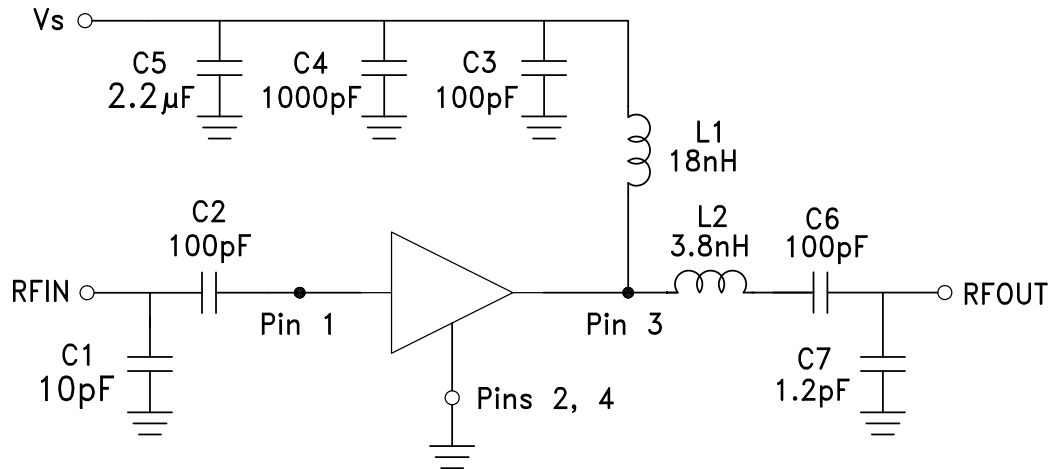

Recommended Component Values	
C1	10 pF
C2	100 pF
C3	100 pF
C4	1000 pF
C5	2.2 μF
C6	100 pF
C7	1.2 pF
L1	18 nH
L2	3.8 nH

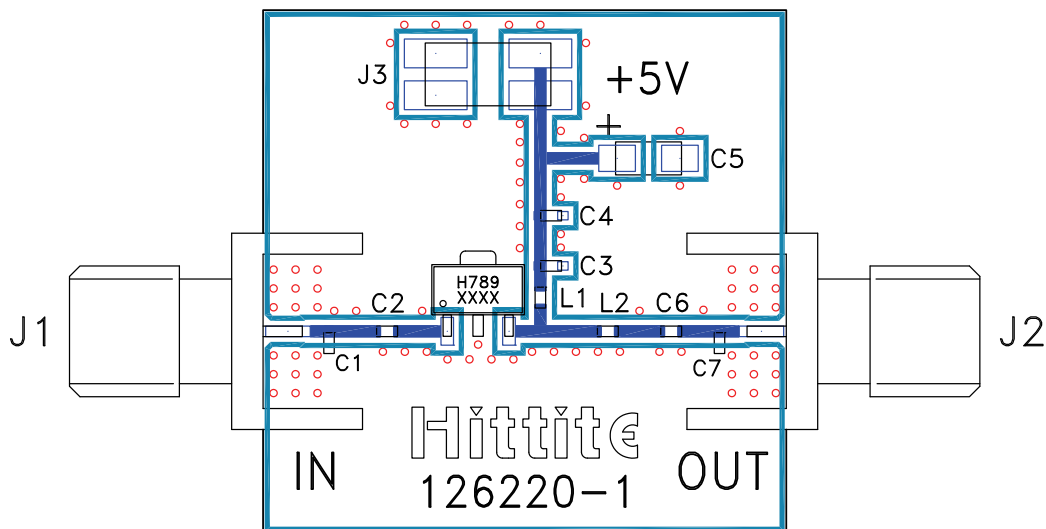
**900 MHz Evaluation PCB**

**List of Materials for 900 MHz Evaluation PCB 126222 [1]**

Item	Description
J1 - J2	PCB Mount SMA Connector
J3	2 mm DC Header
C1	10 pF Capacitor, 0402 Pkg.
C2	100 pF Capacitor, 0402 Pkg.
C3	100 pF Capacitor, 0402 Pkg.
C4	1000 pF Capacitor, 0402 Pkg.
C5	2.2 $\mu$ F Capacitor, Tantalum
C6	100 pF Capacitor, 0402 Pkg.
C7	1.2 pF Capacitor, 0402 Pkg.
L1	18 nH Inductor, 0402 Pkg.
L2	3.8 nH Inductor, 0402 Pkg.
U1	HMC789ST89E Linear Amplifier
PCB [2]	126220 Evaluation PCB

[1] Reference this number when ordering complete evaluation PCB

[2] Circuit Board Material: FR4

The circuit board used in this application should use RF circuit design techniques. Signal lines should have 50 Ohm impedance while the package ground leads and exposed paddle should be connected directly to the ground plane similar to that shown. A sufficient number of via holes should be used to connect the top and bottom ground planes. The evaluation board should be mounted to an appropriate heat sink. The evaluation circuit board shown is available from Hittite upon request.

**1900 MHz Application Circuit**

This circuit was used to specify the performance for 1710-1990 MHz operation. Contact the HMC Applications Group for assistance in optimizing performance for your application.

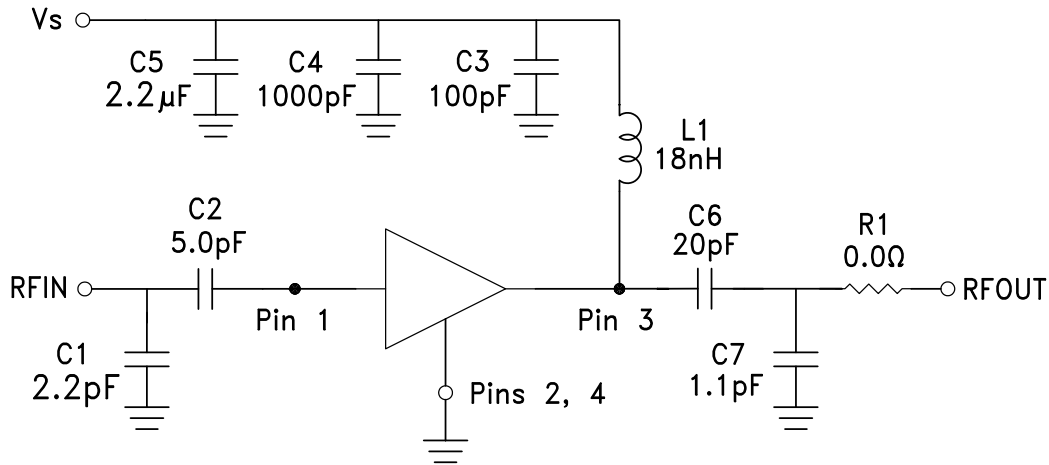

Recommended Component Values	
C1	2.2 pF
C2	5.0 pF
C3	100 pF
C4	1000 pF
C5	2.2 μF
C6	20 pF
C7	1.1 pF
L1	20 nH
R1	0.0 Ohm

### 1900 MHz Evaluation PCB

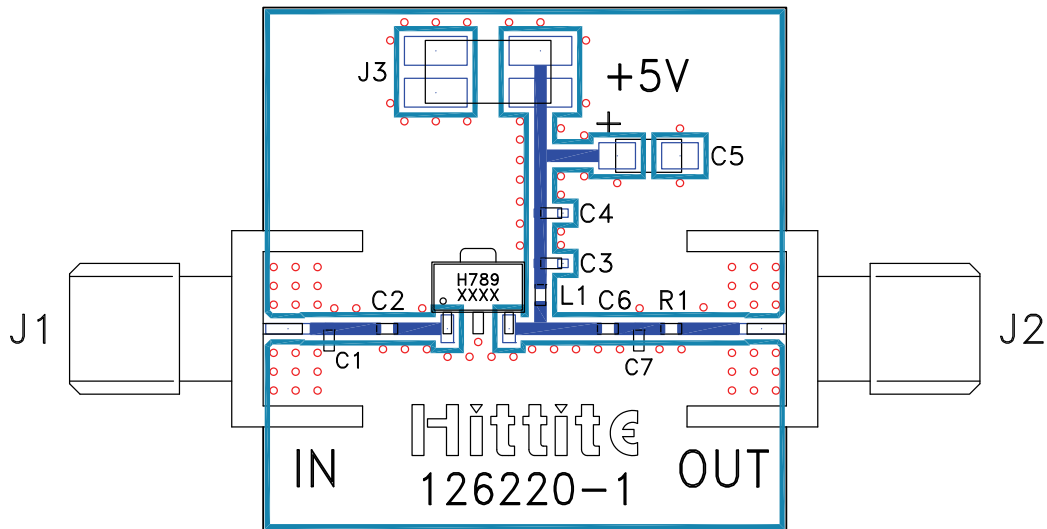

### List of Materials for 1900 MHz Evaluation PCB 126223 [1]

Item	Description
J1 - J2	PCB Mount SMA Connector
J3	2 mm DC Header
C1	2.2 pF Capacitor, 0402 Pkg.
C2	5.0 pF Capacitor, 0402 Pkg.
C3	100 pF Capacitor, 0402 Pkg.
C4	1000 pF Capacitor, 0402 Pkg.
C5	2.2 μF Capacitor, Tantalum
C6	20 pF Capacitor, 0402 Pkg.
C7	1.1 pF Capacitor, 0402 Pkg.
L1	18 nH Inductor, 0402 Pkg.
R1	0.0 Ohm Resistor, 0402 Pkg.
U1	HMC789ST89E Linear Amplifier
PCB [2]	126220 Evaluation PCB

[1] Reference this number when ordering complete evaluation PCB

[2] Circuit Board Material: FR4

The circuit board used in this application should use RF circuit design techniques. Signal lines should have 50 Ohm impedance while the package ground leads and exposed paddle should be connected directly to the ground plane similar to that shown. A sufficient number of via holes should be used to connect the top and bottom ground planes. The evaluation board should be mounted to an appropriate heat sink. The evaluation circuit board shown is available from Hittite upon request.



**2600 MHz Application Circuit**

This circuit was used to specify the performance for 2420-2700 MHz operation. Contact the HMC Applications Group for assistance in optimizing performance for your application.

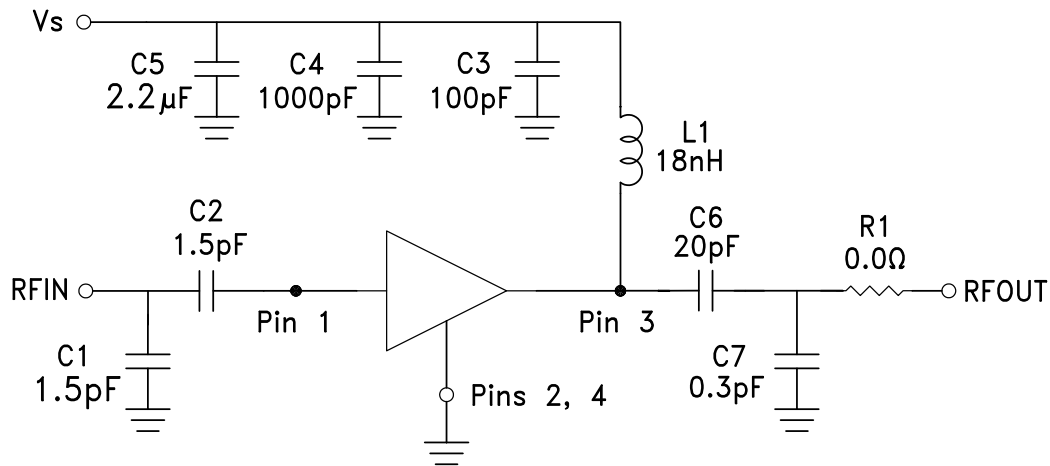

Recommended Component Values	
C1	1.5 pF
C2	1.5 pF
C3	100 pF
C4	1000 pF
C5	2.2 μF
C6	20 pF
C7	0.3 pF
L1	18 nH
L2	12 nH
R1	0.0 Ohm

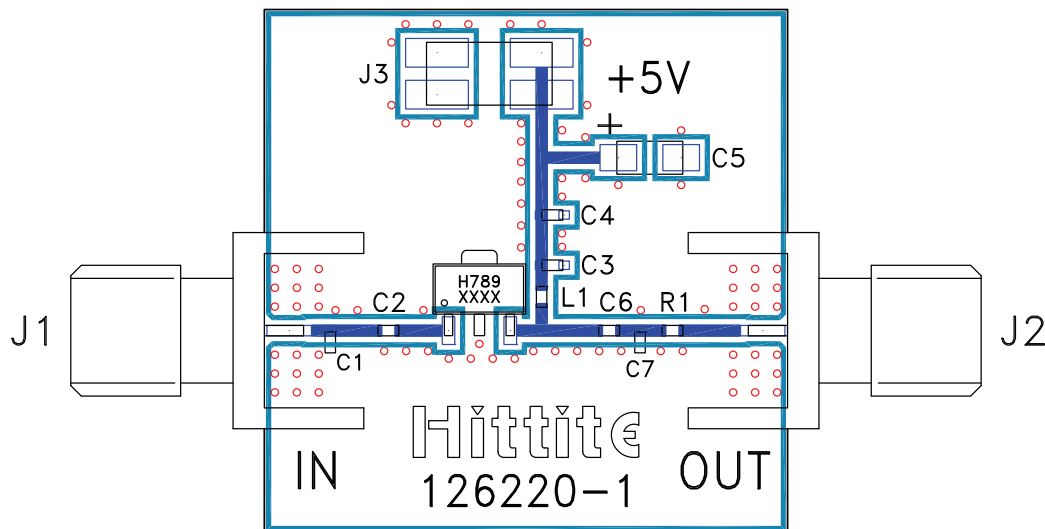
**2600 MHz Evaluation PCB**

**List of Materials for 2600 MHz Evaluation PCB 125682 [1]**

Item	Description
J1 - J2	PCB Mount SMA Connector
J3	2 mm DC Header
C1	1.5 pF Capacitor, 0402 Pkg.
C2	1.5 pF Capacitor, 0402 Pkg.
C3	100 pF Capacitor, 0402 Pkg.
C4	1000 pF Capacitor, 0402 Pkg.
C5	2.2 $\mu$ F Capacitor, Tantalum
C6	20 pF Capacitor, 0402 Pkg.
C7	0.3 pF Capacitor, 0402 Pkg.
L1	18 nH Inductor, 0402 Pkg.
R1	0.0 Ohm Resistor, 0402 Pkg.
U1	HMC789ST89E Linear Amplifier
PCB [2]	125220 Evaluation PCB

[1] Reference this number when ordering complete evaluation PCB

[2] Circuit Board Material: FR4

The circuit board used in this application should use RF circuit design techniques. Signal lines should have 50 Ohm impedance while the package ground leads and exposed paddle should be connected directly to the ground plane similar to that shown. A sufficient number of via holes should be used to connect the top and bottom ground planes. The evaluation board should be mounted to an appropriate heat sink. The evaluation circuit board shown is available from Hittite upon request.

# Mouser Electronics

Authorized Distributor

Click to View Pricing, Inventory, Delivery & Lifecycle Information:

[Analog Devices Inc.:](#)

[HMC789ST89E](#) [HMC789ST89ETR](#) [125682-HMC789ST89E](#) [126222-HMC789ST89E](#) [126223-HMC789ST89E](#)