

Analog Devices Welcomes Hittite Microwave Corporation

NO CONTENT ON THE ATTACHED DOCUMENT HAS CHANGED



THIS PAGE INTENTIONALLY LEFT BLANK

Typical Applications

The HMC7357LP5GE is ideal for:

- Point-to-Point Radios
- Point-to-Multi-Point Radios
- VSAT & SATCOM

Features

- +35 dBm Pout @ 34% PAE
- High P1dB Output Power: +34 dBm
- High Output IP3: +41.5 dBm
- High Gain: 29 dB
- 50 Ohm Matched Input/Output
- Supply Voltage: Vdd = +8V @ 1200 mA
- 24-Lead 5x5 mm SMT Package

Functional Diagram

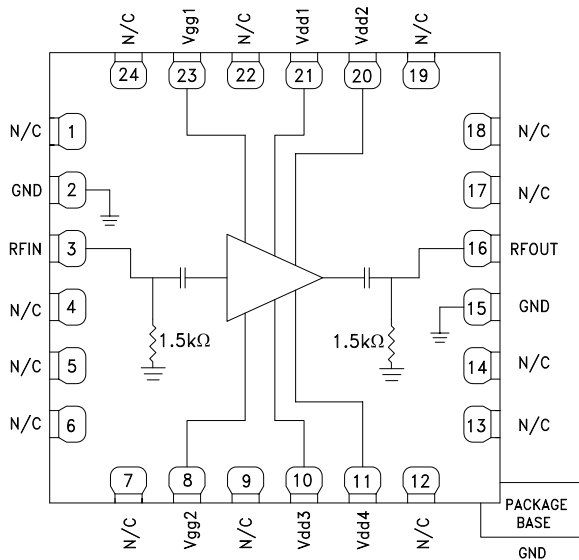

General Description

The HMC7357LP5GE is a three-stage GaAs pHEMT MMIC Medium Power Amplifier that operates between 5.5 and 8.5 GHz. The amplifier provides 29 dB of gain and +35 dBm of saturated output power at 34% PAE from a +8V supply. With an excellent Output IP3 of +41.5 dBm, the HMC7357LP5GE is ideal for linear applications such as high capacity point-to-point and point-to-multi-point radios or VSAT/SATCOM applications demanding +35 dBm of efficient saturated output power. The RF I/Os are internally matched to 50 Ohms for ease of use. The HMC7357LP5GE is packaged in a leadless 5x5 mm plastic surface mount package and is compatible with surface mount manufacturing techniques.

Electrical Specifications, $T_A = +25^\circ\text{C}$

$V_{dd1} = V_{dd2} = V_{dd3} = V_{dd4} = 8\text{V}$, $I_{dd} = 1200\text{ mA}$ [1]

Parameter	Min.	Typ.	Max.	Min.	Typ.	Max.	Units
Frequency Range	5.5 - 7		7 - 8.5				GHz
Gain	26.5	29.5		28	31		dB
Gain Variation Over Temperature	0.0214		0.0234				dB/ °C
Input Return Loss	14		14				dB
Output Return Loss	22		15				dB
Output Power for 1 dB Compression (P1dB)	31.5	34.5		31.5	34.5		dBm
Saturated Output Power (P _{sat})	35		35				dBm
Output Third Order Intercept (IP3) ^[2]	41.5		41.5				dBm
Total Supply Current (I _{dd})	1200		1200				mA

[1] Adjust V_{gg} between -2 to -0.4V to achieve I_{dd} = 1200 mA typical.

[2] Measurement taken at +8V @ 1200 mA, P_{out} / Tone = +20 dBm



**GaAs pHEMT MMIC 2 WATT
POWER AMPLIFIER, 5.5 - 8.5 GHz**

Gain & Return Loss

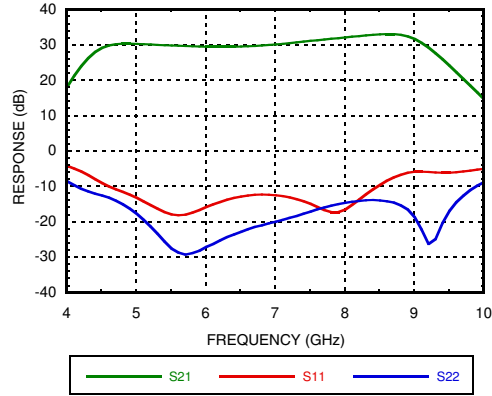

Gain vs. Temperature

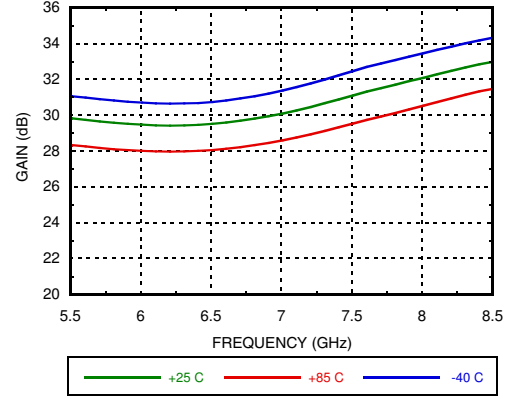

Input Return Loss vs. Temperature

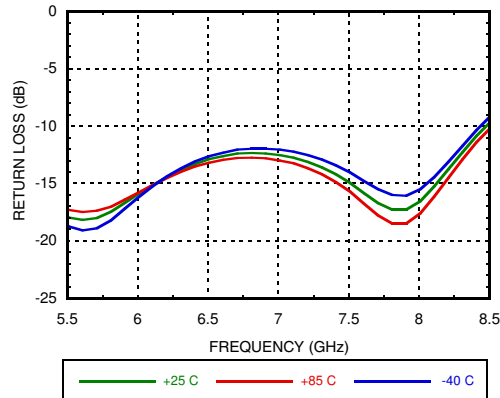

Output Return Loss vs. Temperature

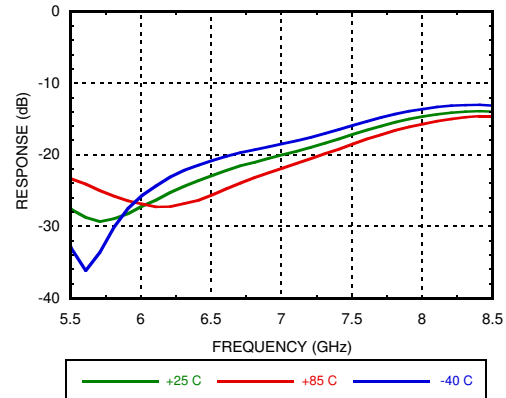

P1dB vs. Temperature

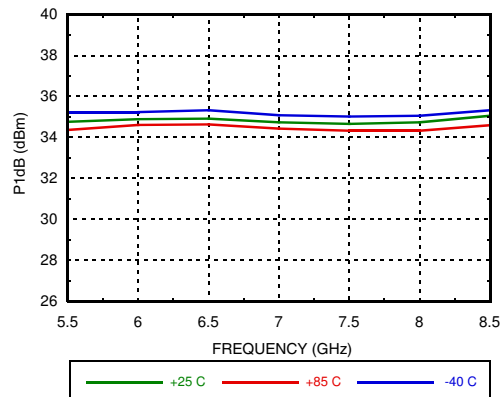

P1dB vs. Supply Voltage

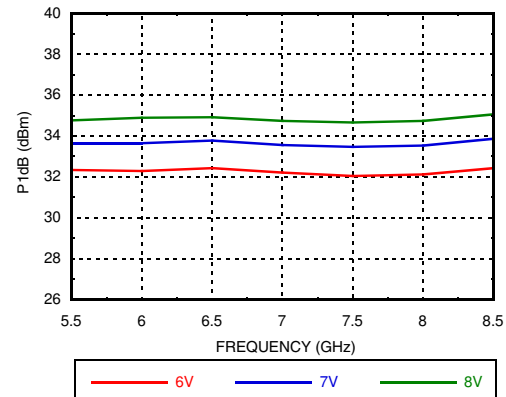



GaAs pHEMT MMIC 2 WATT POWER AMPLIFIER, 5.5 - 8.5 GHz

Psat vs. Temperature

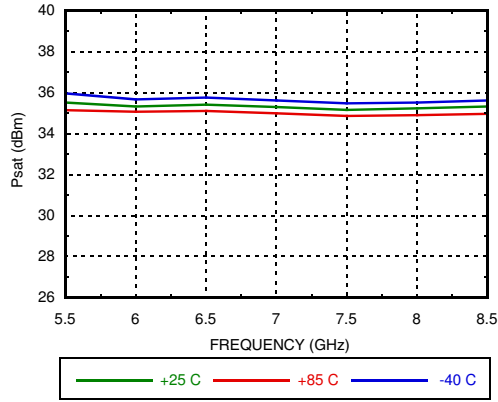

Psat vs. Supply Voltage

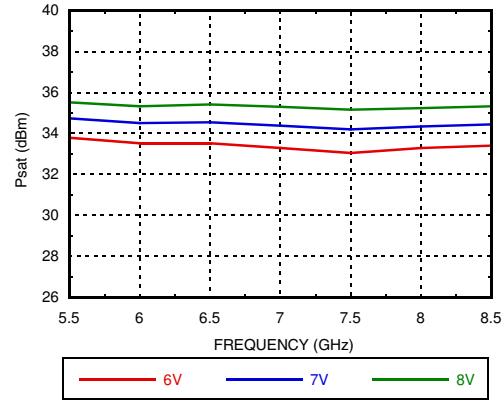

P1dB vs. Supply Current

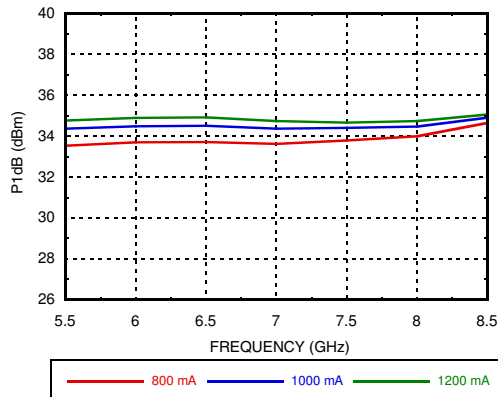

Psat vs. Supply Current

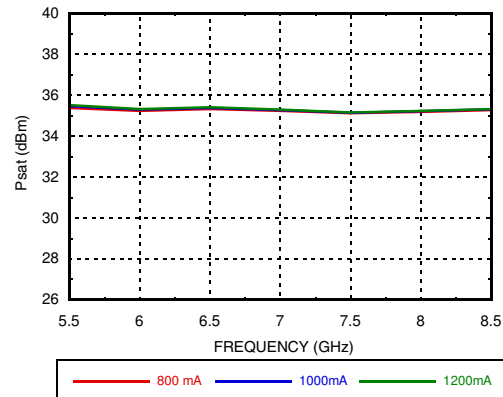

**Output IP3 vs. Temperature,
Pout/tone = +20 dBm**

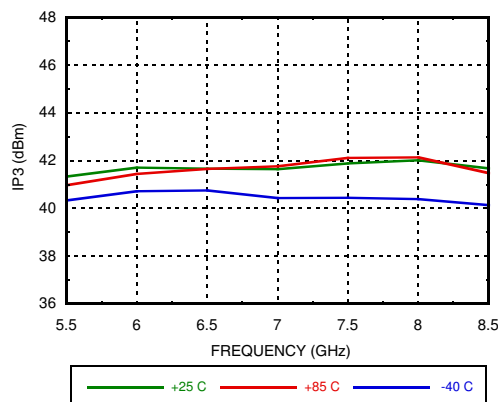

**Output IP3 vs. Supply Current,
Pout/tone = +20 dBm**

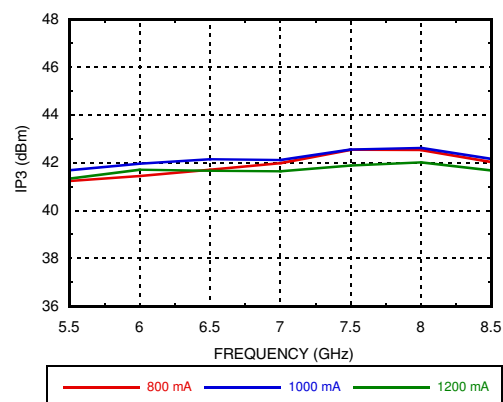



GaAs pHEMT MMIC 2 WATT POWER AMPLIFIER, 5.5 - 8.5 GHz

**Output IP3 vs. Supply Voltage,
Pout/tone = +20 dBm**

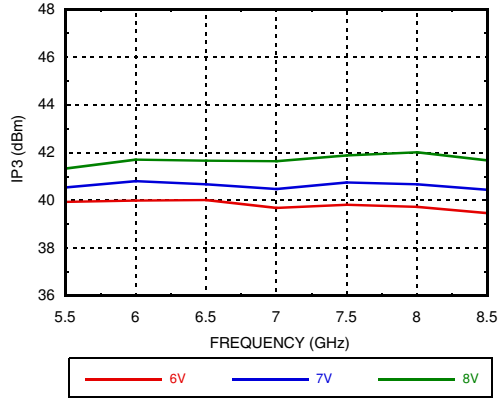

Output IM3 @ Vdd = +6V

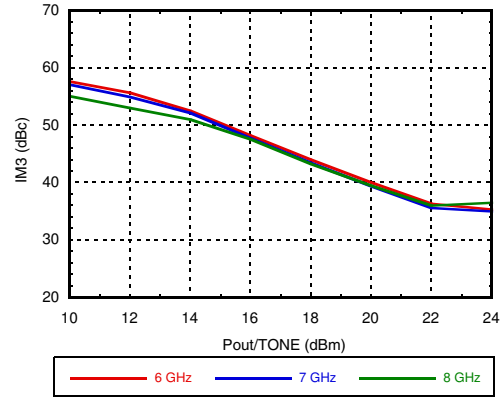

Output IM3 @ Vdd = +7V

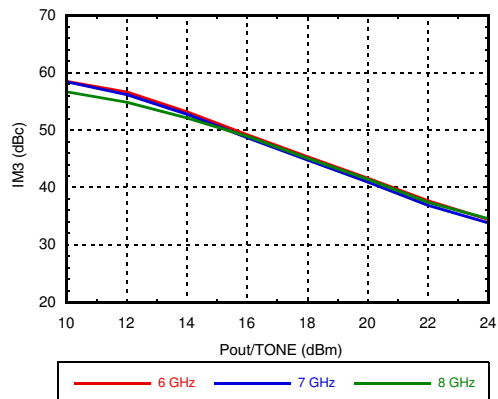

Output IM3 @ Vdd = +8V

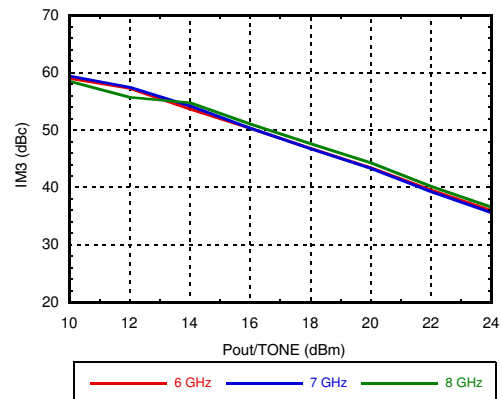

Power Compression @ 6 GHz

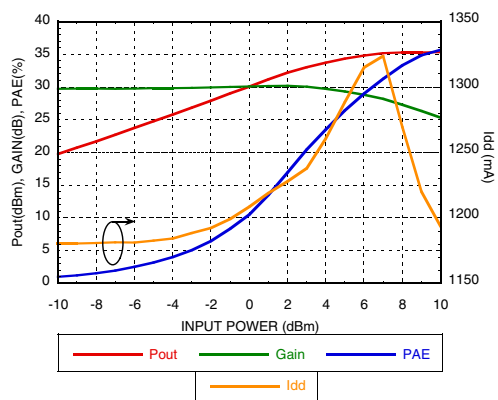

Power Compression @ 7 GHz

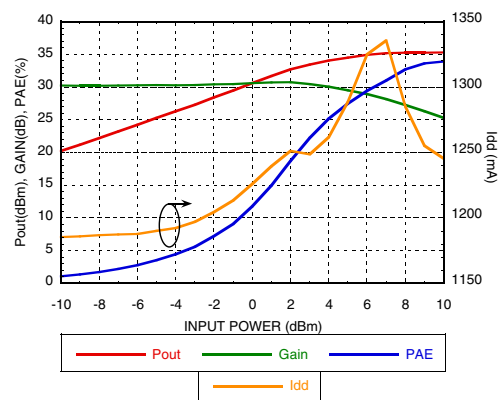



GaAs pHEMT MMIC 2 WATT POWER AMPLIFIER, 5.5 - 8.5 GHz

Power Compression @ 8 GHz

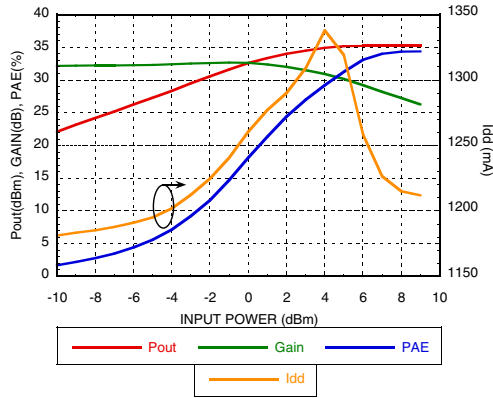

Reverse Isolation vs. Temperature

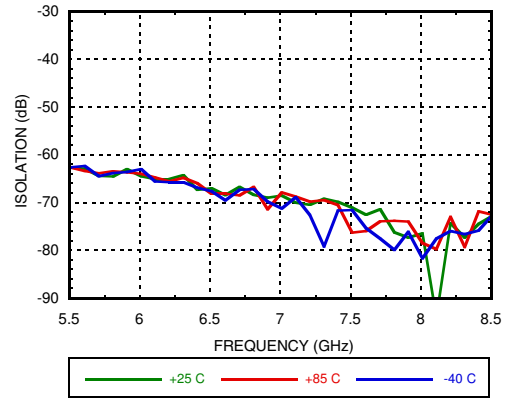

Gain & Power vs. Supply Current @ 7 GHz

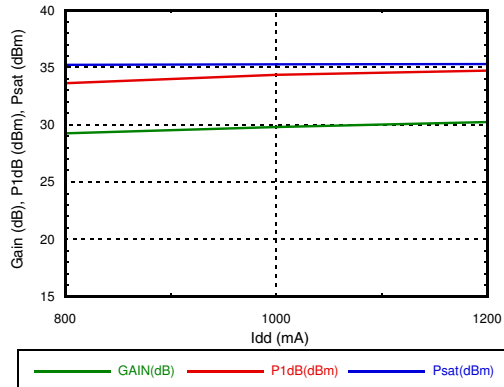

Gain & Power vs. Supply Voltage @ 7 GHz

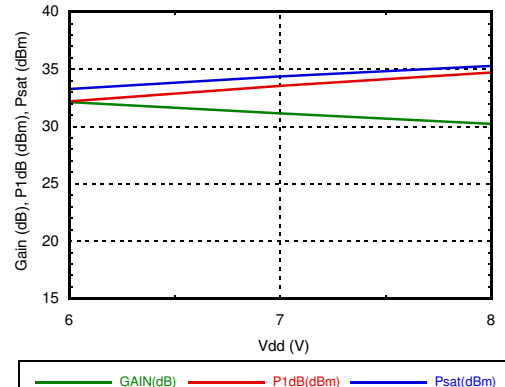

Power Dissipation

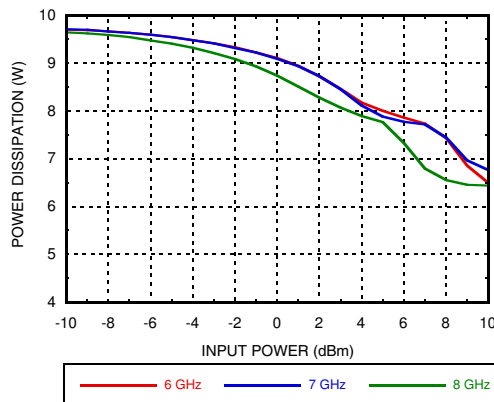

GaAs pHEMT MMIC 2 WATT POWER AMPLIFIER, 5.5 - 8.5 GHz

Absolute Maximum Ratings

Drain Bias Voltage (Vdd)	+9 Vdc
Gate Bias Voltage (Vgg)	-2 to -0.4 Vdc
RF Input Power (RFIN)	+22 dBm
Channel Temperature	175 °C
Continuous Pdiss (T= 85 °C) (derate 133mW/°C above 85 °C)	12.6 W
Thermal Resistance (channel to ground paddle)	7.5 °C/W
Storage Temperature	-65 to 150°C
Operating Temperature	-40 to 85 °C
ESD Sensitivity (HBM)	Class 1A, passed 250V

Typical Supply Current vs. Vdd

Vdd (V)	Idd (mA)
+6	1200
+7	1200
+8	1200

Adjust Vgg to achieve Idd = 1200 mA



**ELECTROSTATIC SENSITIVE DEVICE
OBSERVE HANDLING PRECAUTIONS**

Outline Drawing

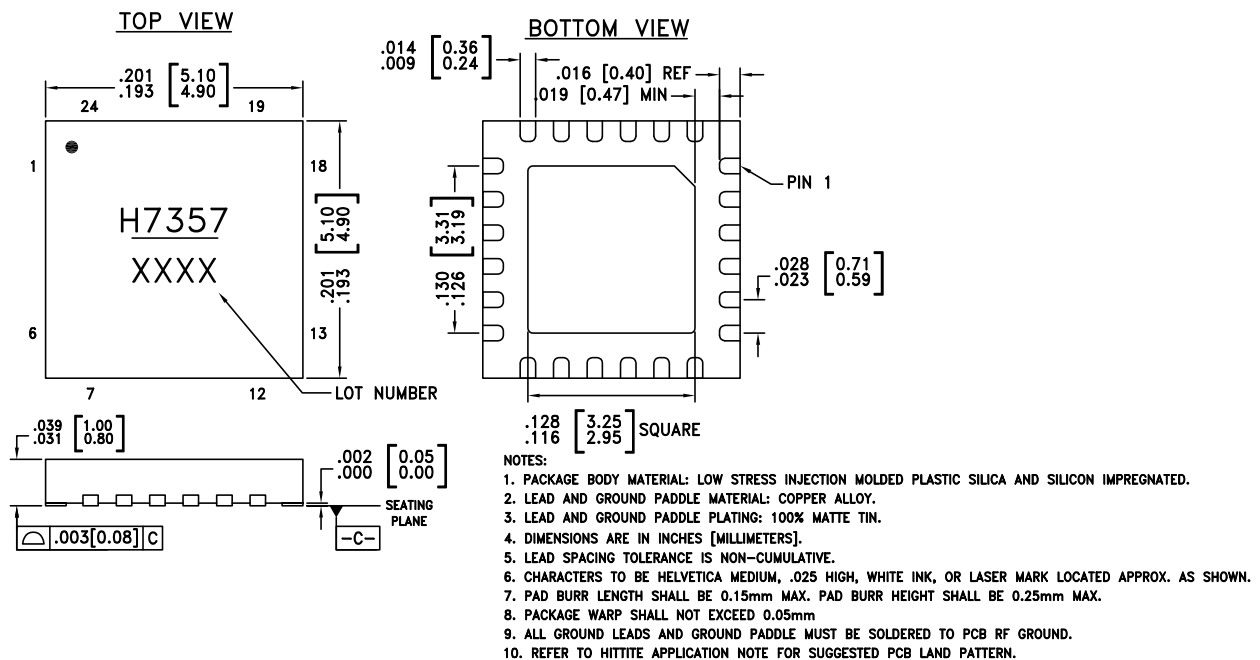

Package Information

Part Number	Package Body Material	Lead Finish	MSL Rating ^[2]	Package Marking ^[1]
HMC7357LP5GE	RoHS-compliant Low Stress Injection Molded Plastic	100% matte Sn	MSL1	H7357 XXXX

[1] 4-Digit lot number XXXX

[2] Max peak reflow temperature of 260 °C

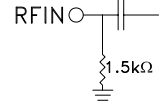
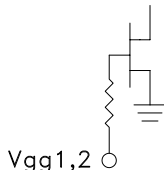
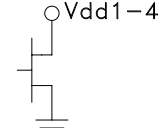
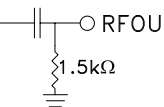

**GaAs pHEMT MMIC 2 WATT
POWER AMPLIFIER, 5.5 - 8.5 GHz**
Pin Descriptions

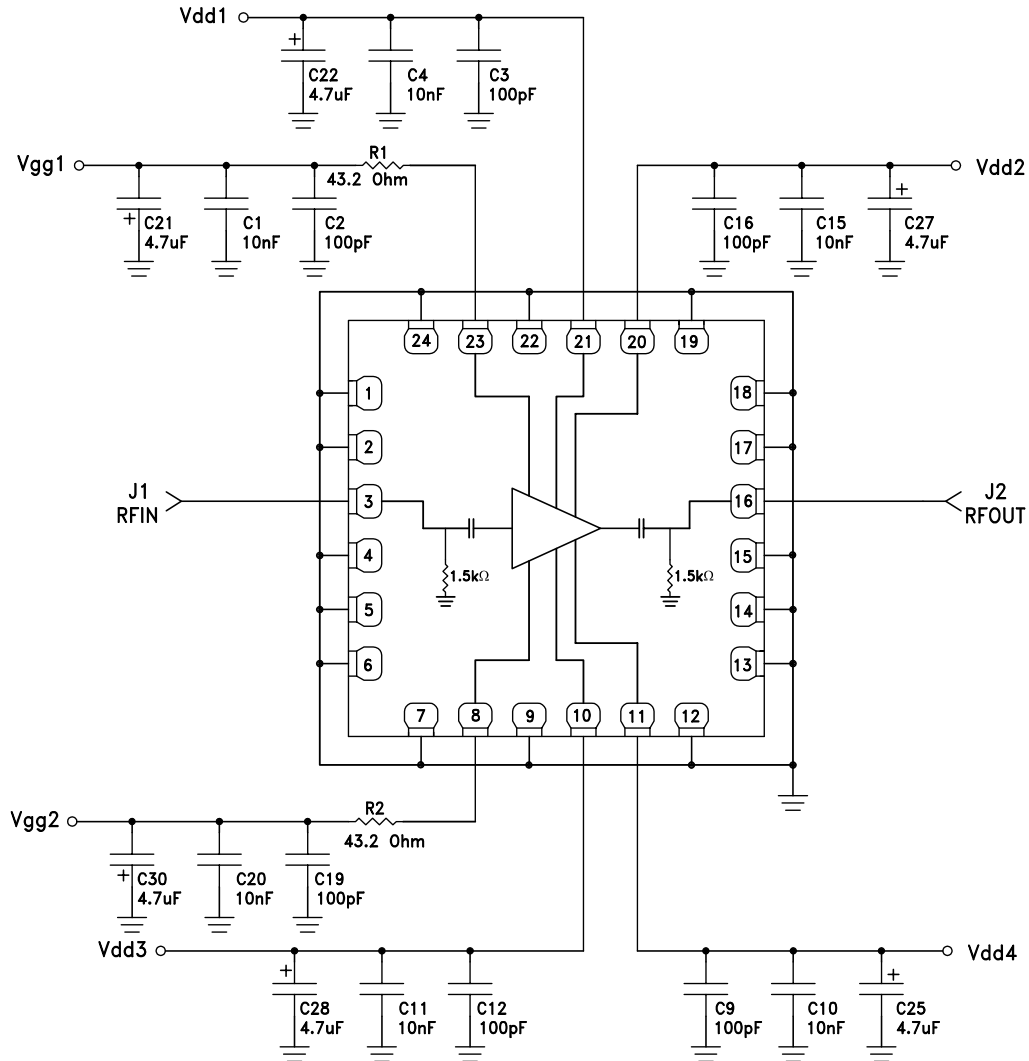
Pad Number	Function	Description	Interface Schematic
1, 4, 5, 6, 7, 9, 12, 13, 14, 17, 18, 19, 22, 24	N/C	These pins are not connected internally; however all data shown herein was measured with these pins connected to RF/DC ground externally.	
2, 15	GND	These pins and exposed ground paddle must be connected to RF/DC ground.	
3	RFIN	This pin is DC coupled and matched to 50 Ohms.	
8, 23	Vgg2, Vgg1	Gate control for PA. Adjust Vgg to achieve recommended bias current. External bypass capacitors of 100 pF, 10 nF, and 4.7 μF are required. Apply Vgg bias to either pin 8 or pin 23.	
10, 11, 20, 21	Vdd3, Vdd4, Vdd2, Vdd1	Drain bias voltage for the amplifier. External bypass capacitors of 100 pF, 10 nF, and 4.7 μF are required.	
16	RFOUT	This pin is DC coupled and matched to 50 Ohms.	

Application Circuit

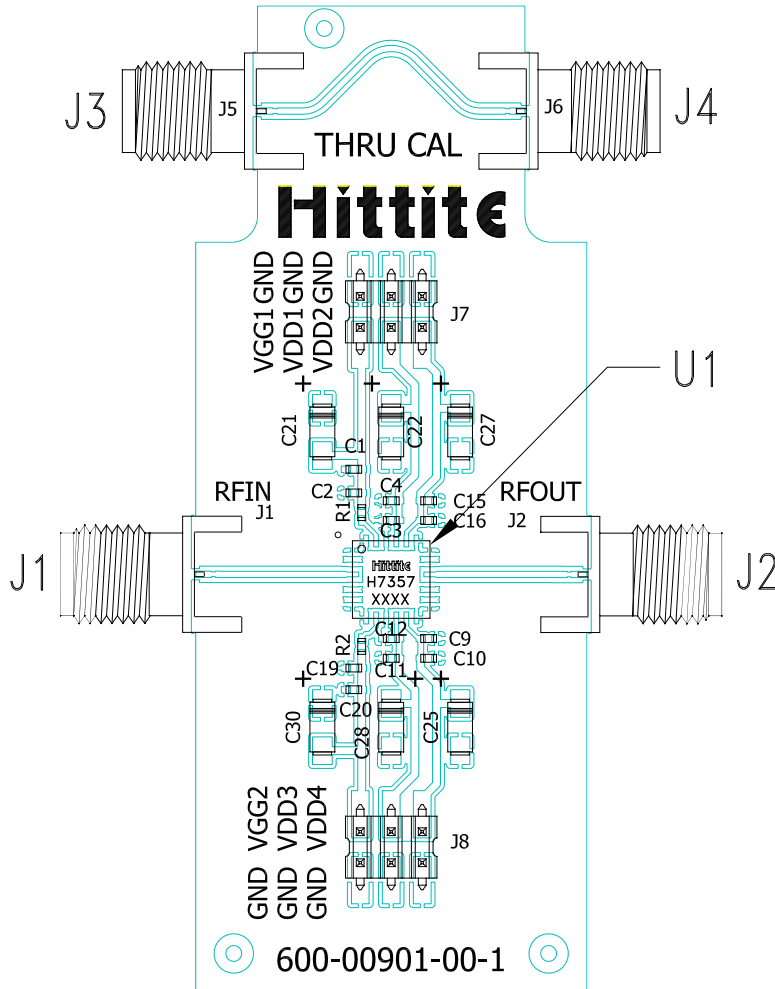

Evaluation PCB



List of Materials for Evaluation PCB EV1HMC7357LP5 [1]

Item	Description
J1 - J4	"K" Connector, SRI
J7, J8	DC Pin
C2, C3, C9, C12, C16, C19	100 pF Capacitor, 0402 Pkg.
C1, C4, C10, C11, C15, C20	10000 pF Capacitor, 0402 Pkg.
C21, C22, C25, C27, C28, C30	4.7 uF Capacitor, Case A Pkg.
R1, R2	43.2 Ohm Resistor, 0402 Pkg
U1	HMC7357LP5GE Amplifier
PCB [2]	600-00901-00 Eval Board

The circuit board used in the application should use RF circuit design techniques. Signal lines should have 50 Ohm impedance while the package ground leads and exposed paddle should be connected directly to the ground plane similar to that shown. A sufficient number of via holes should be used to connect the top and bottom ground planes. The evaluation circuit board shown is available from Hittite upon request.

[1] Reference this number when ordering complete evaluation PCB

[2] Circuit Board Material: Rogers 4350



**GaAs pHEMT MMIC 2 WATT
POWER AMPLIFIER, 5.5 - 8.5 GHz**

Notes:

Mouser Electronics

Authorized Distributor

Click to View Pricing, Inventory, Delivery & Lifecycle Information:

[Analog Devices Inc.:](#)

[HMC7357LP5GE](#) [EV1HMC7357LP5G](#) [HMC7357LP5GETR](#)