

FEATURES

Maximum temperature coefficient (TCV_{OUT}): 2 ppm/°C

Output noise (0.1 Hz to 10 Hz)

Less than 1 μV p-p at V_{OUT} of 2.048 V typical

Initial output voltage error: ±0.02% (maximum)

Input voltage range: 3 V to 15 V

Operating temperature: -40°C to +125°C

Output current: +10 mA source/-10 mA sink

Low quiescent current: 950 μA (maximum)

Low dropout voltage: 300 mV at 2 mA (V_{OUT} ≥ 3 V)

8-lead SOIC package

APPLICATIONS

Precision data acquisition systems

High resolution data converters

High precision measurement devices

Industrial instrumentation

Medical devices

Automotive battery monitoring

GENERAL DESCRIPTION

The [ADR4520/ADR4525/ADR4530/ADR4533/ADR4540/ADR4550](#) devices are high precision, low power, low noise voltage references featuring ±0.02% maximum initial error, excellent temperature stability, and low output noise.

This family of voltage references uses an innovative core topology to achieve high accuracy while offering industry-leading temperature stability and noise performance. The low, thermally induced output voltage hysteresis and low long-term output voltage drift of the devices also improve system accuracy over time and temperature variations.

A maximum operating current of 950 μA and a maximum low dropout voltage of 300 mV allow the devices to function very well in portable equipment.

The [ADR4520/ADR4525/ADR4530/ADR4533/ADR4540/ADR4550](#) series of references is provided in an 8-lead SOIC package and is available in a wide range of output voltages, all of which are specified over the extended industrial temperature range of -40°C to +125°C.

PIN CONFIGURATION

ADR4520/ADR4525/
ADR4530/ADR4533/
ADR4540/ADR4550

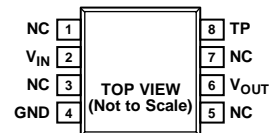

NOTES

1. NC = NO CONNECT.
2. TP = TEST PIN. DO NOT CONNECT.

10203-001

Figure 1. 8-Lead SOIC

Table 1. Selection Guide

Model	Output Voltage (V)
ADR4520	2.048
ADR4525	2.5
ADR4530	3.0
ADR4533	3.3
ADR4540	4.096
ADR4550	5.0

Table 2. Voltage Reference Choices from Analog Devices

V _{OUT} (V)	Low Cost/ Low Power	Micropower	Ultralow Noise	High Voltage, High Performance
2.048	ADR360 ADR3420	REF191	ADR430 ADR440	
2.5	ADR3425 AD1582 ADR361	ADR291 REF192	ADR431 ADR441	ADR03 AD780
5.0	ADR3450 AD1585 ADR365	ADR293 REF195	ADR435 ADR445	ADR02 AD586

Rev. 0

Information furnished by Analog Devices is believed to be accurate and reliable. However, no responsibility is assumed by Analog Devices for its use, nor for any infringements of patents or other rights of third parties that may result from its use. Specifications subject to change without notice. No license is granted by implication or otherwise under any patent or patent rights of Analog Devices. Trademarks and registered trademarks are the property of their respective owners.

TABLE OF CONTENTS

Features	1	ADR4520	11
Applications.....	1	ADR4525	14
Pin Configuration.....	1	ADR4530	17
General Description	1	ADR4533	20
Revision History	2	ADR4540	23
Specifications.....	3	ADR4550	26
ADR4520 Electrical Characteristics.....	3	Terminology	29
ADR4525 Electrical Characteristics.....	4	Theory of Operation	30
ADR4530 Electrical Characteristics.....	5	Long-Term Drift.....	30
ADR4533 Electrical Characteristics.....	6	Power Dissipation.....	30
ADR4540 Electrical Characteristics.....	7	Applications Information	31
ADR4550 Electrical Characteristics.....	8	Basic Voltage Reference Connection	31
Absolute Maximum Ratings.....	9	Input and Output Capacitors.....	31
Thermal Resistance	9	Location of Reference in System	31
ESD Caution.....	9	Sample Applications.....	31
Pin Configuration and Function Descriptions.....	10	Outline Dimensions	32
Typical Performance Characteristics	11	Ordering Guide.....	32

REVISION HISTORY

4/12—Revision 0: Initial Version

SPECIFICATIONS

ADR4520 ELECTRICAL CHARACTERISTICS

Unless otherwise noted, $V_{IN} = 3\text{ V}$ to 15 V , $I_L = 0\text{ mA}$, $T_A = 25^\circ\text{C}$.

Table 3.

Parameter	Symbol	Test Conditions/Comments	Min	Typ	Max	Unit
OUTPUT VOLTAGE	V_{OUT}			2.048		V
INITIAL OUTPUT VOLTAGE ERROR	V_{OUT_ERR}	B grade			± 0.02	%
		A grade			410	μV
					± 0.04	%
					820	μV
SOLDER HEAT SHIFT				± 0.02		%
TEMPERATURE COEFFICIENT	TCV_{OUT}	B grade, $-40^\circ\text{C} \leq T_A \leq +125^\circ\text{C}$ A grade, $-40^\circ\text{C} \leq T_A \leq +125^\circ\text{C}$			2	ppm/ $^\circ\text{C}$
					4	ppm/ $^\circ\text{C}$
LINE REGULATION	$\Delta V_{OUT}/\Delta V_{IN}$	$-40^\circ\text{C} \leq T_A \leq +125^\circ\text{C}$		1	10	ppm/V
LOAD REGULATION	$\Delta V_{OUT}/\Delta I_L$	$I_L = 0\text{ mA}$ to $+10\text{ mA}$ source, $-40^\circ\text{C} \leq T_A \leq +125^\circ\text{C}$ $I_L = 0\text{ mA}$ to -10 mA sink, $-40^\circ\text{C} \leq T_A \leq +125^\circ\text{C}$		30	80	ppm/mA
				100	120	ppm/mA
QUIESCENT CURRENT	I_Q	$-40^\circ\text{C} \leq T_A \leq +125^\circ\text{C}$, no load		700	950	μA
DROPOUT VOLTAGE	V_{DO}	$-40^\circ\text{C} \leq T_A \leq +125^\circ\text{C}$, no load $-40^\circ\text{C} \leq T_A \leq +125^\circ\text{C}$, $I_L = 2\text{ mA}$			1	V
					1	V
RIPPLE REJECTION RATIO	RRR	$f_{IN} = 1\text{ kHz}$		90		dB
OUTPUT CURRENT CAPACITY	I_L					
Sinking					-8	mA
Sourcing					10	mA
OUTPUT VOLTAGE NOISE	e_{Np-p}	0.1 Hz to 10.0 Hz		1.0		$\mu\text{V p-p}$
OUTPUT VOLTAGE NOISE DENSITY	e_N	1 kHz		35.8		nV/ $\sqrt{\text{Hz}}$
OUTPUT VOLTAGE HYSTERESIS	ΔV_{OUT_HYS}	$T_A =$ temperature cycled from $+25^\circ\text{C}$ to -40°C to $+125^\circ\text{C}$ and back to $+25^\circ\text{C}$		50		ppm
LONG-TERM DRIFT	ΔV_{OUT_LTD}	1000 hours at 60°C		25		ppm
TURN-ON SETTLING TIME	t_R	$I_L = 0\text{ mA}$, $C_L = 1\text{ }\mu\text{F}$, $C_{IN} = 0.1\text{ }\mu\text{F}$, $R_L = 1\text{ k}\Omega$		90		μs
LOAD CAPACITANCE			1		100	μF

ADR4525 ELECTRICAL CHARACTERISTICS

Unless otherwise noted, $V_{IN} = 3\text{ V}$ to 15 V , $I_L = 0\text{ mA}$, $T_A = 25^\circ\text{C}$.

Table 4.

Parameter	Symbol	Test Conditions/Comments	Min	Typ	Max	Unit
OUTPUT VOLTAGE	V_{OUT}			2.500		V
INITIAL OUTPUT VOLTAGE ERROR	V_{OUT_ERR}	B grade			± 0.02	%
		A grade			500	μV
					± 0.04	%
					1	mV
SOLDER HEAT SHIFT				± 0.02		%
TEMPERATURE COEFFICIENT	TCV_{OUT}	B grade, $-40^\circ\text{C} \leq T_A \leq +125^\circ\text{C}$			2	ppm/ $^\circ\text{C}$
		A grade, $-40^\circ\text{C} \leq T_A \leq +125^\circ\text{C}$			4	ppm/ $^\circ\text{C}$
LINE REGULATION	$\Delta V_{OUT}/\Delta V_{IN}$	$-40^\circ\text{C} \leq T_A \leq +125^\circ\text{C}$		1	10	ppm/V
LOAD REGULATION	$\Delta V_{OUT}/\Delta I_L$	$I_L = 0\text{ mA}$ to $+10\text{ mA}$ source, $-40^\circ\text{C} \leq T_A \leq +125^\circ\text{C}$		30	80	ppm/mA
		$I_L = 0\text{ mA}$ to -10 mA sink, $-40^\circ\text{C} \leq T_A \leq +125^\circ\text{C}$		60	120	ppm/mA
QUIESCENT CURRENT	I_Q	$-40^\circ\text{C} \leq T_A \leq +125^\circ\text{C}$, no load		700	950	μA
DROPOUT VOLTAGE	V_{DO}	$-40^\circ\text{C} \leq T_A \leq +125^\circ\text{C}$, no load			500	mV
		$-40^\circ\text{C} \leq T_A \leq +125^\circ\text{C}$, $I_L = 2\text{ mA}$			500	mV
RIPPLE REJECTION RATIO	RRR	$f_{IN} = 1\text{ kHz}$		90		dB
OUTPUT CURRENT CAPACITY	I_L				-10	mA
					10	mA
OUTPUT VOLTAGE NOISE	e_{Np-p}	0.1 Hz to 10.0 Hz		1.25		$\mu\text{V p-p}$
OUTPUT VOLTAGE NOISE DENSITY	e_N	1 kHz		41.3		nV/ $\sqrt{\text{Hz}}$
OUTPUT VOLTAGE HYSTERESIS	ΔV_{OUT_HYS}	$T_A = \text{temperature cycled from } +25^\circ\text{C to } -40^\circ\text{C to } +125^\circ\text{C and back to } +25^\circ\text{C}$		50		ppm
LONG-TERM DRIFT	ΔV_{OUT_LTD}	1000 hours at 60°C		25		ppm
TURN-ON SETTLING TIME	t_R	$I_L = 0\text{ mA}$, $C_L = 1\text{ }\mu\text{F}$, $C_{IN} = 0.1\text{ }\mu\text{F}$, $R_L = 1\text{ k}\Omega$		125		μs
LOAD CAPACITANCE			1		100	μF

ADR4530 ELECTRICAL CHARACTERISTICS

Unless otherwise noted, $V_{IN} = 3.1\text{ V}$ to 15 V , $I_L = 0\text{ mA}$, $T_A = 25^\circ\text{C}$.

Table 5.

Parameter	Symbol	Test Conditions/Comments	Min	Typ	Max	Unit
OUTPUT VOLTAGE	V_{OUT}			3.000		V
INITIAL OUTPUT VOLTAGE ERROR	V_{OUT_ERR}	B grade			± 0.02	%
		A grade			600	μV
					± 0.04	%
					1.2	mV
SOLDER HEAT SHIFT				± 0.02		%
TEMPERATURE COEFFICIENT	TCV_{OUT}	B grade, $-40^\circ\text{C} \leq T_A \leq +125^\circ\text{C}$ A grade, $-40^\circ\text{C} \leq T_A \leq +125^\circ\text{C}$			2	ppm/ $^\circ\text{C}$
					4	ppm/ $^\circ\text{C}$
LINE REGULATION	$\Delta V_{OUT}/\Delta V_{IN}$	$-40^\circ\text{C} \leq T_A \leq +125^\circ\text{C}$		1	10	ppm/V
LOAD REGULATION	$\Delta V_{OUT}/\Delta I_L$	$I_L = 0\text{ mA}$ to $+10\text{ mA}$ source, $-40^\circ\text{C} \leq T_A \leq +125^\circ\text{C}$ $I_L = 0\text{ mA}$ to -10 mA sink, $-40^\circ\text{C} \leq T_A \leq +125^\circ\text{C}$		30	80	ppm/mA
				60	120	ppm/mA
QUIESCENT CURRENT	I_Q	$-40^\circ\text{C} \leq T_A \leq +125^\circ\text{C}$, no load		700	950	μA
DROPOUT VOLTAGE	V_{DO}	$-40^\circ\text{C} \leq T_A \leq +125^\circ\text{C}$, no load $-40^\circ\text{C} \leq T_A \leq +125^\circ\text{C}$, $I_L = 2\text{ mA}$			100	mV
					300	mV
RIPPLE REJECTION RATIO	RRR	$f_{IN} = 1\text{ kHz}$		90		dB
OUTPUT CURRENT CAPACITY	I_L					
Sinking					-10	mA
Sourcing					10	mA
OUTPUT VOLTAGE NOISE	e_{NP-p}	0.1 Hz to 10.0 Hz		1.6		$\mu\text{V p-p}$
OUTPUT VOLTAGE NOISE DENSITY	e_N	1 kHz		60		nV/ $\sqrt{\text{Hz}}$
OUTPUT VOLTAGE HYSTERESIS	ΔV_{OUT_HYS}	$T_A =$ temperature cycled from $+25^\circ\text{C}$ to -40°C to $+125^\circ\text{C}$ and back to $+25^\circ\text{C}$		50		ppm
LONG-TERM DRIFT	ΔV_{OUT_LTD}	1000 hours at 60°C		25		ppm
TURN-ON SETTLING TIME	t_R	$I_L = 0\text{ mA}$, $C_L = 0.1\text{ }\mu\text{F}$, $C_{IN} = 0.1\text{ }\mu\text{F}$, $R_L = 1\text{ k}\Omega$		130		μs
LOAD CAPACITANCE			0.1		100	μF

ADR4533 ELECTRICAL CHARACTERISTICS

Unless otherwise noted, $V_{IN} = 3.4\text{ V}$ to 15 V , $I_L = 0\text{ mA}$, $T_A = 25^\circ\text{C}$.

Table 6.

Parameter	Symbol	Test Conditions/Comments	Min	Typ	Max	Unit	
OUTPUT VOLTAGE	V_{OUT}			3.300		V	
INITIAL OUTPUT VOLTAGE ERROR	V_{OUT_ERR}	B grade			± 0.02	%	
					660	μV	
			A grade			± 0.04	%
						1.32	mV
SOLDER HEAT SHIFT			± 0.02		%		
TEMPERATURE COEFFICIENT	TCV_{OUT}	B grade, $-40^\circ\text{C} \leq T_A \leq +125^\circ\text{C}$			2	ppm/ $^\circ\text{C}$	
		A grade, $-40^\circ\text{C} \leq T_A \leq +125^\circ\text{C}$			4	ppm/ $^\circ\text{C}$	
LINE REGULATION	$\Delta V_{OUT}/\Delta V_{IN}$	$-40^\circ\text{C} \leq T_A \leq +125^\circ\text{C}$		1	10	ppm/V	
LOAD REGULATION	$\Delta V_{OUT}/\Delta I_L$	$I_L = 0\text{ mA}$ to $+10\text{ mA}$ source, $-40^\circ\text{C} \leq T_A \leq +125^\circ\text{C}$		30	80	ppm/mA	
		$I_L = 0\text{ mA}$ to -10 mA sink, $-40^\circ\text{C} \leq T_A \leq +125^\circ\text{C}$		60	120	ppm/mA	
QUIESCENT CURRENT	I_Q	$-40^\circ\text{C} \leq T_A \leq +125^\circ\text{C}$, no load		700	950	μA	
DROPOUT VOLTAGE	V_{DO}	$-40^\circ\text{C} \leq T_A \leq +125^\circ\text{C}$, no load			100	mV	
		$-40^\circ\text{C} \leq T_A \leq +125^\circ\text{C}$, $I_L = 2\text{ mA}$			300	mV	
RIPPLE REJECTION RATIO	RRR	$f_{IN} = 1\text{ kHz}$		90		dB	
OUTPUT CURRENT CAPACITY	I_L				-10	mA	
					10	mA	
OUTPUT VOLTAGE NOISE	e_{Np-p}	0.1 Hz to 10.0 Hz		2.1		$\mu\text{V p-p}$	
OUTPUT VOLTAGE NOISE DENSITY	e_N	1 kHz		64.2		nV/ $\sqrt{\text{Hz}}$	
OUTPUT VOLTAGE HYSTERESIS	ΔV_{OUT_HYS}	$T_A =$ temperature cycled from $+25^\circ\text{C}$ to -40°C to $+125^\circ\text{C}$ and back to $+25^\circ\text{C}$		50		ppm	
LONG-TERM DRIFT	ΔV_{OUT_LTD}	1000 hours at 60°C		25		ppm	
TURN-ON SETTLING TIME	t_R	$I_L = 0\text{ mA}$, $C_L = 0.1\text{ }\mu\text{F}$, $C_{IN} = 0.1\text{ }\mu\text{F}$, $R_L = 1\text{ k}\Omega$		135		μs	
LOAD CAPACITANCE			0.1		100	μF	

ADR4540 ELECTRICAL CHARACTERISTICS

Unless otherwise noted, $V_{IN} = 4.2\text{ V}$ to 15 V , $I_L = 0\text{ mA}$, $T_A = 25^\circ\text{C}$.

Table 7.

Parameter	Symbol	Test Conditions/Comments	Min	Typ	Max	Unit
OUTPUT VOLTAGE	V_{OUT}			4.096		V
INITIAL OUTPUT VOLTAGE ERROR	V_{OUT_ERR}	B grade			± 0.02	%
		A grade			820	μV
					± 0.04	%
					1.64	mV
SOLDER HEAT SHIFT				± 0.02		%
TEMPERATURE COEFFICIENT	TCV_{OUT}	B grade, $-40^\circ\text{C} \leq T_A \leq +125^\circ\text{C}$ A grade, $-40^\circ\text{C} \leq T_A \leq +125^\circ\text{C}$			2	ppm/ $^\circ\text{C}$
					4	ppm/ $^\circ\text{C}$
LINE REGULATION	$\Delta V_{OUT}/\Delta V_{IN}$	$-40^\circ\text{C} \leq T_A \leq +125^\circ\text{C}$		1	10	ppm/V
LOAD REGULATION	$\Delta V_{OUT}/\Delta I_L$	$I_L = 0\text{ mA}$ to $+10\text{ mA}$ source, $-40^\circ\text{C} \leq T_A \leq +125^\circ\text{C}$ $I_L = 0\text{ mA}$ to -10 mA sink, $-40^\circ\text{C} \leq T_A \leq +125^\circ\text{C}$		25	80	ppm/mA
				50	120	ppm/mA
QUIESCENT CURRENT	I_Q	$-40^\circ\text{C} \leq T_A \leq +125^\circ\text{C}$, no load		700	950	μA
DROPOUT VOLTAGE	V_{DO}	$-40^\circ\text{C} \leq T_A \leq +125^\circ\text{C}$, no load $-40^\circ\text{C} \leq T_A \leq +125^\circ\text{C}$, $I_L = 2\text{ mA}$			100	mV
					300	mV
RIPPLE REJECTION RATIO	RRR	$f_{IN} = 1\text{ kHz}$		90		dB
OUTPUT CURRENT CAPACITY	I_L				-10	mA
Sinking					10	mA
Sourcing						
OUTPUT VOLTAGE NOISE	e_{Np-p}	0.1 Hz to 10.0 Hz		2.7		$\mu\text{V p-p}$
OUTPUT VOLTAGE NOISE DENSITY	e_N	1 kHz		83.5		nV/ $\sqrt{\text{Hz}}$
OUTPUT VOLTAGE HYSTERESIS	ΔV_{OUT_HYS}	$T_A =$ temperature cycled from $+25^\circ\text{C}$ to -40°C to $+125^\circ\text{C}$ and back to $+25^\circ\text{C}$		50		ppm
LONG-TERM DRIFT	ΔV_{OUT_LTD}	1000 hours at 60°C		25		ppm
TURN-ON SETTLING TIME	t_R	$I_L = 0\text{ mA}$, $C_L = 0.1\text{ }\mu\text{F}$, $C_{IN} = 0.1\text{ }\mu\text{F}$, $R_L = 1\text{ k}\Omega$		155		μs
LOAD CAPACITANCE			0.1		100	μF

ADR4550 ELECTRICAL CHARACTERISTICS

Unless otherwise noted, $V_{IN} = 5.1\text{ V}$ to 15 V , $I_L = 0\text{ mA}$, $T_A = 25^\circ\text{C}$.

Table 8.

Parameter	Symbol	Test Conditions/Comments	Min	Typ	Max	Unit
OUTPUT VOLTAGE	V_{OUT}			5.000		V
INITIAL OUTPUT VOLTAGE ERROR	V_{OUT_ERR}	B grade			± 0.02	%
		A grade			1	mV
					± 0.04	%
					2	mV
SOLDER HEAT SHIFT				± 0.02		%
TEMPERATURE COEFFICIENT	TCV_{OUT}	B grade, $-40^\circ\text{C} \leq T_A \leq +125^\circ\text{C}$			2	ppm/ $^\circ\text{C}$
		A grade, $-40^\circ\text{C} \leq T_A \leq +125^\circ\text{C}$			4	ppm/ $^\circ\text{C}$
LINE REGULATION	$\Delta V_{OUT}/\Delta V_{IN}$	$-40^\circ\text{C} \leq T_A \leq +125^\circ\text{C}$		1	10	ppm/V
LOAD REGULATION	$\Delta V_{OUT}/\Delta I_L$	$I_L = 0\text{ mA}$ to $+10\text{ mA}$ source, $-40^\circ\text{C} \leq T_A \leq +125^\circ\text{C}$		25	80	ppm/mA
		$I_L = 0\text{ mA}$ to -10 mA sink, $-40^\circ\text{C} \leq T_A \leq +125^\circ\text{C}$		35	120	ppm/mA
QUIESCENT CURRENT	I_Q	$-40^\circ\text{C} \leq T_A \leq +125^\circ\text{C}$, no load		700	950	μA
DROPOUT VOLTAGE	V_{DO}	$-40^\circ\text{C} \leq T_A \leq +125^\circ\text{C}$, no load			100	mV
		$-40^\circ\text{C} \leq T_A \leq +125^\circ\text{C}$, $I_L = 2\text{ mA}$			300	mV
RIPPLE REJECTION RATIO	RRR	$f_{IN} = 1\text{ kHz}$		90		dB
OUTPUT CURRENT CAPACITY	I_L				-10	mA
					10	mA
OUTPUT VOLTAGE NOISE	e_{Np-p}	0.1 Hz to 10.0 Hz		2.8		$\mu\text{V p-p}$
OUTPUT VOLTAGE NOISE DENSITY	e_N	1 kHz		95.3		nV/ $\sqrt{\text{Hz}}$
OUTPUT VOLTAGE HYSTERESIS	ΔV_{OUT_HYS}	$T_A =$ temperature cycled from $+25^\circ\text{C}$ to -40°C to $+125^\circ\text{C}$ and back to $+25^\circ\text{C}$		50		ppm
LONG-TERM DRIFT	ΔV_{OUT_LTD}	1000 hours at 60°C		25		ppm
TURN-ON SETTLING TIME	t_R	$I_L = 0\text{ mA}$, $C_L = 0.1\ \mu\text{F}$, $C_{IN} = 0.1\ \mu\text{F}$, $R_L = 1\text{ k}\Omega$		160		μs
LOAD CAPACITANCE			0.1		100	μF

ABSOLUTE MAXIMUM RATINGS

$T_A = 25^\circ\text{C}$, unless otherwise noted.

Table 9.

Parameter	Rating
Supply Voltage	16 V
Operating Temperature Range	-40°C to $+125^\circ\text{C}$
Storage Temperature Range	-65°C to $+150^\circ\text{C}$
Junction Temperature Range	-65°C to $+150^\circ\text{C}$

Stresses above those listed under Absolute Maximum Ratings may cause permanent damage to the device. This is a stress rating only; functional operation of the device at these or any other conditions above those indicated in the operational section of this specification is not implied. Exposure to absolute maximum rating conditions for extended periods may affect device reliability.

THERMAL RESISTANCE

θ_{JA} is specified for the worst-case conditions; that is, a device soldered in a circuit board for surface-mount packages.

Table 10. Thermal Resistance

Package Type	θ_{JA}	θ_{JC}	Unit
8-Lead SOIC	120	42	$^\circ\text{C}/\text{W}$

ESD CAUTION



ESD (electrostatic discharge) sensitive device. Charged devices and circuit boards can discharge without detection. Although this product features patented or proprietary protection circuitry, damage may occur on devices subjected to high energy ESD. Therefore, proper ESD precautions should be taken to avoid performance degradation or loss of functionality.

PIN CONFIGURATION AND FUNCTION DESCRIPTIONS

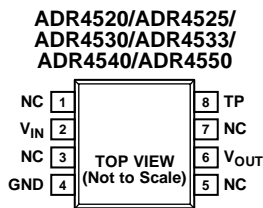

NOTES
 1. NC = NO CONNECT.
 2. TP = TEST PIN. DO NOT CONNECT.

10203-002

Figure 2. Pin Configuration

Table 11. Pin Function Descriptions

Pin No.	Mnemonic	Description
1	NC	No Connect. This pin is not connected internally.
2	V _{IN}	Input Voltage Connection.
3	NC	No Connect. This pin is not connected internally.
4	GND	Ground.
5	NC	No Connect. This pin is not connected internally.
6	V _{OUT}	Output Voltage.
7	NC	No Connect. This pin is not connected internally.
8	TP	Test Pin. Do not connect.

TYPICAL PERFORMANCE CHARACTERISTICS

T_A = 25°C, unless otherwise noted.

ADR4520

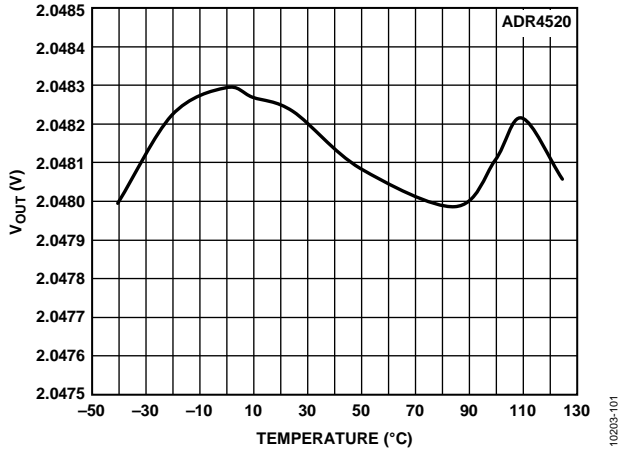

Figure 3. ADR4520 Output Voltage vs. Temperature

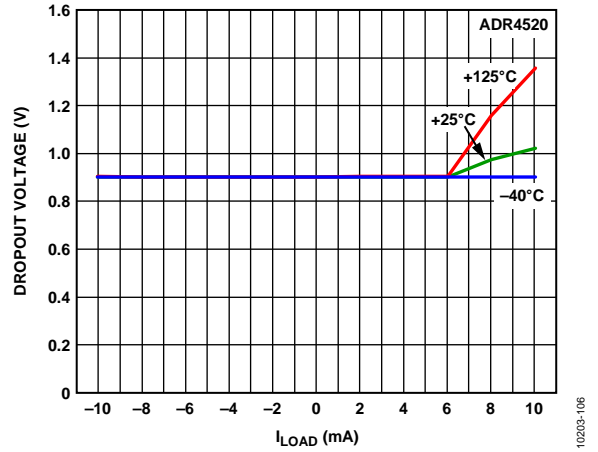

Figure 6. ADR4520 Dropout Voltage vs. Load Current

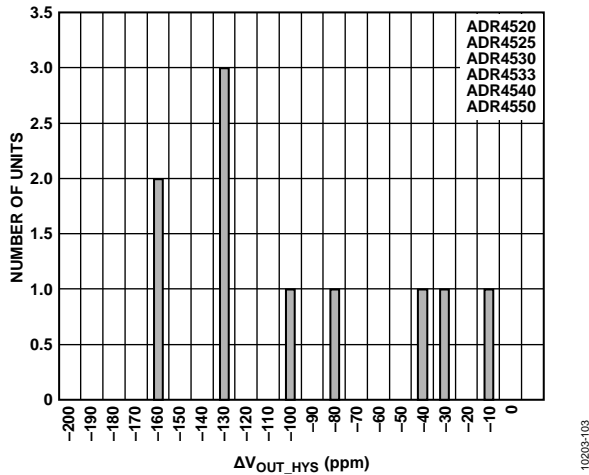

Figure 4. ADR4520 Thermally Induced Output Voltage Hysteresis Distribution

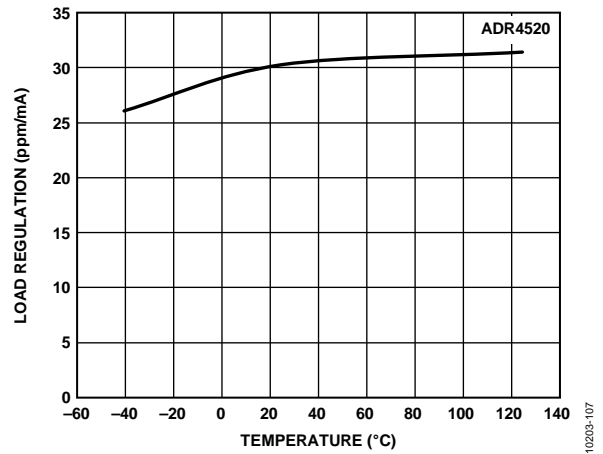

Figure 7. ADR4520 Load Regulation vs. Temperature (Sourcing)

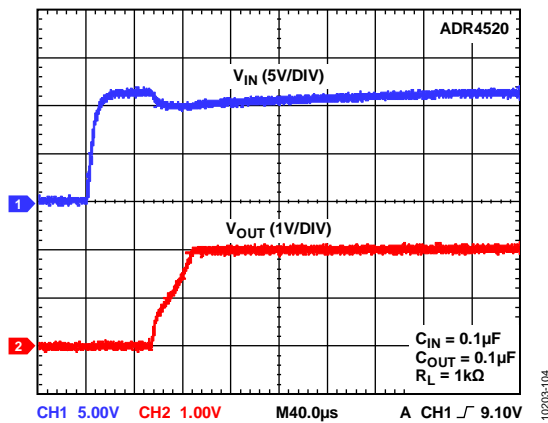

Figure 5. ADR4520 Output Voltage Start-Up Response

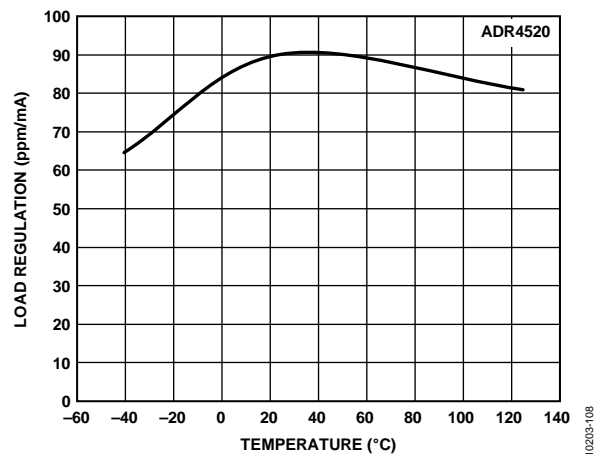

Figure 8. ADR4520 Load Regulation vs. Temperature (Sinking)

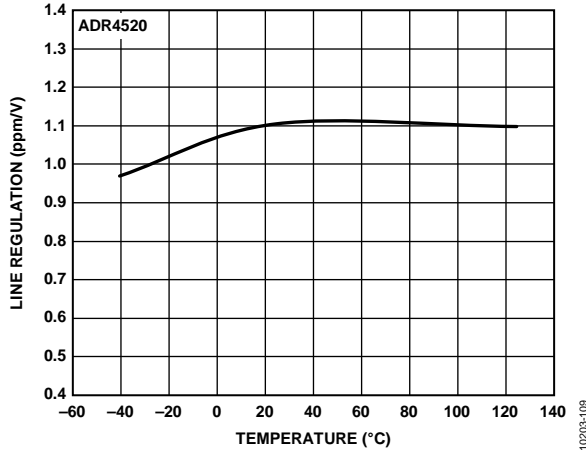

Figure 9. ADR4520 Line Regulation vs. Temperature

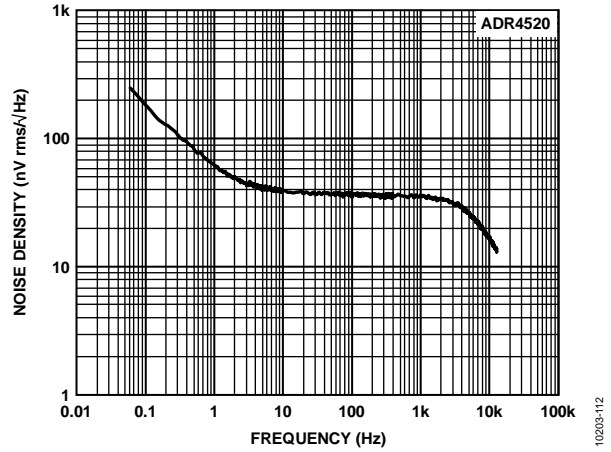

Figure 12. ADR4520 Output Noise Spectral Density

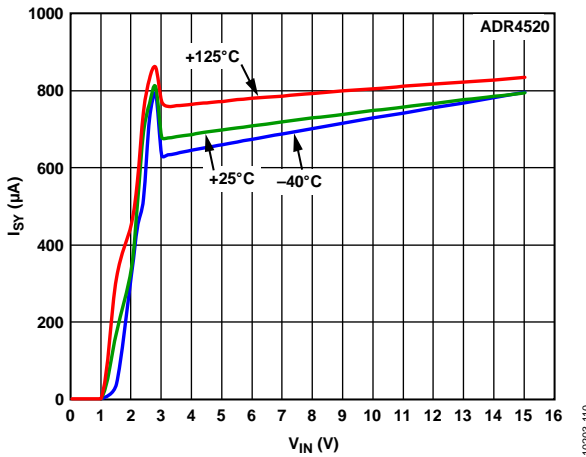

Figure 10. ADR4520 Supply Current vs. Supply Voltage

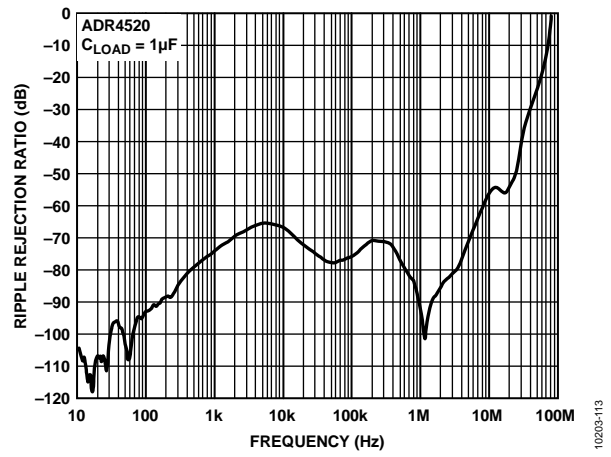

Figure 13. ADR4520 Ripple Rejection Ratio vs. Frequency

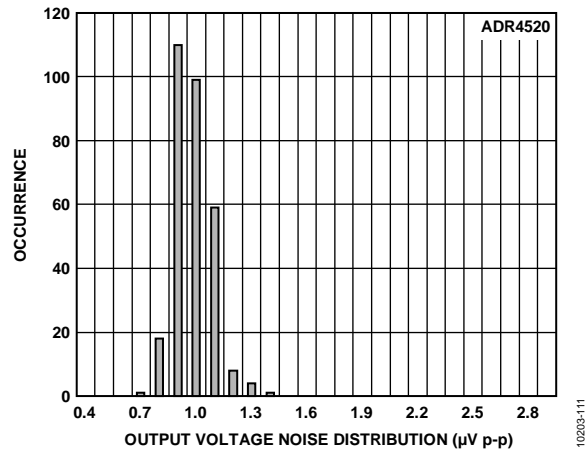

Figure 11. ADR4520 Output Voltage Noise (Maximum Amplitude from 0.1 Hz to 10 Hz)

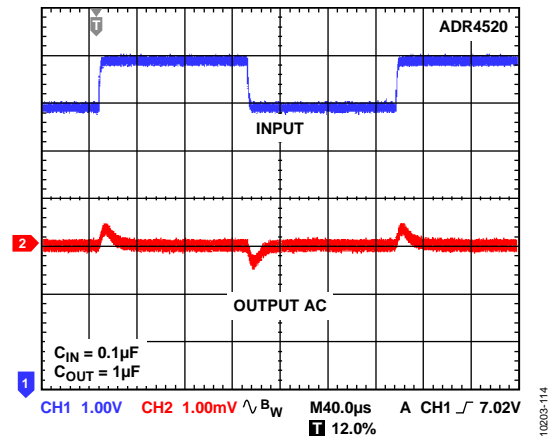

Figure 14. ADR4520 Line Transient Response

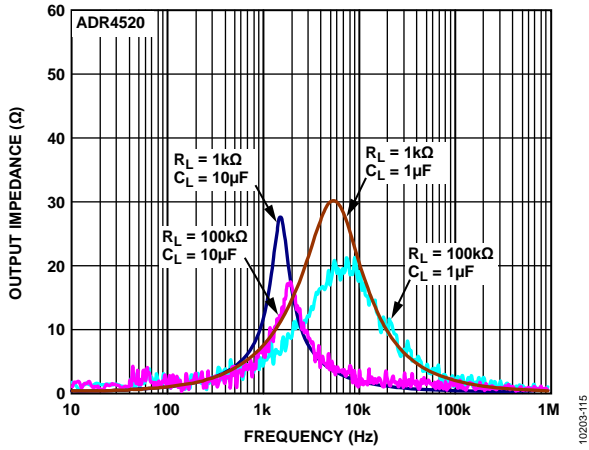

Figure 15. ADR4520 Output Impedance vs. Frequency

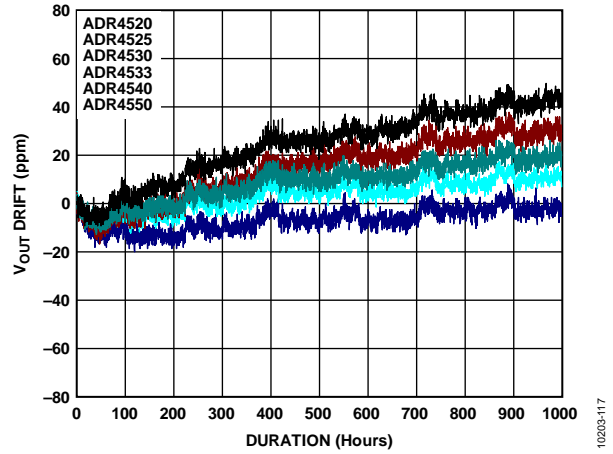

Figure 17. ADR4520 Typical Long-Term Output Voltage Drift (1000 Hours)

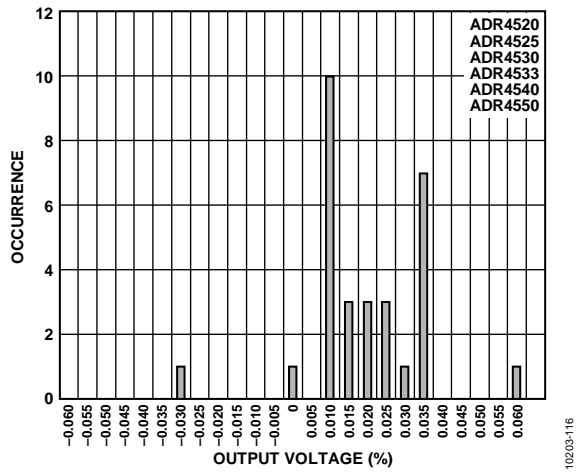

Figure 16. ADR4520 Output Voltage Drift Distribution After Reflow (SHR Drift)

ADR4525

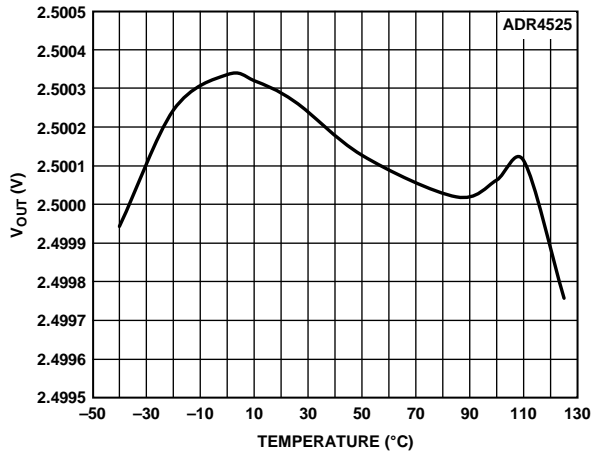

Figure 18. ADR4525 Output Voltage vs. Temperature

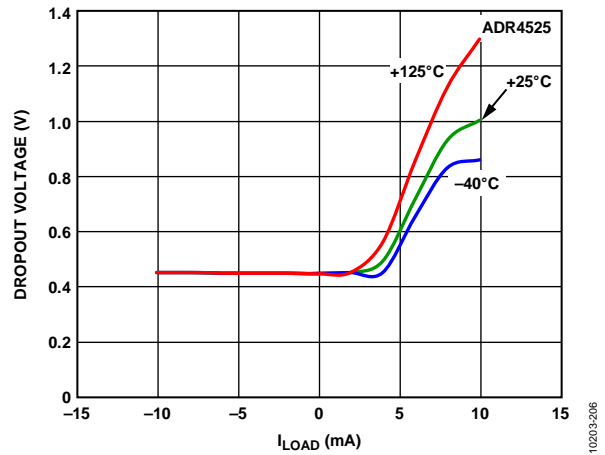

Figure 21. ADR4525 Dropout Voltage vs. Load Current

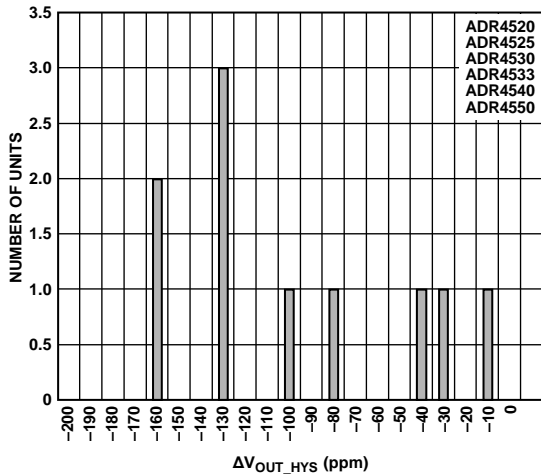

Figure 19. ADR4525 Thermally Induced Output Voltage Hysteresis Distribution

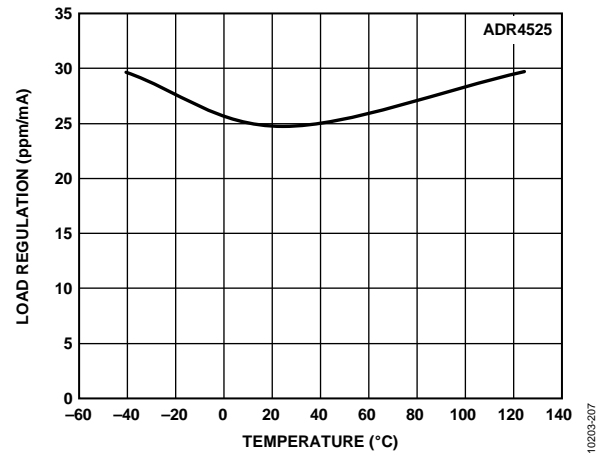

Figure 22. ADR4525 Load Regulation vs. Temperature (Sourcing)

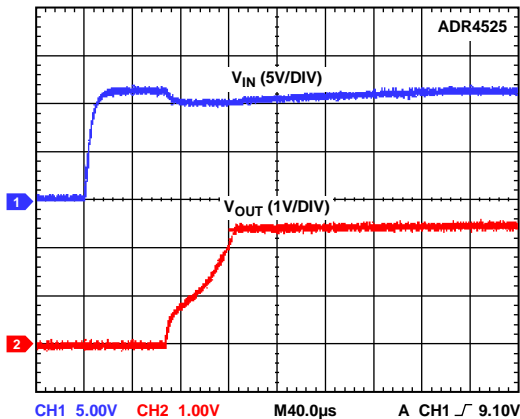

Figure 20. ADR4525 Output Voltage Start-Up Response

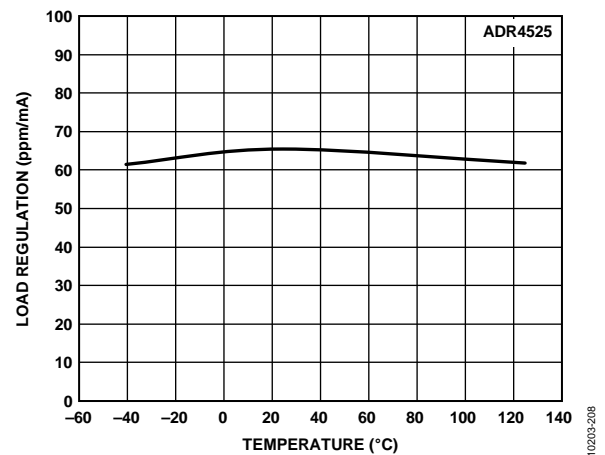

Figure 23. ADR4525 Load Regulation vs. Temperature (Sinking)

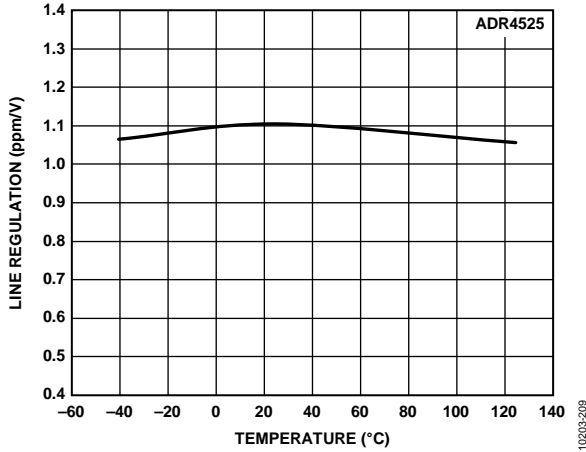

Figure 24. ADR4525 Line Regulation vs. Temperature

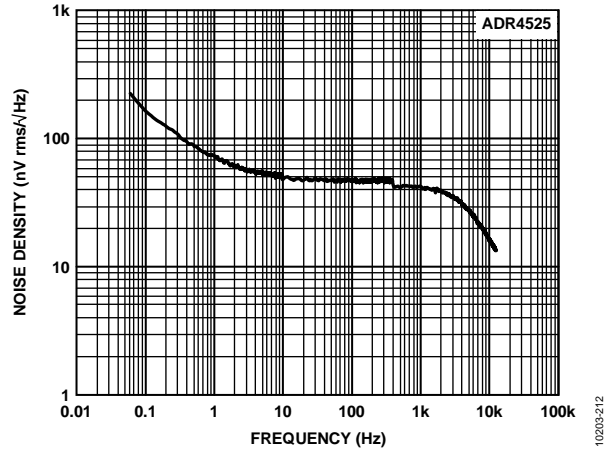

Figure 27. ADR4525 Output Noise Spectral Density

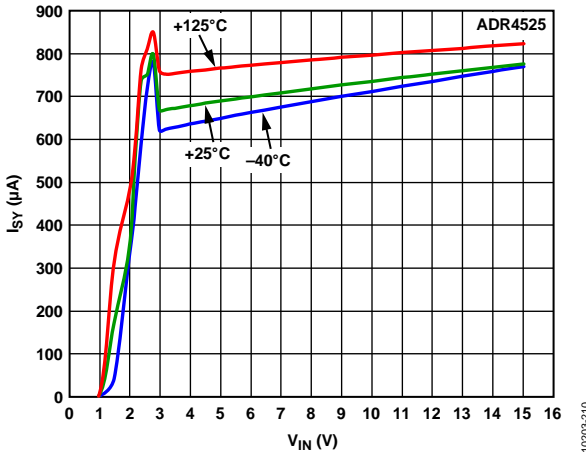

Figure 25. ADR4525 Supply Current vs. Supply Voltage

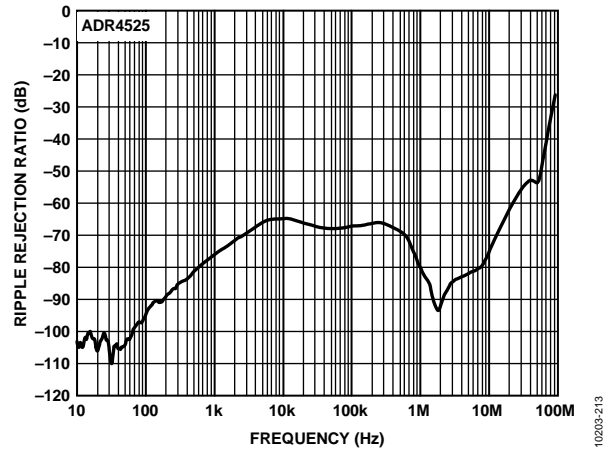

Figure 28. ADR4525 Ripple Rejection Ratio vs. Frequency

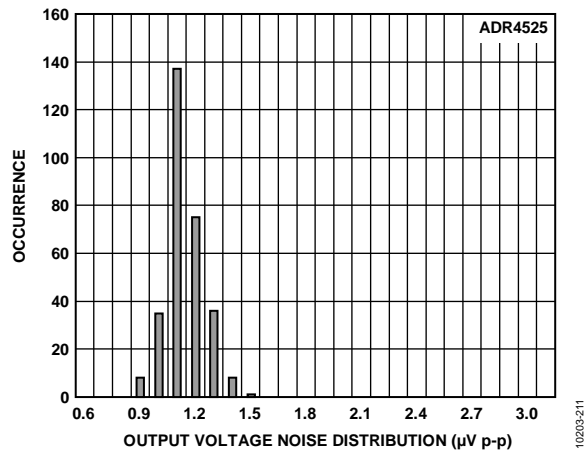

Figure 26. ADR4525 Output Voltage Noise (Maximum Amplitude from 0.1 Hz to 10 Hz)

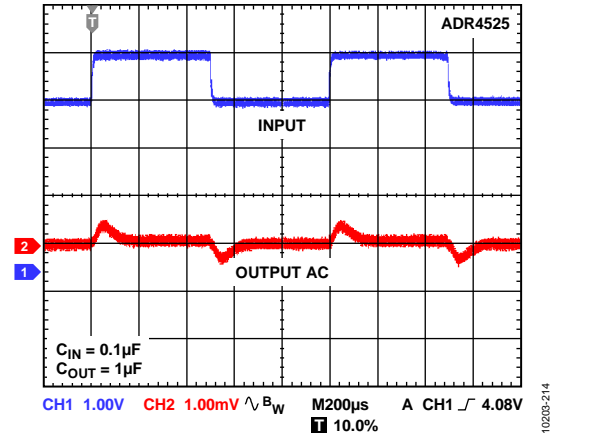

Figure 29. ADR4525 Line Transient Response

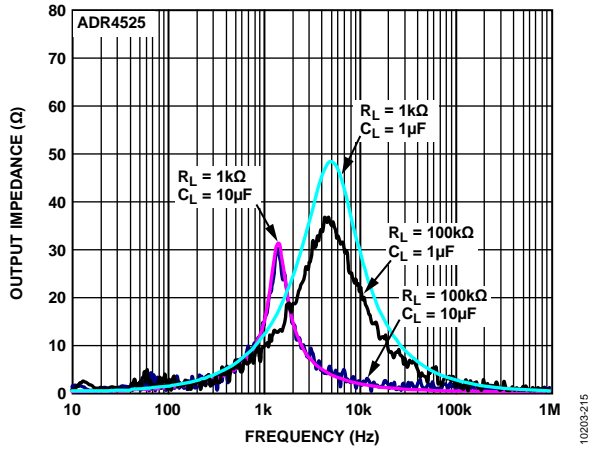

Figure 30. ADR4525 Output Impedance vs. Frequency

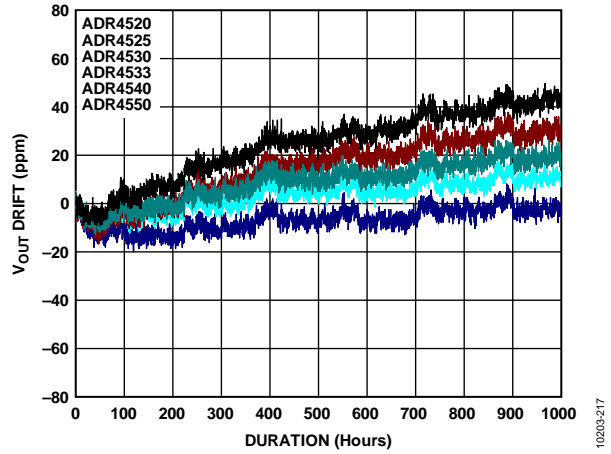

Figure 32. ADR4525 Typical Long-Term Output Voltage Drift (1000 Hours)

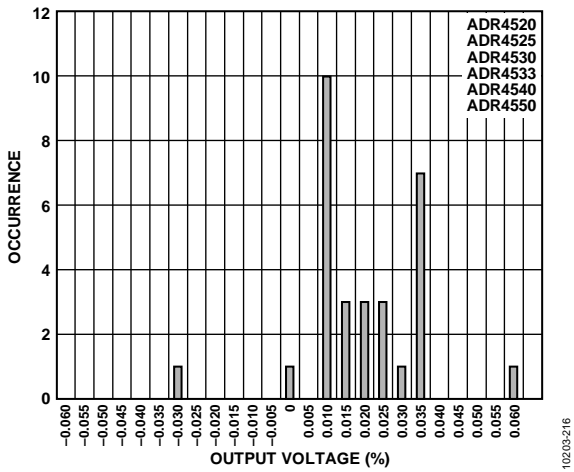

Figure 31. ADR4525 Output Voltage Drift Distribution After Reflow (SHR Drift)

ADR4530

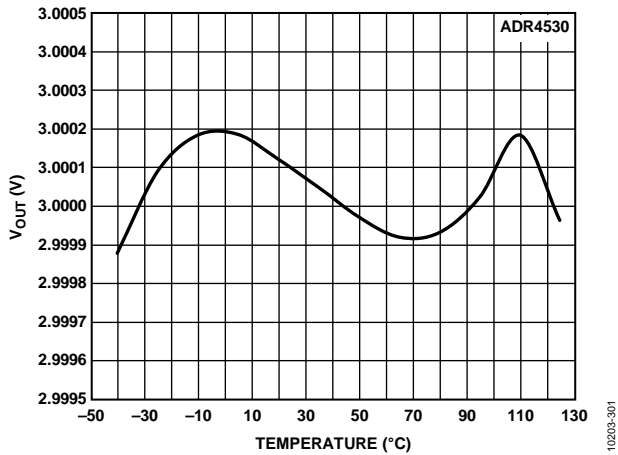

Figure 33. ADR4530 Output Voltage vs. Temperature

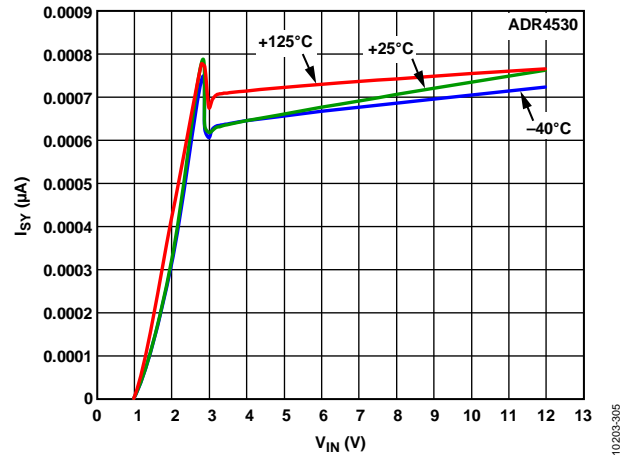

Figure 36. ADR4530 Supply Current vs. Supply Voltage

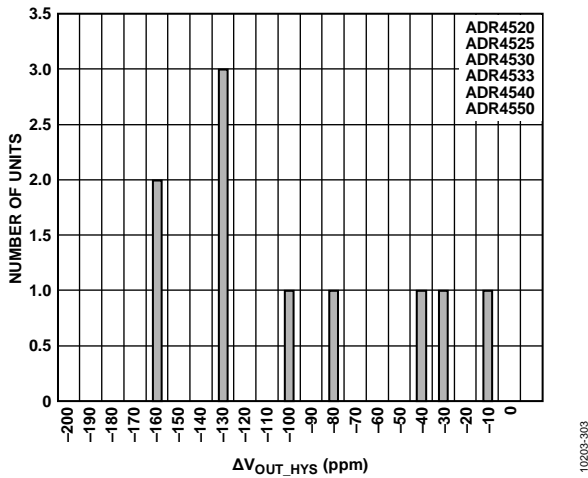

Figure 34. ADR4530 Thermally Induced Output Voltage Hysteresis Distribution

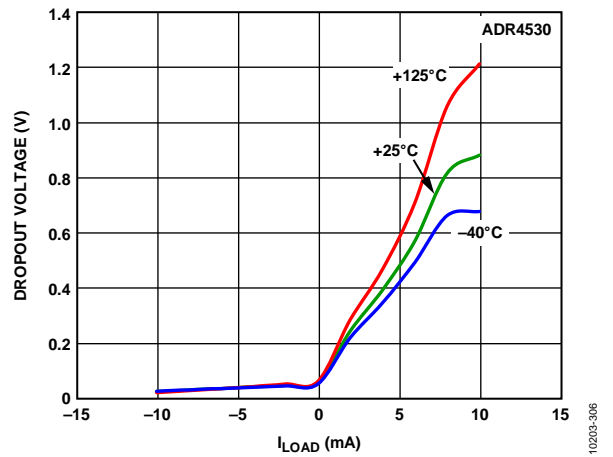

Figure 37. ADR4530 Dropout Voltage vs. Load Current

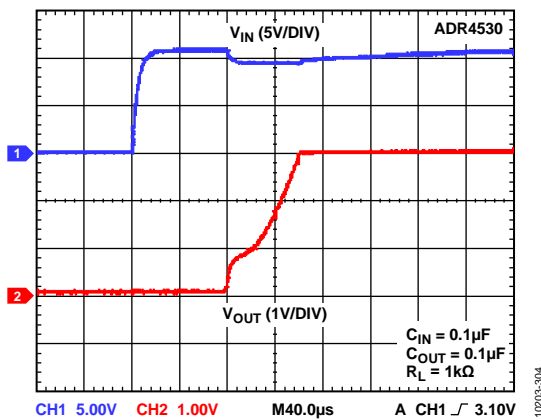

Figure 35. ADR4530 Output Voltage Start-Up Response

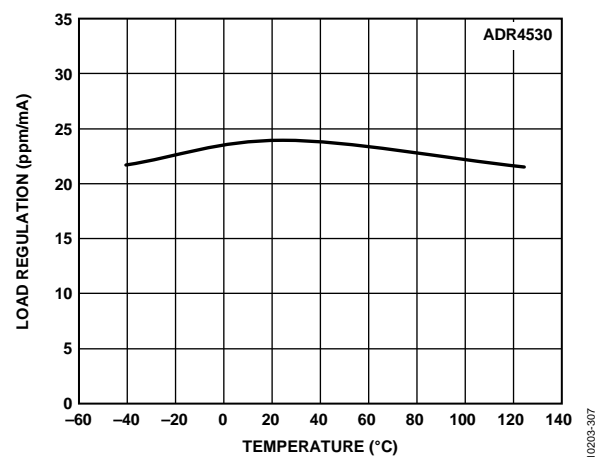

Figure 38. ADR4530 Load Regulation vs. Temperature (Sourcing)

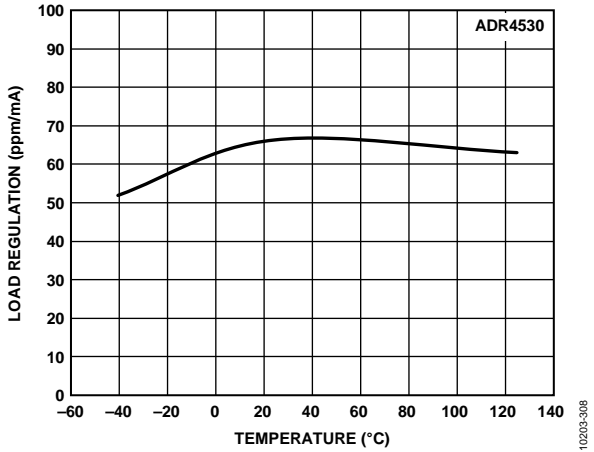

Figure 39. ADR4530 Load Regulation vs. Temperature (Sinking)

10203-308

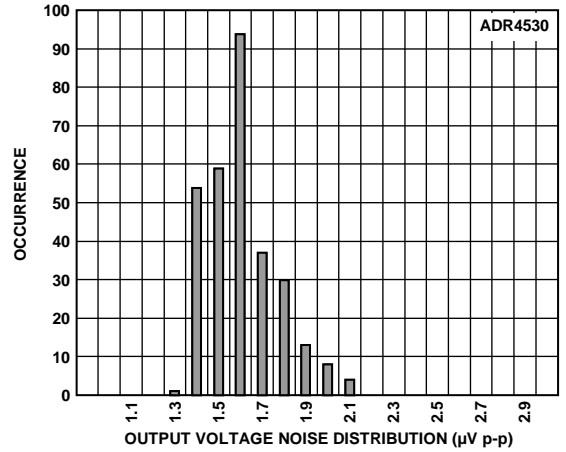

Figure 42. ADR4530 Output Voltage Noise (Maximum Amplitude from 0.1 Hz to 10 Hz)

10203-311

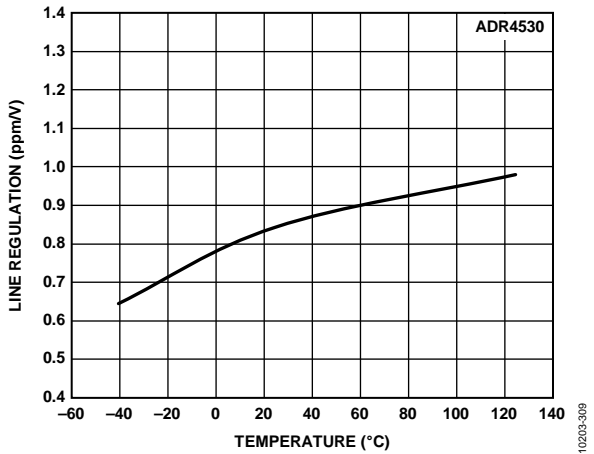

Figure 40. ADR4530 Line Regulation vs. Temperature

10203-309

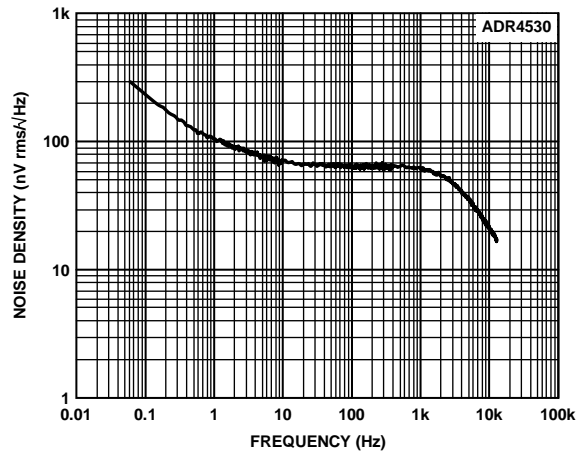

Figure 43. ADR4530 Output Noise Spectral Density

10203-312

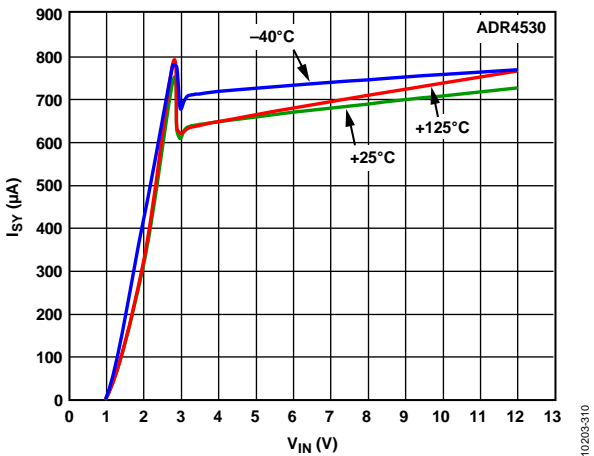

Figure 41. ADR4530 Supply Current vs. Supply Voltage

10203-310

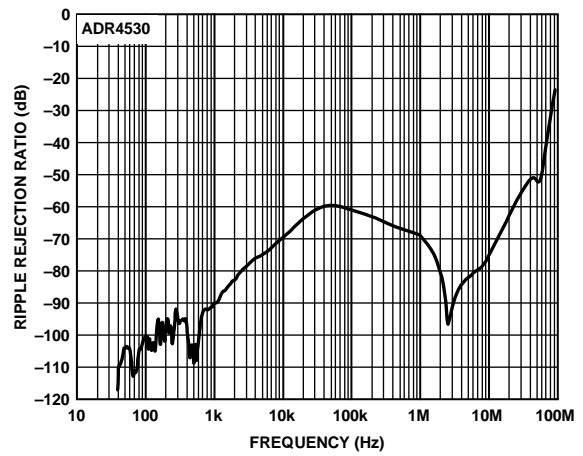

Figure 44. ADR4530 Ripple Rejection Ratio vs. Frequency

10203-313

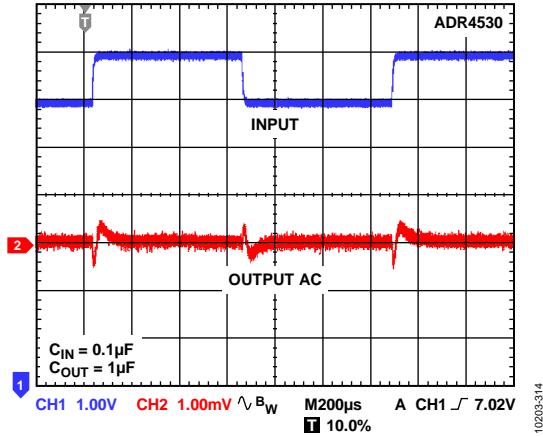

Figure 45. ADR4530 Line Transient Response

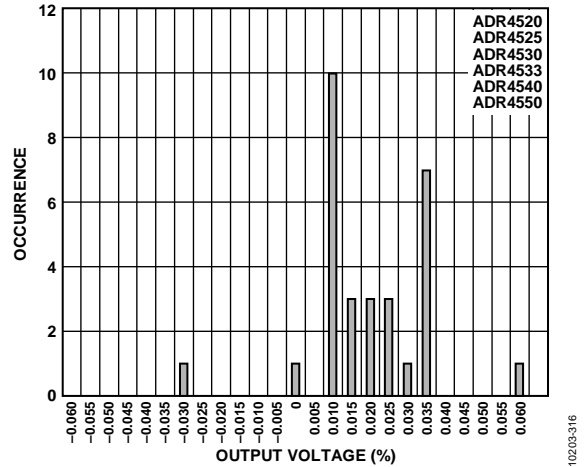

Figure 47. ADR4530 Output Voltage Drift Distribution After Reflow (SHR Drift)

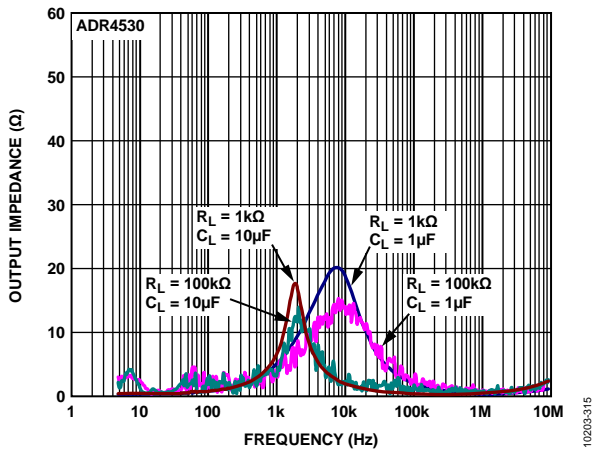

Figure 46. ADR4530 Output Impedance vs. Frequency

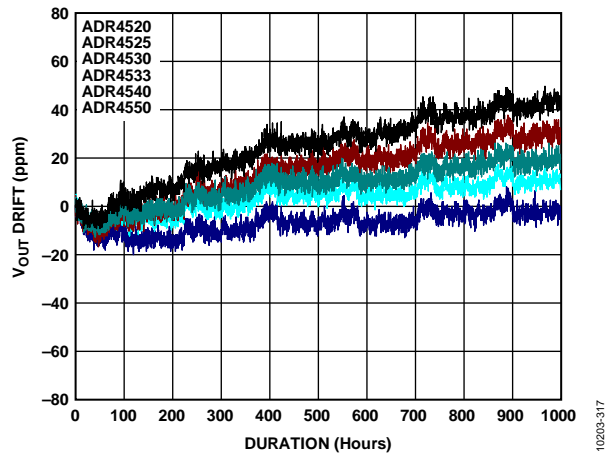

Figure 48. ADR4530 Typical Long-Term Output Voltage Drift (1000 Hours)

ADR4533

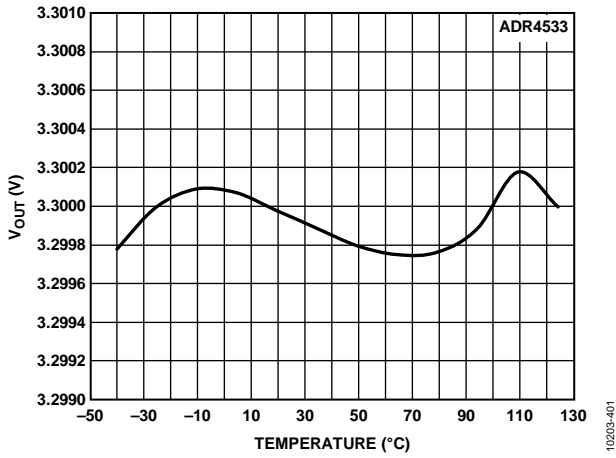

Figure 49. ADR4533 Output Voltage vs. Temperature

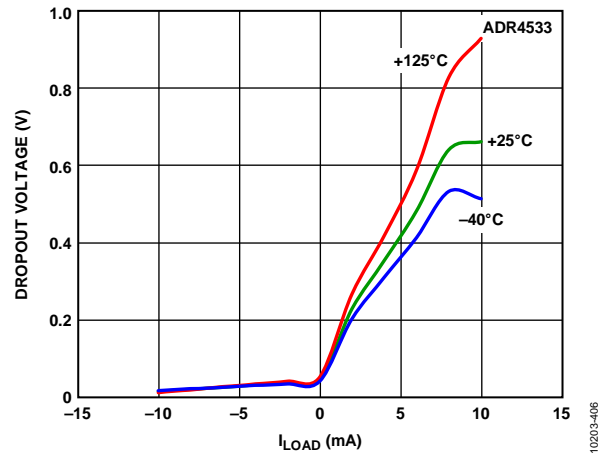

Figure 52. ADR4533 Dropout Voltage vs. Load Current

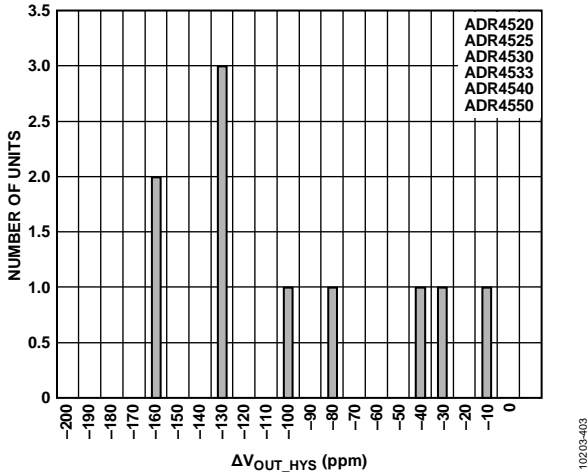

Figure 50. ADR4533 Thermally Induced Output Voltage Hysteresis Distribution

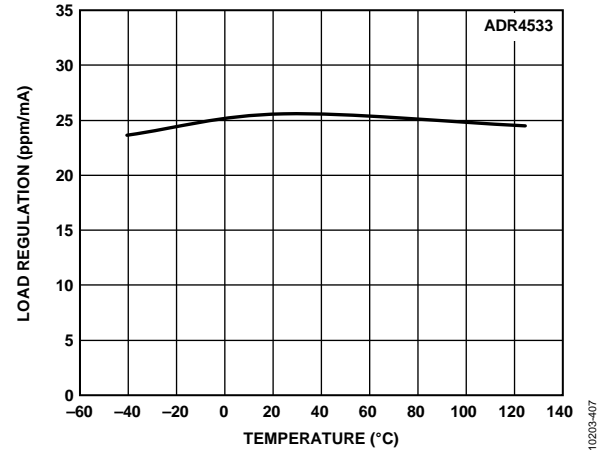

Figure 53. ADR4533 Load Regulation vs. Temperature (Sourcing)

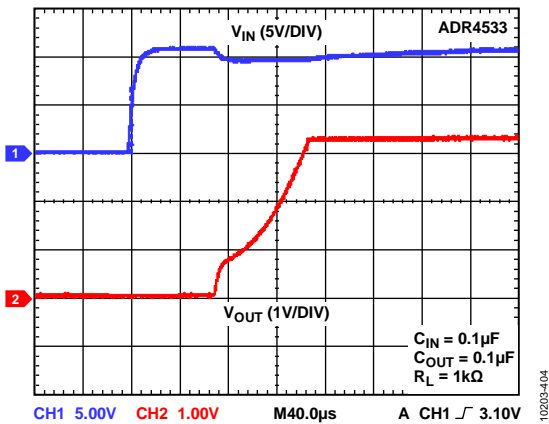

Figure 51. ADR4533 Output Voltage Start-Up Response

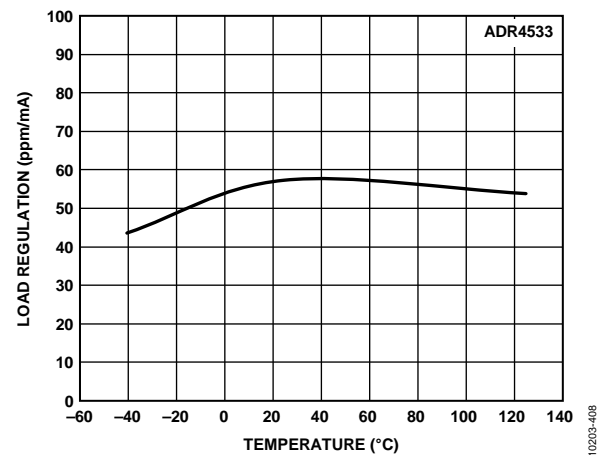

Figure 54. ADR4533 Load Regulation vs. Temperature (Sinking)

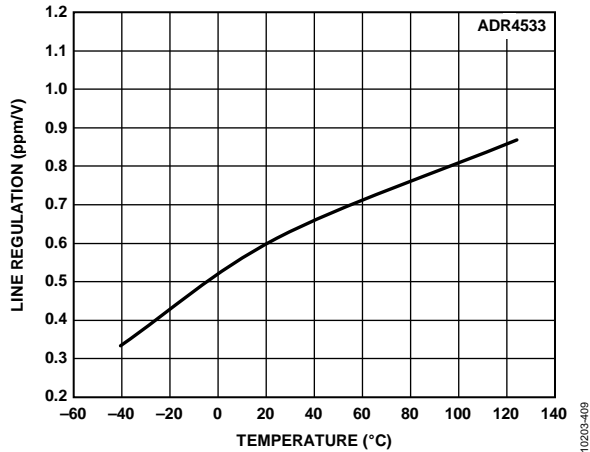

Figure 55. ADR4533 Line Regulation vs. Temperature

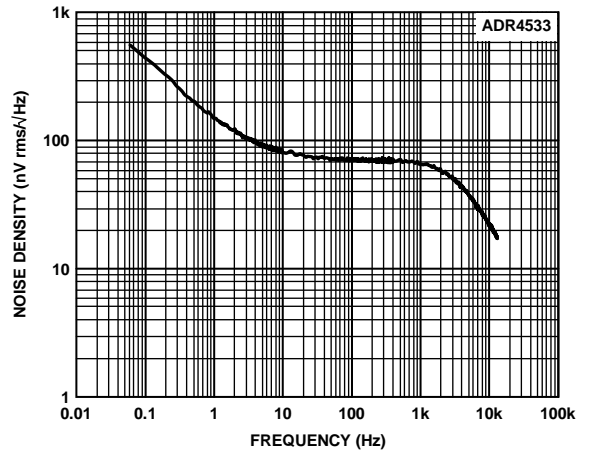

Figure 58. ADR4533 Output Noise Spectral Density

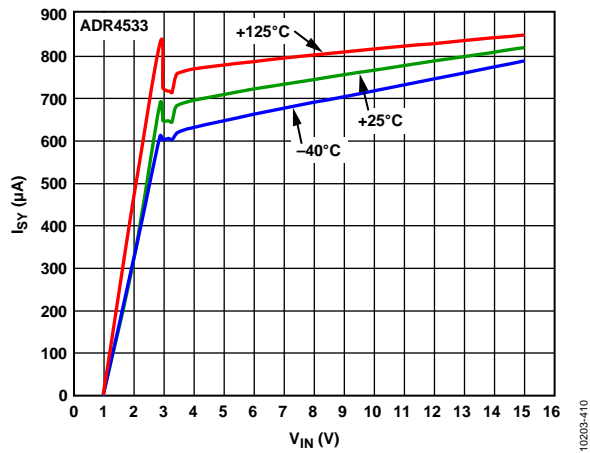

Figure 56. ADR4533 Supply Current vs. Supply Voltage

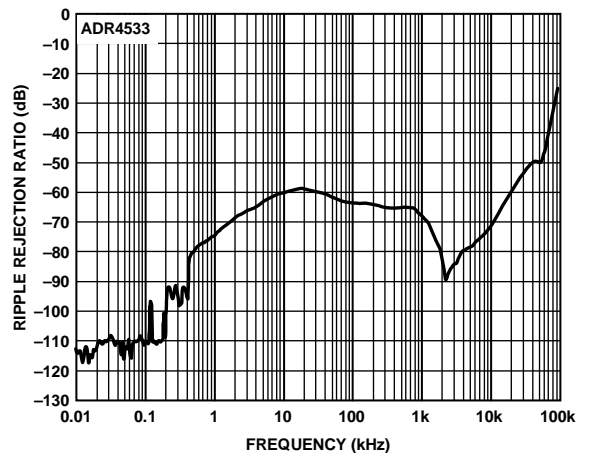

Figure 59. ADR4533 Ripple Rejection Ratio vs. Frequency

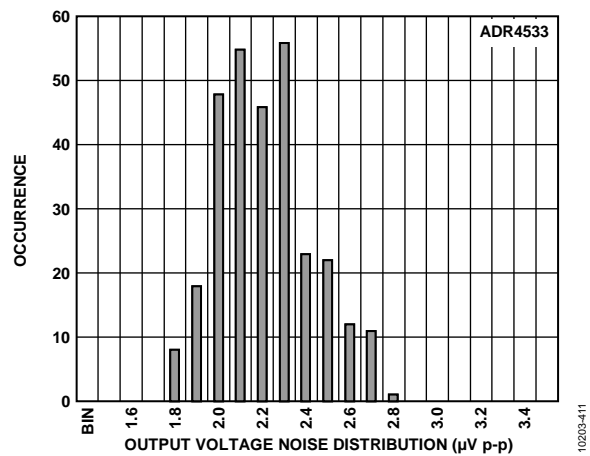

Figure 57. ADR4533 Output Voltage Noise (Maximum Amplitude from 0.1 Hz to 10 Hz)

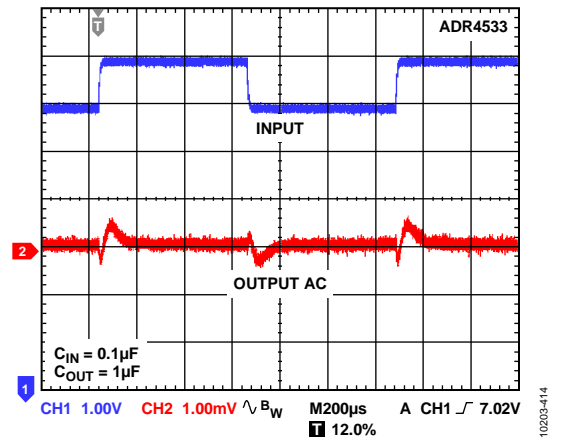

Figure 60. ADR4533 Line Transient Response

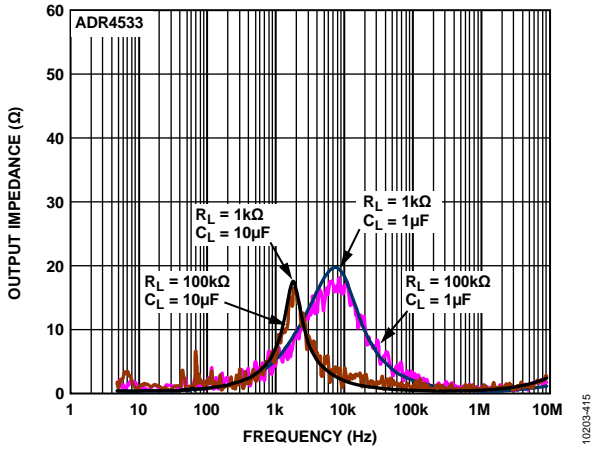

Figure 61. ADR4533 Output Impedance vs. Frequency

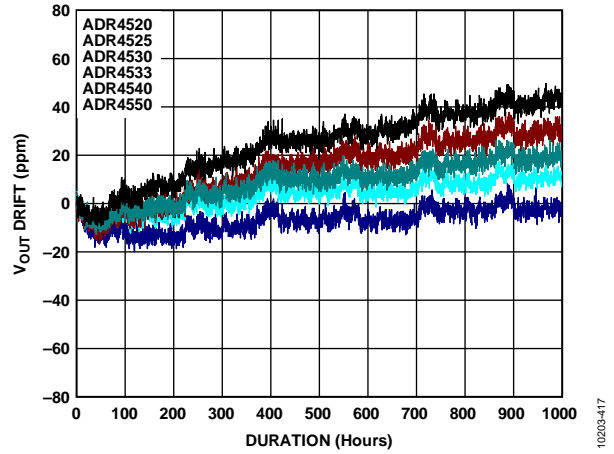

Figure 63. ADR4533 Typical Long-Term Output Voltage Drift (1000 Hours)

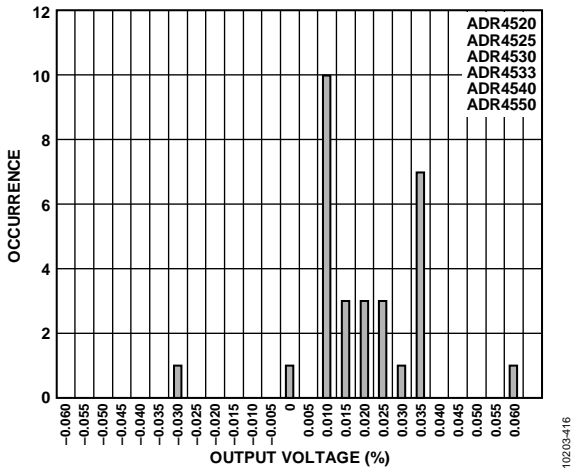

Figure 62. ADR4533 Output Voltage Drift Distribution After Reflow (SHR Drift)

10203-415

10203-417

10203-416

ADR4540

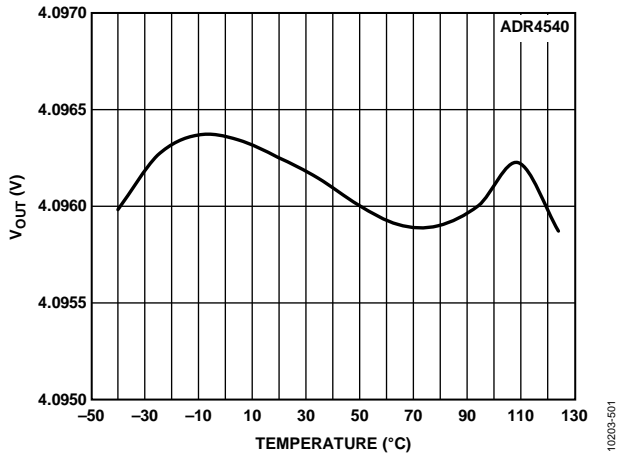

Figure 64. ADR4540 Output Voltage vs. Temperature

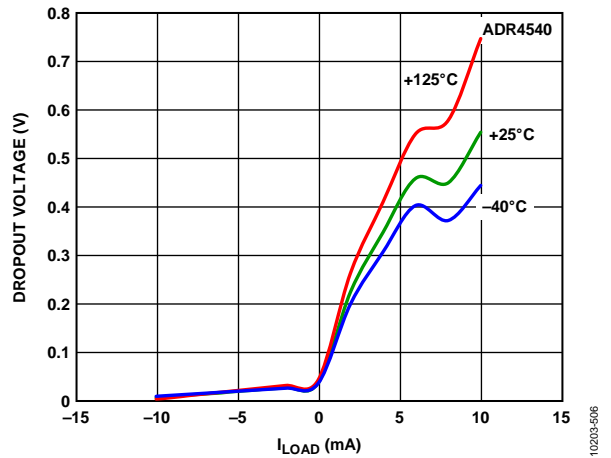

Figure 67. ADR4540 Dropout Voltage vs. Load Current

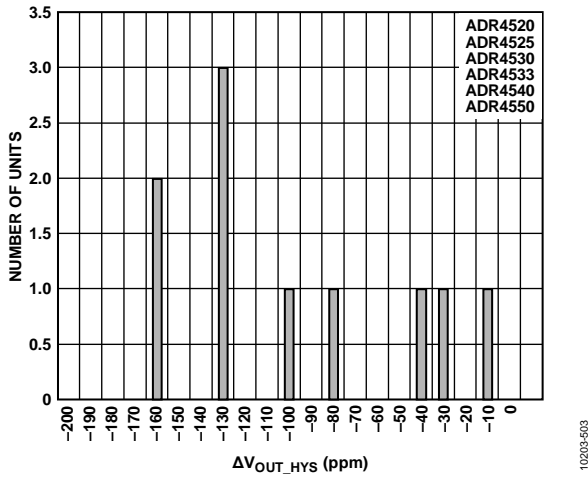

Figure 65. ADR4540 Thermally Induced Output Voltage Hysteresis Distribution

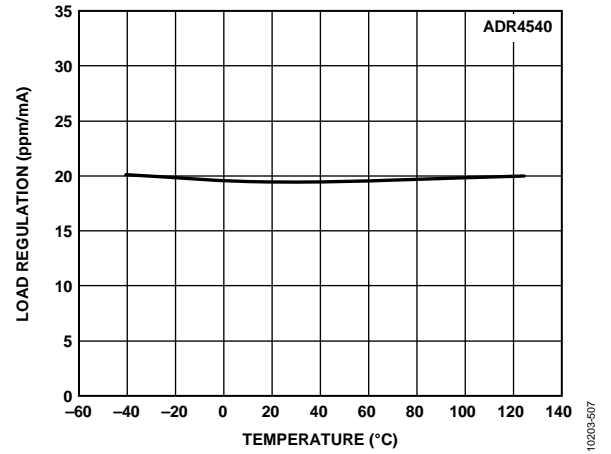

Figure 68. ADR4540 Load Regulation vs. Temperature (Sourcing)

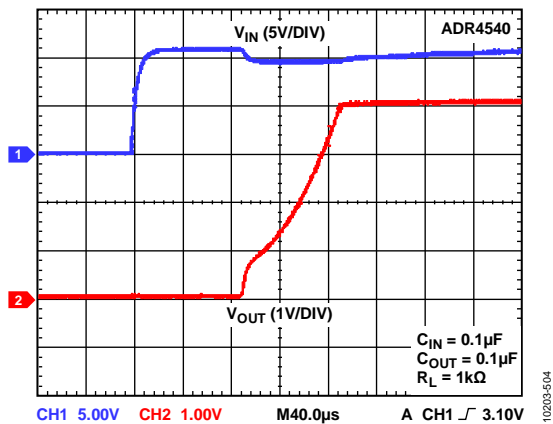

Figure 66. ADR4540 Output Voltage Start-Up Response

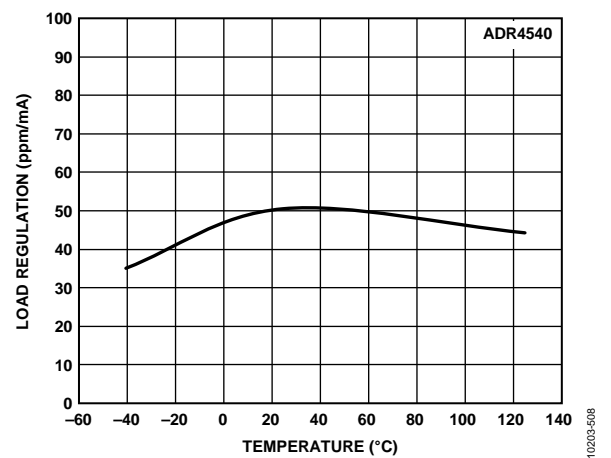

Figure 69. ADR4540 Load Regulation vs. Temperature (Sinking)

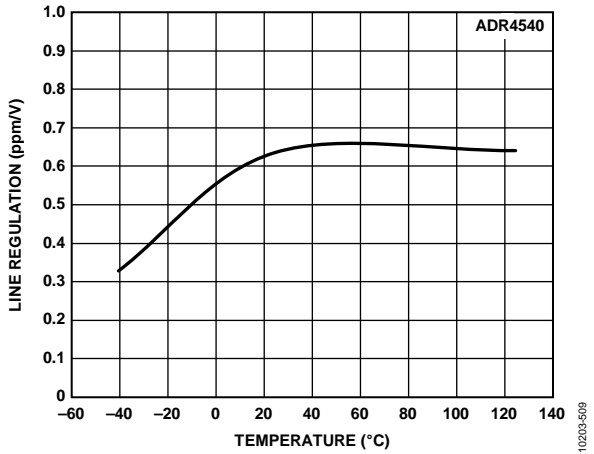

Figure 70. ADR4540 Line Regulation vs. Temperature

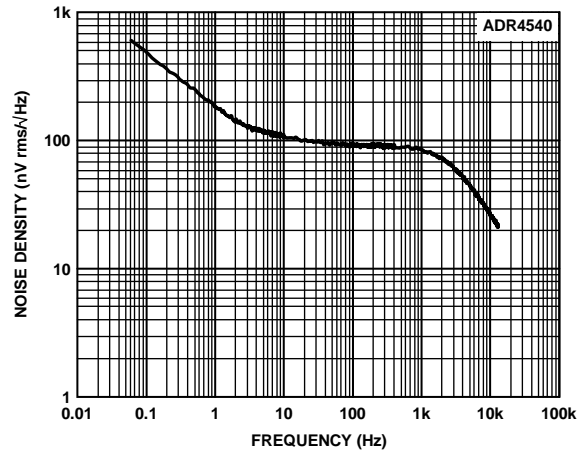

Figure 73. ADR4540 Output Noise Spectral Density

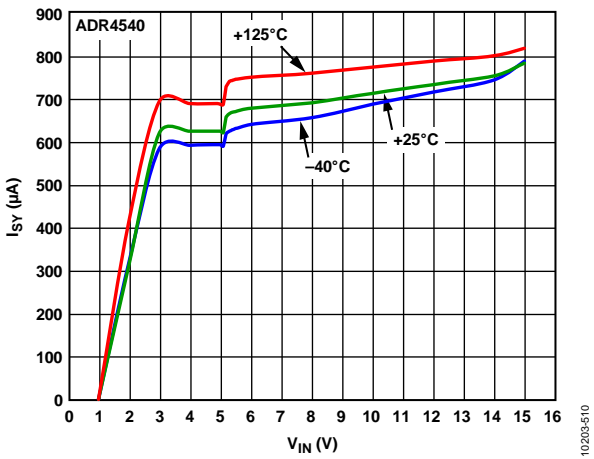

Figure 71. ADR4540 Supply Current vs. Supply Voltage

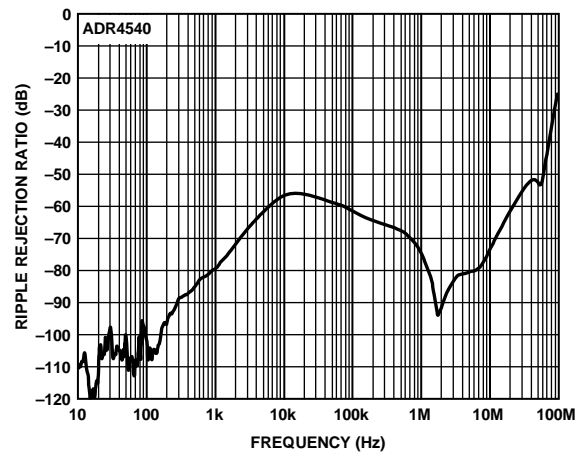

Figure 74. ADR4540 Ripple Rejection Ratio vs. Frequency

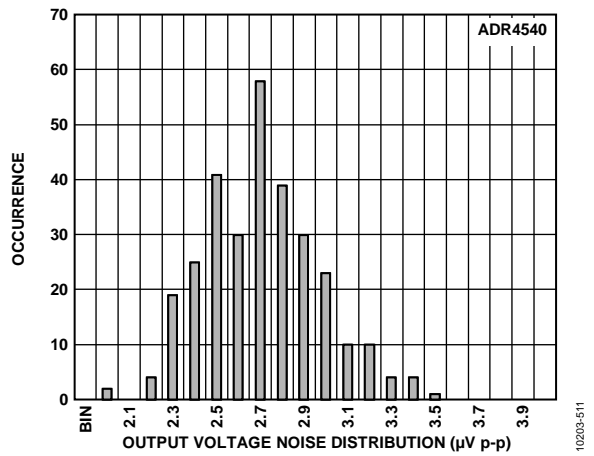

Figure 72. ADR4540 Output Voltage Noise (Maximum Amplitude from 0.1 Hz to 10 Hz)

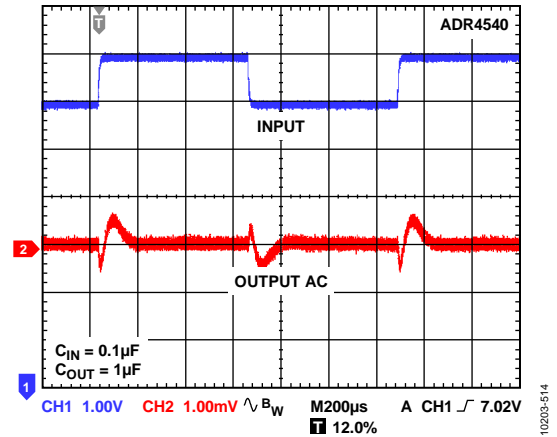

Figure 75. ADR4540 Line Transient Response

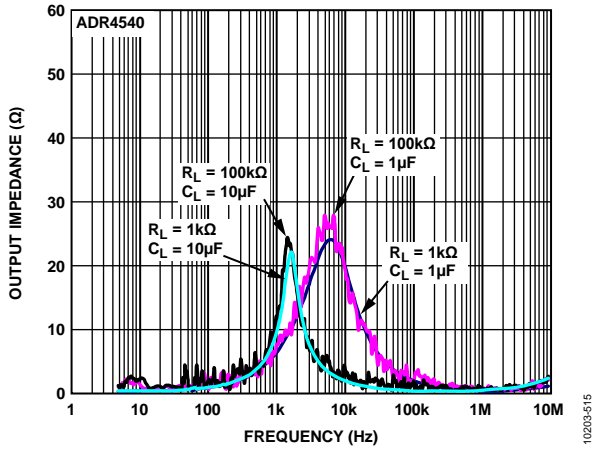

Figure 76. ADR4540 Output Impedance vs. Frequency

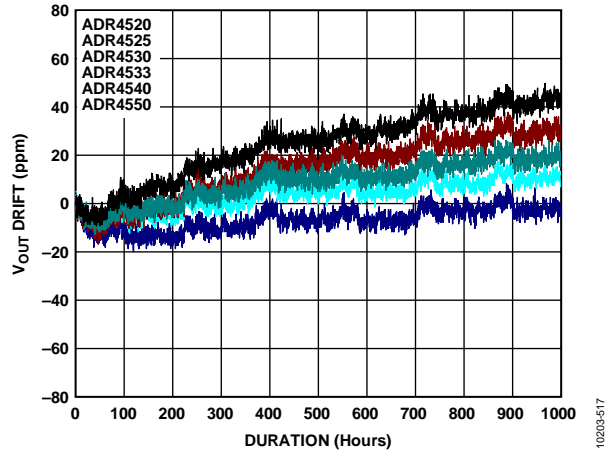

Figure 78. ADR4540 Typical Long-Term Output Voltage Drift (1000 Hours)

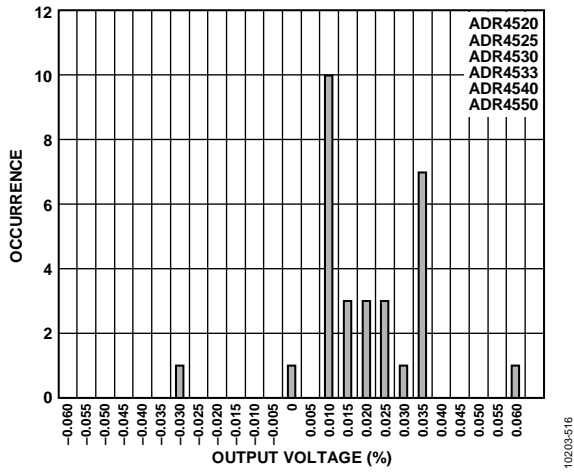

Figure 77. ADR4540 Output Voltage Drift Distribution After Reflow (SHR Drift)

10203-515

10203-517

10203-516

ADR4550

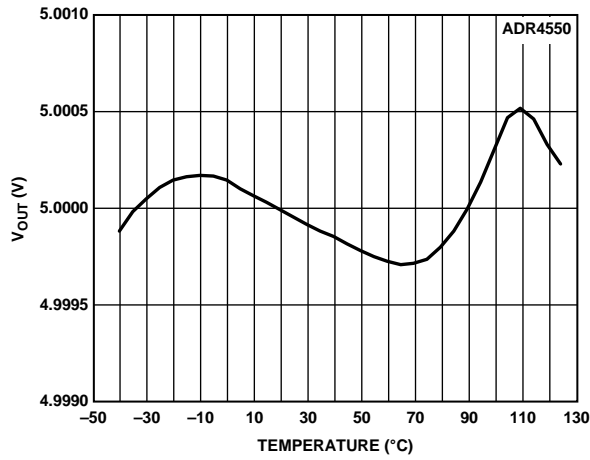

Figure 79. ADR4550 Output Voltage vs. Temperature

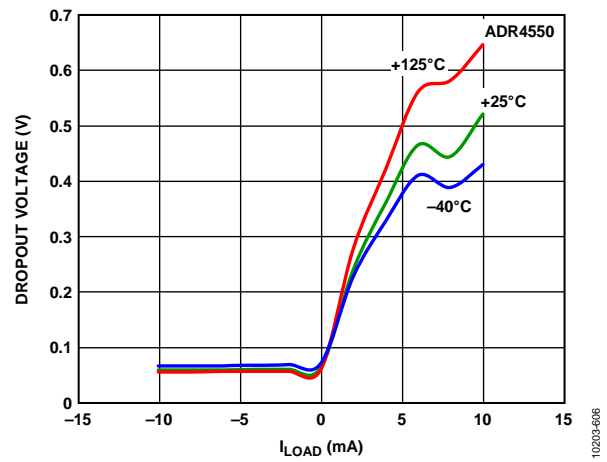

Figure 82. ADR4550 Dropout Voltage vs. Load Current

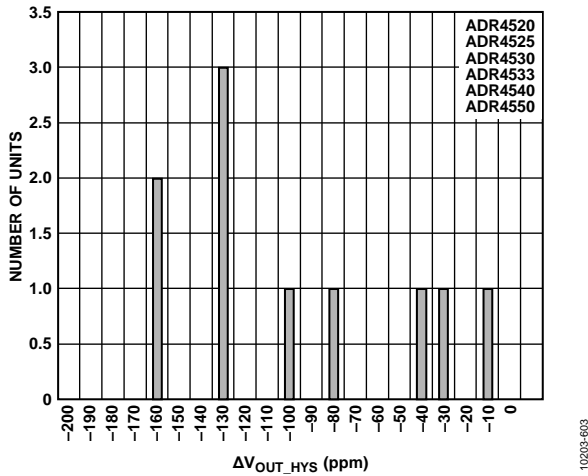

Figure 80. ADR4550 Thermally Induced Output Voltage Hysteresis Distribution

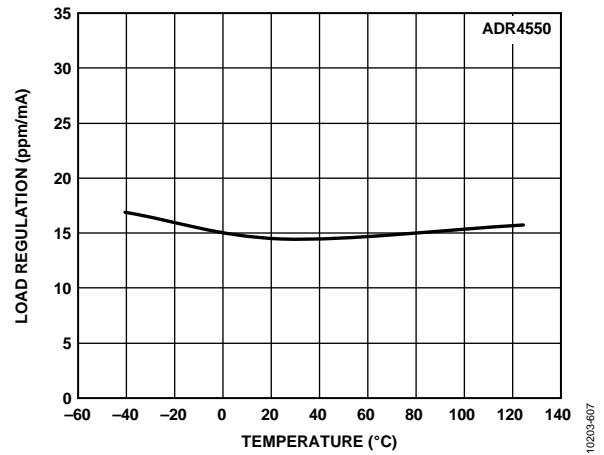

Figure 83. ADR4550 Load Regulation vs. Temperature (Sourcing)

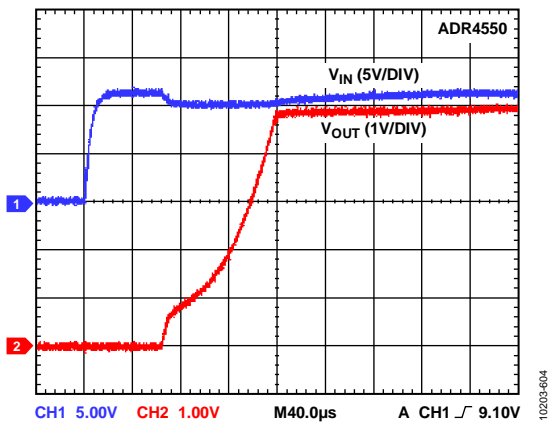

Figure 81. ADR4550 Output Voltage Start-Up Response

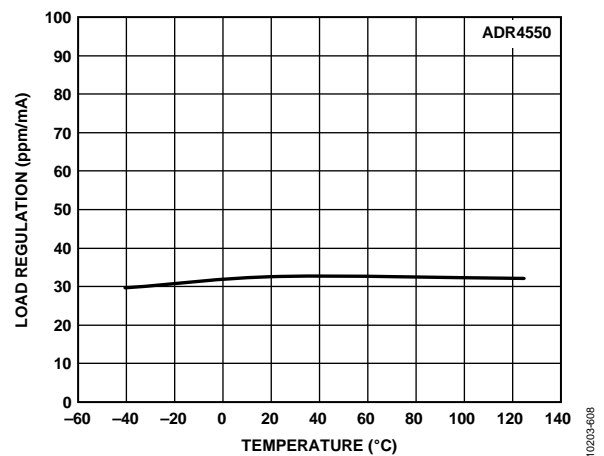

Figure 84. ADR4550 Load Regulation vs. Temperature (Sinking)

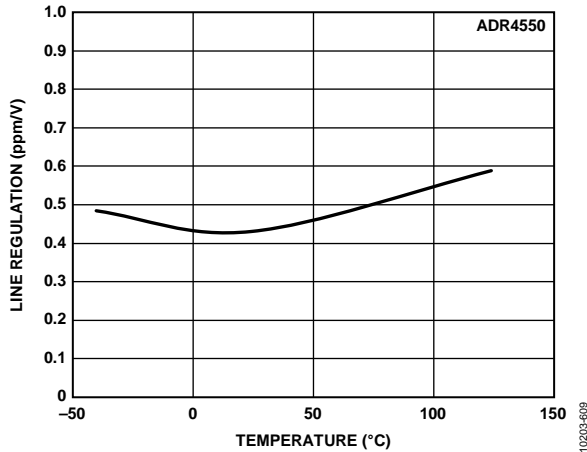

Figure 85. ADR4550 Line Regulation vs. Temperature

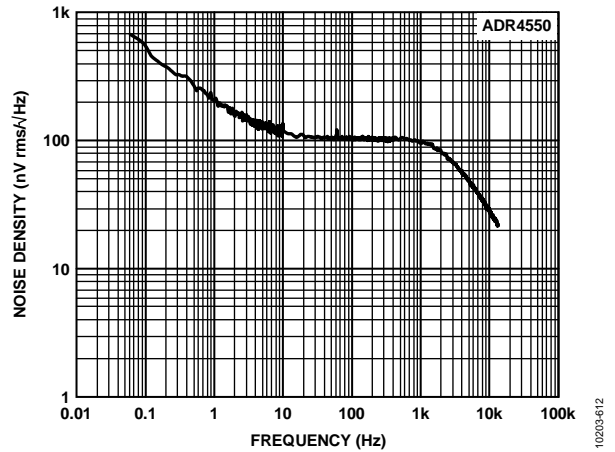

Figure 88. ADR4550 Output Noise Spectral Density

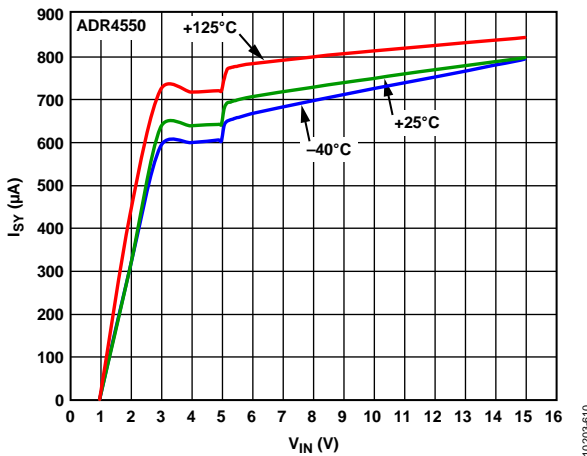

Figure 86. ADR4550 Supply Current vs. Supply Voltage

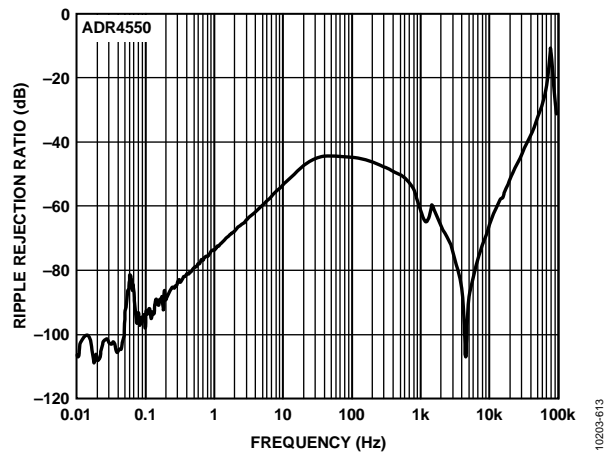

Figure 89. ADR4550 Ripple Rejection Ratio vs. Frequency

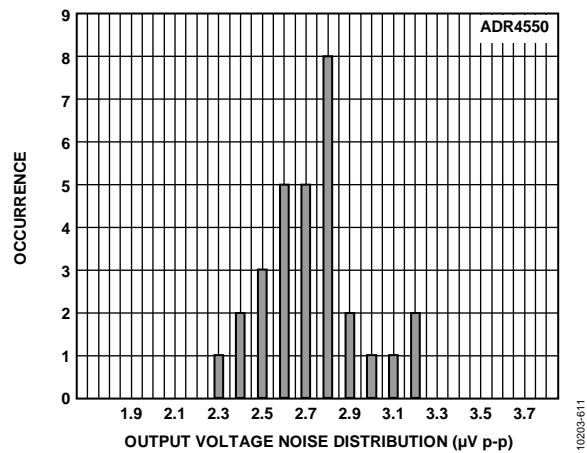

Figure 87. ADR4550 Output Voltage Noise (Maximum Amplitude from 0.1 Hz to 10 Hz)

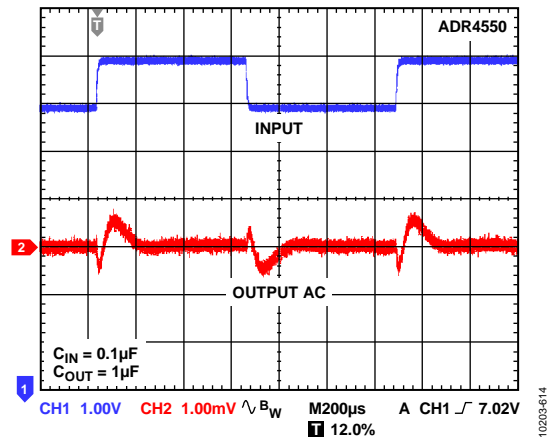

Figure 90. ADR4550 Line Transient Response

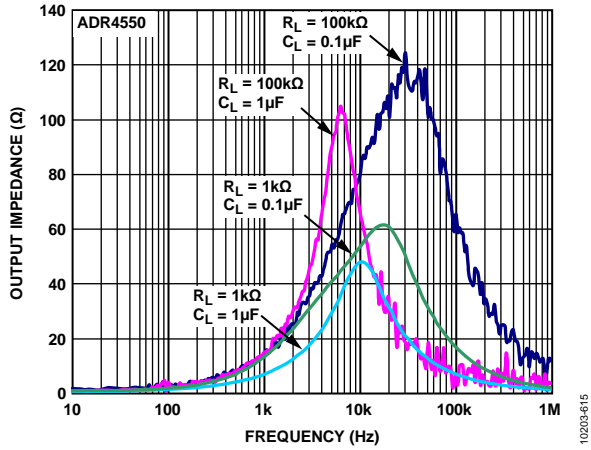

Figure 91. ADR4550 Output Impedance vs. Frequency

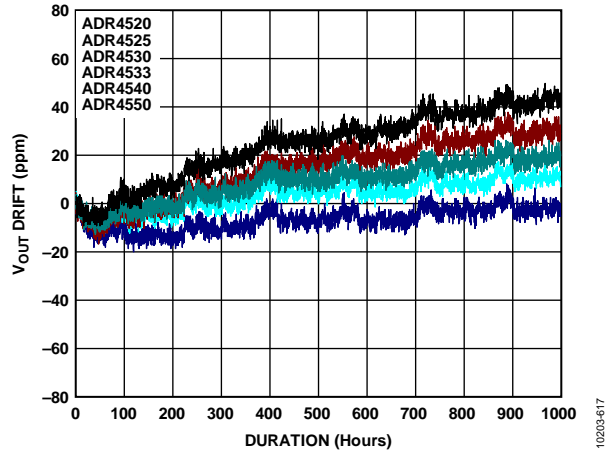

Figure 93. ADR4550 Typical Long-Term Output Voltage Drift (1000 Hours)

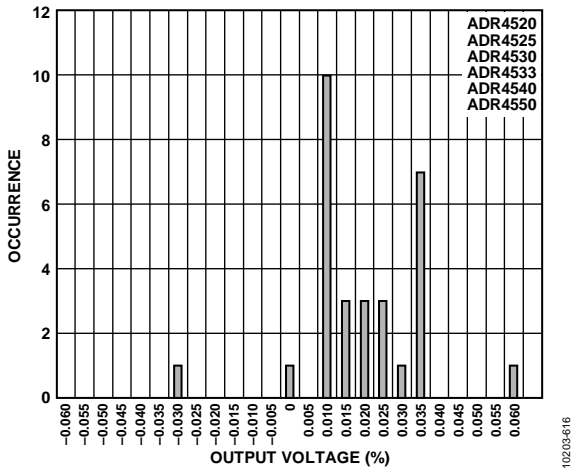

Figure 92. ADR4550 Output Voltage Drift Distribution After Reflow (SHR Drift)

TERMINOLOGY

Dropout Voltage (V_{DO})

Dropout voltage, sometimes referred to as supply voltage headroom or supply output voltage differential, is defined as the minimum voltage differential between the input and output such that the output voltage is maintained to within 0.1% accuracy.

$$V_{DO} = (V_{IN} - V_{OUT})_{min}|_{L = constant}$$

Because the dropout voltage depends on the current passing through the device, it is always specified for a given load current. In series mode devices, the dropout voltage typically increases proportionally to the load current (see Figure 6, Figure 21, Figure 37, Figure 52, Figure 67, and Figure 82).

Temperature Coefficient (TCV_{OUT})

The temperature coefficient relates the change in the output voltage to the change in the ambient temperature of the device, as normalized by the output voltage at 25°C. This parameter is determined by the box method, which is represented by the following equation:

$$TCV_{OUT} = \left| \frac{\max\{V_{OUT}(T_1, T_2, T_3)\} - \min\{V_{OUT}(T_1, T_2, T_3)\}}{V_{OUT}(T_2) \times (T_3 - T_1)} \right| \times 10^6$$

where:

TCV_{OUT} is expressed in ppm/°C.

$V_{OUT}(T_x)$ is the output voltage at Temperature T_x .

$T_1 = -40^\circ\text{C}$.

$T_2 = +25^\circ\text{C}$.

$T_3 = +125^\circ\text{C}$.

This three-point method ensures that TCV_{OUT} accurately portrays the maximum difference between any of the three temperatures at which the output voltage of the part is measured.

The TCV_{OUT} for the [ADR4520/ADR4525/ADR4530/ADR4533/ADR4540/ADR4550](#) is fully tested over three temperatures: -40°C , $+25^\circ\text{C}$, and $+125^\circ\text{C}$.

Thermally Induced Output Voltage Hysteresis (ΔV_{OUT_HYS})

Thermally induced output voltage hysteresis represents the change in the output voltage after the device is exposed to a specified temperature cycle. This is expressed as either a shift in voltage or a difference in ppm from the nominal output.

$$\Delta V_{OUT_HYS} = \frac{V_{OUT_25^\circ\text{C}} - V_{OUT_TC}}{V_{OUT_25^\circ\text{C}}} \times 10^6 \text{ [ppm]}$$

where:

$V_{OUT_25^\circ\text{C}}$ is the output voltage at 25°C.

V_{OUT_TC} is the output voltage after temperature cycling.

Long-Term Stability (ΔV_{OUT_LTD})

Long-term stability refers to the shift in the output voltage at 60°C after 1000 hours of operation in a 60°C environment. The ambient temperature is kept at 60°C to ensure that the temperature chamber does not switch randomly between heating and cooling, which can cause instability over the 1000 hour measurement. This is also expressed as either a shift in voltage or a difference in ppm from the nominal output.

$$\Delta V_{OUT_LTD} = \left| \frac{V_{OUT}(t_1) - V_{OUT}(t_0)}{V_{OUT}(t_0)} \right| \times 10^6 \text{ [ppm]}$$

where:

$V_{OUT}(t_0)$ is the V_{OUT} at 60°C at Time 0.

$V_{OUT}(t_1)$ is the V_{OUT} at 60°C after 1000 hours of operation at 60°C.

Line Regulation

Line regulation refers to the change in output voltage in response to a given change in input voltage and is expressed in percent per volt, ppm per volt, or μV per volt change in input voltage. This parameter accounts for the effects of self-heating.

Load Regulation

Load regulation refers to the change in output voltage in response to a given change in load current and is expressed in μV per mA, ppm per mA, or ohms of dc output resistance. This parameter accounts for the effects of self-heating.

Solder Heat Resistance (SHR) Shift

SHR shift refers to the permanent shift in output voltage that is induced by exposure to reflow soldering and is expressed in units of ppm. This shift is caused by changes in the stress exhibited on the die by the package materials when these materials are exposed to high temperatures. This effect is more pronounced in lead-free soldering processes due to higher reflow temperatures.

THEORY OF OPERATION

The [ADR4520/ADR4525/ADR4530/ADR4533/ADR4540/ADR4550](#) series of references uses a unique core topology for extremely high accuracy, stability, and noise performance.

Three parameters contribute to the accuracy of the dc output of a voltage reference: initial accuracy, temperature coefficient, and long-term drift. With an outstanding guaranteed initial error of 0.02% and a low temperature coefficient of 2 ppm/°C maximum, this series of voltage references is perfect for high precision applications. The industry-leading long-term stability of the devices means that systems need less frequent field calibration and that there is a reduction in the costly preshipment system burn-in time.

LONG-TERM DRIFT

One of the key parameters of the [ADR4520/ADR4525/ADR4530/ADR4533/ADR4540/ADR4550](#) references is long-term stability—the output drift over time that the device is powered up. Regardless of output voltage, internal testing during development showed a typical drift of approximately 25 ppm after 1000 hours of continuous, nonloaded operation in a 60°C extremely stable temperature controlled environment.

Note that the majority of the long-term drift typically occurs in the first 200 hours to 300 hours of operation. For systems that require highly stable output voltages over long periods of time, the designer should consider burning in the devices prior to use to minimize the amount of output drift exhibited by the reference over time. See the [AN-713 Application Note](#), *The*

Effect of Long-Term Drift on Voltage References, at www.analog.com for more information regarding the effects of long-term drift and how it can be minimized.

POWER DISSIPATION

The [ADR4520/ADR4525/ADR4530/ADR4533/ADR4540/ADR4550](#) voltage references are capable of sourcing and sinking up to 10 mA of load current at room temperature across the rated input voltage range. However, when used in applications subject to high ambient temperatures, the input voltage and load current should be carefully monitored to ensure that the device does not exceed its maximum power dissipation rating. The maximum power dissipation of the device can be calculated via the following equation:

$$P_D = \frac{T_J - T_A}{\theta_{JA}}$$

where:

P_D is the device power dissipation.

T_J is the device junction temperature.

T_A is the ambient temperature.

θ_{JA} is the package (junction-to-air) thermal resistance.

Due to this relationship, acceptable load current in high temperature conditions may be less than the maximum current sourcing capability of the device. In no case should the part be operated outside of its maximum power rating because doing so may result in premature failure or permanent damage to the device.

APPLICATIONS INFORMATION

BASIC VOLTAGE REFERENCE CONNECTION

The circuit shown in Figure 94 illustrates the basic configuration for the [ADR4520/ADR4525/ADR4530/ADR4533/ADR4540/ADR4550](#) family of voltage references.

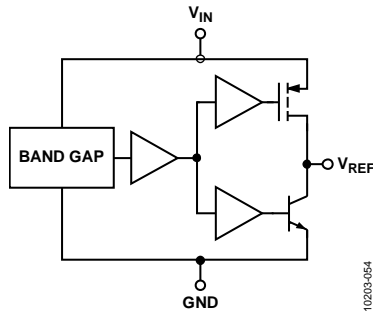

Figure 94. [ADR4520/ADR4525/ADR4530/ADR4533/ADR4540/ADR4550](#) Simplified Schematic

INPUT AND OUTPUT CAPACITORS

Input Capacitors

A 1 μF to 10 μF electrolytic or ceramic capacitor can be connected to the input to improve transient response in applications where the supply voltage may fluctuate. An additional 0.1 μF ceramic capacitor should be connected in parallel to reduce supply noise.

Output Capacitors

An output capacitor is required for stability and to filter out low level voltage noise. The minimum value of the output capacitor is shown in Table 12.

Table 12. Minimum C_{OUT} Value

Part Number	Minimum C_{OUT} Value
ADR4520, ADR4525	1.0 μF
ADR4530, ADR4533, ADR4540, ADR4550	0.1 μF

An additional 1 μF to 10 μF electrolytic or ceramic capacitor can be added in parallel to improve transient performance in response to sudden changes in load current; however, the designer should keep in mind that doing so will increase the turn-on time of the device.

LOCATION OF REFERENCE IN SYSTEM

The [ADR4520/ADR4525/ADR4530/ADR4533/ADR4540/ADR4550](#) reference should be placed as close to the load as possible to minimize the length of the output traces and, therefore, the error introduced by the voltage drop. Current flowing through a PCB trace produces an IR voltage drop; with longer traces, this drop can reach several millivolts or more, introducing considerable error into the output voltage of the reference. A 1 inch long, 5 mm wide trace of 1 ounce copper has a resistance of approximately 100 m Ω at room temperature; at a load current of 10 mA, this can introduce a full millivolt of error.

SAMPLE APPLICATIONS

Bipolar Output Reference

Figure 95 shows a bipolar reference configuration. By connecting the output of the [ADR4550](#) to the inverting terminal of an operational amplifier, it is possible to obtain both positive and negative reference voltages. R1 and R2 must be matched as closely as possible to ensure minimal difference between the negative and positive outputs. Resistors with low temperature coefficients must also be used if the circuit is used in environments with large temperature swings; otherwise, a voltage difference develops between the two outputs as the ambient temperature changes.

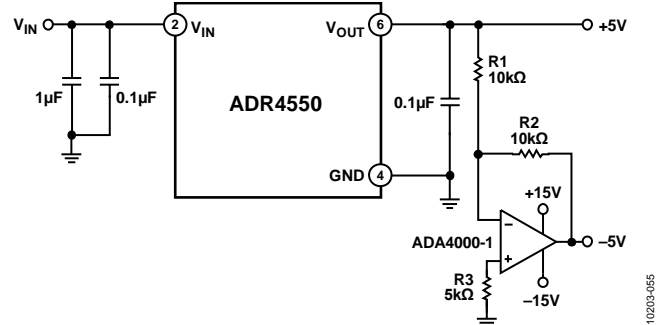

Figure 95. [ADR4550](#) Bipolar Output Reference

Boosted Output Current Reference

Figure 96 shows a configuration for obtaining higher current drive capability from the [ADR4520/ADR4525/ADR4530/ADR4533/ADR4540/ADR4550](#) references without sacrificing accuracy. The op amp regulates the current flow through the MOSFET until V_{OUT} equals the output voltage of the reference; current is then drawn directly from V_{IN} instead of from the reference itself, allowing increased current drive capability.

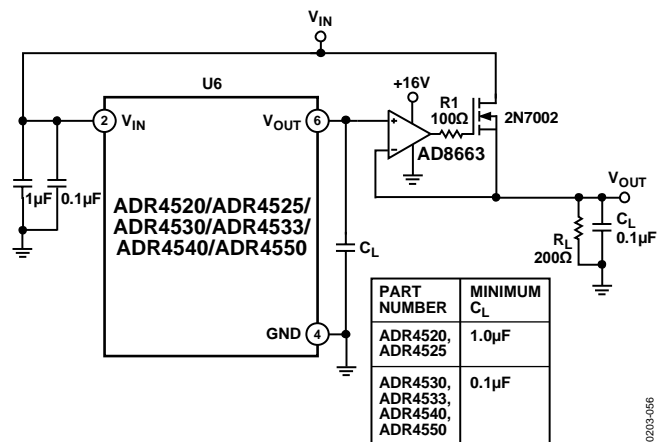
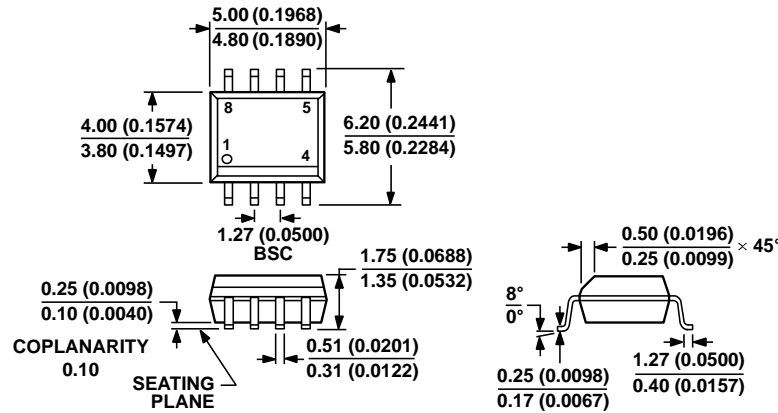

Figure 96. Boosted Output Current Reference

Because the current-sourcing capability of this circuit depends only on the I_D rating of the MOSFET, the output drive capability can be adjusted to the application simply by choosing an appropriate MOSFET. In all cases, the V_{OUT} pin should be tied directly to the load device to maintain maximum output voltage accuracy.

OUTLINE DIMENSIONS



COMPLIANT TO JEDEC STANDARDS MS-012-AA
 CONTROLLING DIMENSIONS ARE IN MILLIMETERS; INCH DIMENSIONS
 (IN PARENTHESES) ARE ROUNDED-OFF MILLIMETER EQUIVALENTS FOR
 REFERENCE ONLY AND ARE NOT APPROPRIATE FOR USE IN DESIGN.

Figure 97. 8-Lead Standard Small Outline Package [SOIC_N]
 Narrow Body
 (R-8)

Dimensions shown in millimeters and (inches)

012407-A

ORDERING GUIDE

Model ¹	Temperature Range	Package Description	Package Option	Ordering Quantity
ADR4520ARZ	-40°C to +125°C	8-Lead SOIC_N	R-8	98
ADR4520ARZ-R7	-40°C to +125°C	8-Lead SOIC_N	R-8	1,000
ADR4520BRZ	-40°C to +125°C	8-Lead SOIC_N	R-8	98
ADR4520BRZ-R7	-40°C to +125°C	8-Lead SOIC_N	R-8	1,000
ADR4525ARZ	-40°C to +125°C	8-Lead SOIC_N	R-8	98
ADR4525ARZ-R7	-40°C to +125°C	8-Lead SOIC_N	R-8	1,000
ADR4525BRZ	-40°C to +125°C	8-Lead SOIC_N	R-8	98
ADR4525BRZ-R7	-40°C to +125°C	8-Lead SOIC_N	R-8	1,000
ADR4530ARZ	-40°C to +125°C	8-Lead SOIC_N	R-8	98
ADR4530ARZ-R7	-40°C to +125°C	8-Lead SOIC_N	R-8	1,000
ADR4530BRZ	-40°C to +125°C	8-Lead SOIC_N	R-8	98
ADR4530BRZ-R7	-40°C to +125°C	8-Lead SOIC_N	R-8	1,000
ADR4533ARZ	-40°C to +125°C	8-Lead SOIC_N	R-8	98
ADR4533ARZ-R7	-40°C to +125°C	8-Lead SOIC_N	R-8	1,000
ADR4533BRZ	-40°C to +125°C	8-Lead SOIC_N	R-8	98
ADR4533BRZ-R7	-40°C to +125°C	8-Lead SOIC_N	R-8	1,000
ADR4540ARZ	-40°C to +125°C	8-Lead SOIC_N	R-8	98
ADR4540ARZ-R7	-40°C to +125°C	8-Lead SOIC_N	R-8	1,000
ADR4540BRZ	-40°C to +125°C	8-Lead SOIC_N	R-8	98
ADR4540BRZ-R7	-40°C to +125°C	8-Lead SOIC_N	R-8	1,000
ADR4550ARZ	-40°C to +125°C	8-Lead SOIC_N	R-8	98
ADR4550ARZ-R7	-40°C to +125°C	8-Lead SOIC_N	R-8	1,000
ADR4550BRZ	-40°C to +125°C	8-Lead SOIC_N	R-8	98
ADR4550BRZ-R7	-40°C to +125°C	8-Lead SOIC_N	R-8	1,000

¹ Z = RoHS Compliant Part.

Mouser Electronics

Authorized Distributor

Click to View Pricing, Inventory, Delivery & Lifecycle Information:

Analog Devices Inc.:

[ADR4520ARZ](#) [ADR4550ARZ](#) [ADR4530BRZ](#) [ADR4550BRZ-R7](#) [ADR4550ARZ-R7](#) [ADR4525BRZ-R7](#)
[ADR4525ARZ-R7](#) [ADR4540ARZ](#) [ADR4540BRZ-R7](#) [ADR4533ARZ](#) [ADR4550BRZ](#) [ADR4530ARZ](#) [ADR4540BRZ](#)
[ADR4533ARZ-R7](#) [ADR4520BRZ-R7](#) [ADR4520ARZ-R7](#) [ADR4533BRZ](#) [ADR4530BRZ-R7](#) [ADR4540ARZ-R7](#)
[ADR4520BRZ](#) [ADR4525ARZ](#) [ADR4533BRZ-R7](#) [ADR4530ARZ-R7](#) [ADR4525BRZ](#)