

### FEATURES

- USB 1.1 signal switching compliant
- 3 dB bandwidth, 150 MHz
- Tiny 10-lead LFCSP and MSOP packages, 10-ball WLCSP package
- Single-supply 1.8 V to 5.5 V operation
- Low on resistance
  - 2.5  $\Omega$  typical
  - 3.45  $\Omega$  maximum at 85°C
- Typical power consumption: <0.1  $\mu$ W

### APPLICATIONS

- USB 1.1 signal switching circuits
- Cellular phones
- PDA's
- MP3 players
- Battery-powered systems
- Headphone switching
- Audio and video signal routing
- Communications systems

### GENERAL DESCRIPTION

The ADG787 is a low voltage, CMOS device that contains two independently selectable single-pole, double-throw (SPDT) switches. It is designed as a general analog-to-digital switch and can also be used for routing USB 1.1 signals.

This device offers low on resistance of typically 2.5  $\Omega$ , making the part an attractive solution for applications that require low distortion through the switch.

The ADG787 comes in a 10-ball WLCSP, a tiny 10-lead LFCSP, and a tiny 10-lead MSOP. These packages make the ADG787 the ideal solution for space-constrained applications.

Each switch conducts equally well in both directions when on and has an input signal range that extends to the supplies. The ADG787 exhibits break-before-make switching action.

### FUNCTIONAL BLOCK DIAGRAM

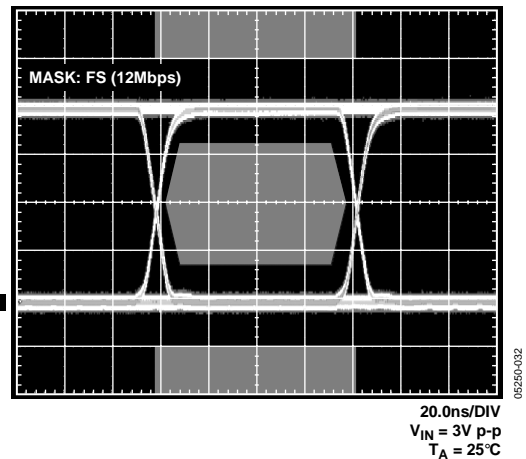
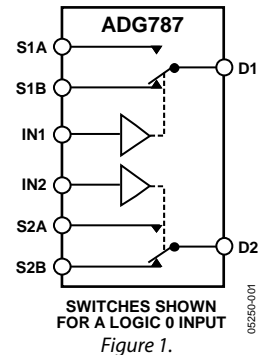

Figure 2. Eye Pattern; 12 Mbps,  $V_{DD} = 4.2$  V, PRBS 31

#### Rev. A

Information furnished by Analog Devices is believed to be accurate and reliable. However, no responsibility is assumed by Analog Devices for its use, nor for any infringements of patents or other rights of third parties that may result from its use. Specifications subject to change without notice. No license is granted by implication or otherwise under any patent or patent rights of Analog Devices. Trademarks and registered trademarks are the property of their respective owners.

**TABLE OF CONTENTS**

Features .....	1	Pin Configurations and Function Descriptions .....	6
Applications.....	1	Truth Table .....	6
Functional Block Diagram .....	1	Typical Performance Characteristics .....	7
General Description .....	1	Test Circuits .....	11
Specifications.....	3	Terminology .....	13
Absolute Maximum Ratings.....	5	Outline Dimensions .....	14
ESD Caution.....	5	Ordering Guide .....	15

**REVISION HISTORY**

**5/06—Rev. 0 to Rev. A**

Updated Formatting .....	Universal
Changes to Table 1 .....	3
Changes to Table 3 .....	5
Changes to Ordering Guide .....	15

**1/05—Revision 0: Initial Version**

## SPECIFICATIONS

$V_{DD} = 4.2 \text{ V to } 5.5 \text{ V}$ ,  $GND = 0 \text{ V}$ , unless otherwise noted.

**Table 1.**

Parameter	+25°C	B Version <sup>1</sup>	Unit	Test Conditions/Comments
<b>ANALOG SWITCH</b>				
Analog Signal Range		0 to $V_{DD}$	V	
On Resistance ( $R_{ON}$ )	2.5		$\Omega$ typ	$V_{DD} = 4.2 \text{ V}$ , $V_S = 0 \text{ V to } V_{DD}$ , $I_S = 10 \text{ mA}$
	3	3.45	$\Omega$ max	See Figure 28
On Resistance Match Between Channels ( $\Delta R_{ON}$ )	0.02		$\Omega$ typ	$V_{DD} = 4.2 \text{ V}$ , $V_S = 3.5 \text{ V}$ , $I_S = 10 \text{ mA}$
		0.1	$\Omega$ max	
On Resistance Flatness ( $R_{FLAT(ON)}$ )	0.65		$\Omega$ typ	$V_{DD} = 4.2 \text{ V}$ , $V_S = 0 \text{ V to } V_{DD}$
	0.8	0.95	$\Omega$ max	$I_S = 10 \text{ mA}$
<b>LEAKAGE CURRENTS</b>				
Source Off Leakage, $I_S$ (OFF)	$\pm 0.05$		nA typ	$V_{DD} = 5.5 \text{ V}$ $V_S = 1 \text{ V}/4.5 \text{ V}$ , $V_D = 4.5 \text{ V}/1 \text{ V}$ ; see Figure 29
Channel On Leakage, $I_D$ , $I_S$ (ON)	$\pm 0.05$		nA typ	$V_S = V_D = 1 \text{ V or } 4.5 \text{ V}$ ; see Figure 30
<b>DIGITAL INPUTS</b>				
Input High Voltage, $V_{INH}$		2.0	V min	
Input Low Voltage, $V_{INL}$		0.8	V max	
Input Current $I_{INL}$ or $I_{INH}$	0.005		$\mu\text{A}$ typ	$V_{IN} = V_{INL}$ or $V_{INH}$
		$\pm 0.1$	$\mu\text{A}$ max	
$C_{IN}$ , Digital Input Capacitance	2.5		pF typ	
<b>DYNAMIC CHARACTERISTICS<sup>2</sup></b>				
$t_{ON}$	13		ns typ	$R_L = 50 \Omega$ , $C_L = 35 \text{ pF}$
	19	22	ns max	$V_S = 3 \text{ V}$ ; see Figure 31
$t_{OFF}$	3		ns typ	$R_L = 50 \Omega$ , $C_L = 35 \text{ pF}$
	5	6	ns max	$V_S = 3 \text{ V}$ ; see Figure 31
Propagation Delay Skew, $t_{SKEW}$	0.06		ns typ	$C_L = 50 \text{ pF}$ ; $V_S = 3 \text{ V}$
		0.15	ns max	
Break-Before-Make Time Delay ( $t_{BBM}$ )	10		ns typ	$R_L = 50 \Omega$ , $C_L = 35 \text{ pF}$
		5	ns min	$V_{S1} = V_{S2} = 3 \text{ V}$ ; see Figure 32
Charge Injection	14		pC typ	$V_D = 1 \text{ V}$ , $R_S = 0 \Omega$ , $C_L = 1 \text{ nF}$ ; see Figure 33
Off Isolation	-63		dB typ	$R_L = 50 \Omega$ , $C_L = 5 \text{ pF}$ , $f = 1 \text{ MHz}$ ; see Figure 34
Channel-to-Channel Crosstalk	-110		dB typ	S1A to S2A/S1B to S2B; $R_L = 50 \Omega$ , $C_L = 5 \text{ pF}$ , $f = 1 \text{ MHz}$ ; see Figure 37
			dB typ	S1A to S1B/S2A to S2B; $R_L = 50 \Omega$ , $C_L = 5 \text{ pF}$ , $f = 1 \text{ MHz}$ ; see Figure 36
Total Harmonic Distortion (THD + N)	0.03		%	$R_L = 32 \Omega$ , $f = 20 \text{ Hz to } 20 \text{ kHz}$ , $V_S = 2 \text{ V p-p}$
Insertion Loss	-0.2		dB typ	$R_L = 50 \Omega$ , $C_L = 5 \text{ pF}$ ; see Figure 36
-3 dB Bandwidth	145		MHz typ	$R_L = 50 \Omega$ , $C_L = 5 \text{ pF}$ ; see Figure 36
$C_S$ (OFF)	16		pF typ	
$C_D$ , $C_S$ (ON)	40		pF typ	
<b>POWER REQUIREMENTS</b>				
$I_{DD}$	0.005		$\mu\text{A}$ typ	$V_{DD} = 5.5 \text{ V}$ Digital inputs = 0 V or 5.5 V
		1	$\mu\text{A}$ max	

<sup>1</sup> Temperature ranges: B version:  $-40^\circ\text{C}$  to  $+85^\circ\text{C}$  for the MSOP and LFCSF packages, and  $-25^\circ\text{C}$  to  $+85^\circ\text{C}$  for the WLCSP package.

<sup>2</sup> Guaranteed by design, not production tested.

# ADG787

$V_{DD} = 2.7\text{ V to }3.6\text{ V}$ ,  $GND = 0\text{ V}$ , unless otherwise noted.

**Table 2.**

Parameter	+25°C	B Version <sup>1</sup>	Unit	Test Conditions/Comments
<b>ANALOG SWITCH</b>				
Analog Signal Range			V	
On Resistance ( $R_{ON}$ )	4		$\Omega$ typ	$V_{DD} = 2.7\text{ V}$ , $V_S = 0\text{ V to }V_{DD}$
	5.75	6	$\Omega$ max	$I_S = 10\text{ mA}$ ; see Figure 28
On Resistance Match Between Channels ( $\Delta R_{ON}$ )	0.07		$\Omega$ typ	$V_{DD} = 2.7\text{ V}$ , $V_S = 1.5\text{ V}$
	0.3	0.35	$\Omega$ max	$I_S = 10\text{ mA}$
On Resistance Flatness ( $R_{FLAT(ON)}$ )	1.6		$\Omega$ typ	$V_{DD} = 2.7\text{ V}$ , $V_S = 0\text{ V to }V_{DD}$
	2.3	2.6	$\Omega$ max	$I_S = 10\text{ mA}$
<b>LEAKAGE CURRENTS</b>				
Source Off Leakage, $I_S$ (OFF)	$\pm 0.01$		nA typ	$V_{DD} = 3.6\text{ V}$
Channel On Leakage, $I_D$ , $I_S$ (ON)	$\pm 0.01$		nA typ	$V_S = 0.6\text{ V}/3.3\text{ V}$ , $V_D = 3.3\text{ V}/0.6\text{ V}$ ; see Figure 29
<b>DIGITAL INPUTS</b>				
Input High Voltage, $V_{INH}$		1.3	V min	
Input Low Voltage, $V_{INL}$		0.8	V max	
Input Current				
$I_{INL}$ or $I_{INH}$	0.005		$\mu\text{A}$ typ	$V_{IN} = V_{INL}$ or $V_{INH}$
		$\pm 0.1$	$\mu\text{A}$ max	
$C_{IN}$ , Digital Input Capacitance	2		pF typ	
<b>DYNAMIC CHARACTERISTICS<sup>2</sup></b>				
$t_{ON}$	18		ns typ	$R_L = 50\ \Omega$ , $C_L = 35\text{ pF}$
	30	35	ns max	$V_S = 1.5\text{ V}$ ; see Figure 31
$t_{OFF}$	4		ns typ	$R_L = 50\ \Omega$ , $C_L = 35\text{ pF}$
	6	7	ns max	$V_S = 1.5\text{ V}$ ; see Figure 31
Propagation Delay Skew, $t_{SKEW}$	0.04		ns typ	$C_L = 50\text{ pF}$ ; $V_S = 1.5\text{ V}$
		0.12	ns max	
Break-Before-Make Time Delay ( $t_{BBM}$ )	15		ns typ	$R_L = 50\ \Omega$ , $C_L = 35\text{ pF}$
		5	ns min	$V_{S1} = V_{S2} = 1.5\text{ V}$ ; see Figure 32
Charge Injection	10		pC typ	$V_D = 1.25\text{ V}$ , $R_S = 0\ \Omega$ , $C_L = 1\text{ nF}$ ; see Figure 33
Off Isolation	-63		dB typ	$R_L = 50\ \Omega$ , $C_L = 5\text{ pF}$ , $f = 1\text{ MHz}$ ; see Figure 34
Channel-to-Channel Crosstalk	-110		dB typ	S1A to S2A/S1B to S2B; $R_L = 50\ \Omega$ , $C_L = 5\text{ pF}$ , $f = 1\text{ MHz}$ ; see Figure 37
	-63		dB typ	S1A to S1B/S2A to S2B; $R_L = 50\ \Omega$ , $C_L = 5\text{ pF}$ , $f = 1\text{ MHz}$ ; see Figure 35
Total Harmonic Distortion (THD + N)	0.07		%	$R_L = 32\ \Omega$ , $f = 20\text{ Hz to }20\text{ kHz}$ , $V_S = 1.5\text{ V p-p}$
Insertion Loss	-0.24		dB typ	$R_L = 50\ \Omega$ , $C_L = 5\text{ pF}$ ; see Figure 36
-3 dB Bandwidth	145		MHz typ	$R_L = 50\ \Omega$ , $C_L = 5\text{ pF}$ ; see Figure 36
$C_S$ (OFF)	16		pF typ	
$C_D$ , $C_S$ (ON)	40		pF typ	
<b>POWER REQUIREMENTS</b>				
$I_{DD}$	0.005		$\mu\text{A}$ typ	$V_{DD} = 3.6\text{ V}$
		1	$\mu\text{A}$ max	Digital inputs = 0 V or 3.6 V

<sup>1</sup> Temperature range: B version:  $-40^\circ\text{C}$  to  $+85^\circ\text{C}$  for the MSOP and LFCSP packages, and  $-25^\circ\text{C}$  to  $+85^\circ\text{C}$  for the WLCSPP package.

<sup>2</sup> Guaranteed by design, not production tested.

## ABSOLUTE MAXIMUM RATINGS

$T_A = 25^\circ\text{C}$ , unless otherwise noted.

**Table 3.**

Parameter	Rating
$V_{DD}$ to GND	-0.3 V to +6 V
Analog Inputs <sup>1</sup> , Digital Inputs	-0.3 V to $V_{DD} + 0.3$ V or 30 mA (whichever occurs first)
Peak Current, S or D	
5 V Operation	300 mA
3.3 V Operation	200 mA (pulsed at 1 ms, 10% duty cycle max)
Continuous Current, S or D	
5 V Operation	100 mA
3.3 V Operation	80 mA
Operating Temperature Range	
Extended Industrial (B Version) MSOP and LFCSP packages	-40°C to +85°C
Industrial (B version) WLCSP package	-25°C to +85°C
Storage Temperature Range	-65°C to +150°C
Junction Temperature	150°C
WLCSP Package (4-Layer Board)	
$\theta_{JA}$ Thermal Impedance	120°C/W
LFCSP Package (4-Layer Board)	
$\theta_{JA}$ Thermal Impedance	61°C/W
MSOP Package (4-Layer Board)	
$\theta_{JA}$ Thermal Impedance	142°C/W
$\theta_{JC}$ Thermal Impedance	43.7°C/W
Lead-Free Temperature Soldering	
IR Reflow, Peak Temperature	
Peak Temperature	260(+0/-5)°C
Time at Peak Temperature	10 sec to 40 sec

<sup>1</sup> Overvoltages at the IN, S, or D pins are clamped by internal diodes. Current should be limited to the maximum ratings given.

Stresses above those listed under Absolute Maximum Ratings may cause permanent damage to the device. This is a stress rating only; functional operation of the device at these or any other conditions above those listed in the operational sections of this specification is not implied. Exposure to absolute maximum rating conditions for extended periods may affect device reliability.

Only one absolute maximum rating may be applied at any one time.

### ESD CAUTION

ESD (electrostatic discharge) sensitive device. Electrostatic charges as high as 4000 V readily accumulate on the human body and test equipment and can discharge without detection. Although this product features proprietary ESD protection circuitry, permanent damage may occur on devices subjected to high energy electrostatic discharges. Therefore, proper ESD precautions are recommended to avoid performance degradation or loss of functionality.



# ADG787

## PIN CONFIGURATIONS AND FUNCTION DESCRIPTIONS



Figure 3. 10-Lead LFCSP and 10-lead MSOP Pin Configuration

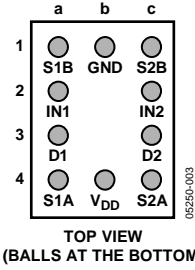

Figure 4. 10-Ball WLCSP Pin Configuration

Table 4. 10-Lead LFCSP/MSOP Pin Function Descriptions

Pin No.	Mnemonic	Description
1	V <sub>DD</sub>	Most Positive Power Supply Potential.
2	S1A	Source Terminal. May be an input or output.
3	D1	Drain Terminal. May be an input or output.
4	IN1	Logic Control Input.
5	S1B	Source Terminal. May be an input or output.
6	GND	Ground (0 V) Reference.
7	S2B	Source Terminal. May be an input or output.
8	IN2	Logic Control Input.
9	D2	Drain Terminal. May be an input or output.
10	S2A	Source Terminal. May be an input or output.

Table 5. 10-Lead WLCSP Pin Function Descriptions

Ball Location	Mnemonic	Description
1a	S1B	Source Terminal. May be an input or output.
1b	GND	Ground (0 V) Reference.
1c	S2B	Source Terminal. May be an input or output.
2a	IN1	Source Terminal. May be an input or output.
2c	IN2	Logic Control Input.
3a	D1	Drain Terminal. May be an input or output.
3c	D2	Drain Terminal. May be an input or output.
4a	S1A	Logic Control Input.
4b	V <sub>DD</sub>	Most Positive Power Supply Potential.
4c	S2A	Source Terminal. May be an input or output.

## TRUTH TABLE

Table 6.

Logic (IN1/IN2)	Switch 1A/2A	Switch 1B/2B
0	Off	On
1	On	Off

# TYPICAL PERFORMANCE CHARACTERISTICS



Figure 5. On Resistance vs.  $V_D$  ( $V_S$ ),  $V_{DD} = 4.2$  V to 5.5 V



Figure 8. On Resistance vs.  $V_D$  ( $V_S$ ) for Different Temperatures,  $V_{DD} = 4.2$  V



Figure 6. On Resistance vs.  $V_D$  ( $V_S$ ),  $V_{DD} = 2.7$  V to 3.6 V



Figure 9. On Resistance vs.  $V_D$  ( $V_S$ ) for Different Temperatures,  $V_{DD} = 3$  V



Figure 7. On Resistance vs.  $V_D$  ( $V_S$ ) for Different Temperatures,  $V_{DD} = 5$  V



Figure 10. Leakage Current vs. Temperature,  $V_{DD} = 5.5$  V



Figure 11. Leakage Current vs. Temperature,  $V_{DD} = 3.3 V$



Figure 14.  $t_{ON}/t_{OFF}$  Time vs. Temperature



Figure 12. Threshold Voltage vs. Supply



Figure 15. Bandwidth

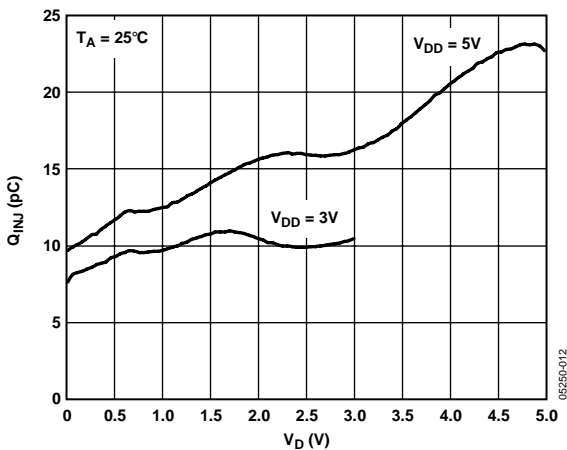

Figure 13. Charge Injection vs. Source Voltage

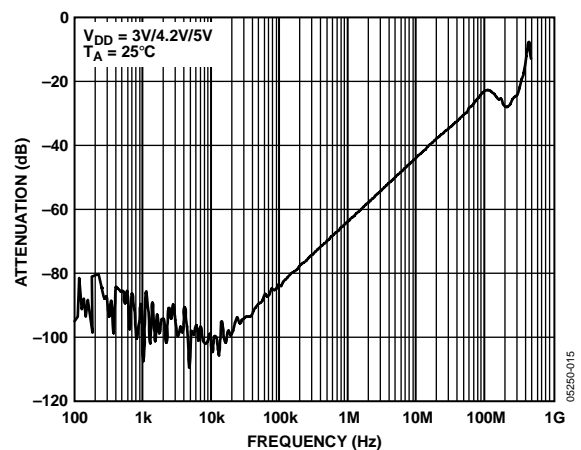

Figure 16. Off Isolation vs. Frequency





Figure 17. Crosstalk vs. Frequency



Figure 20. Rise/Fall Time Delay vs. Supply Voltage



Figure 18. AC Power Supply Rejection Ratio (PSRR)



Figure 21. Rise/Fall Time Delay vs. Temperature

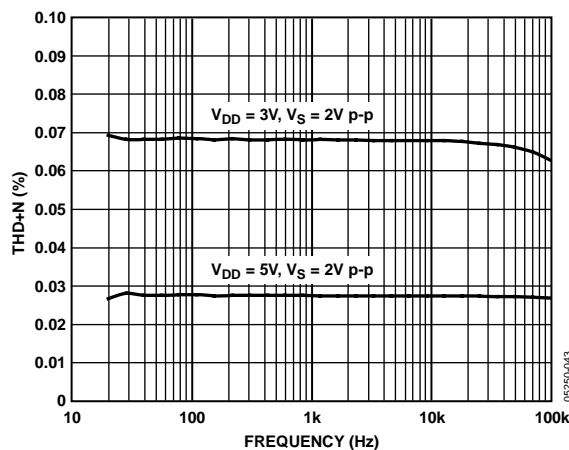

Figure 19. Total Harmonic Distortion + Noise

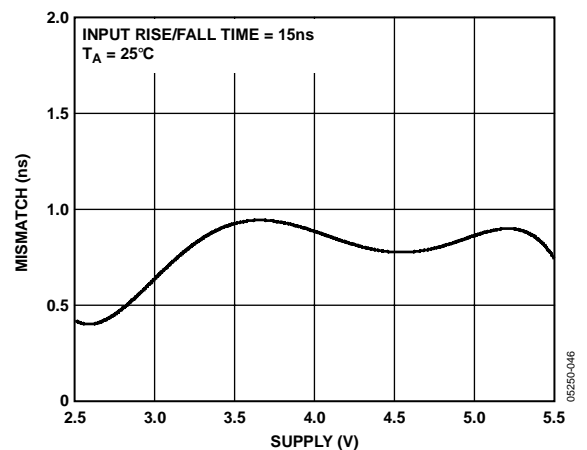

Figure 22. Rise-Time-to-Fall-Time Mismatch vs. Supply Voltage



Figure 23. Rise-Time-to-Fall-Time Mismatch vs. Temperature



Figure 24. Propagation Delay Skew ( $t_{SKEW}$ ) vs. Supply Voltage



Figure 25. Propagation Delay Skew ( $t_{SKEW}$ ) vs. Temperature

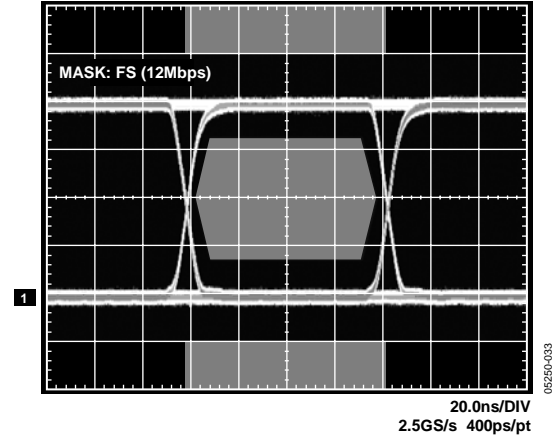

Figure 26. Eye Pattern, 12 Mbps,  $V_{DD} = 4.2 V$ ,  $T_A = 85^\circ C$ , PRBS 31

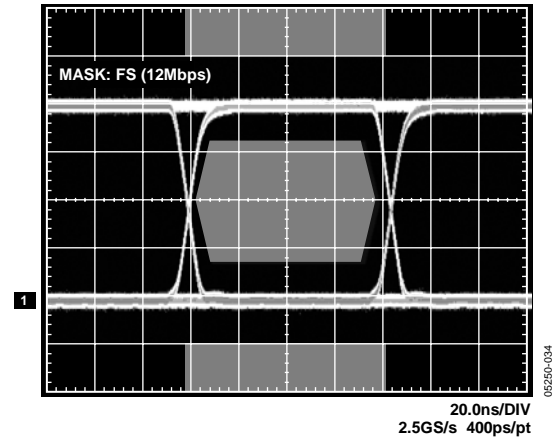

Figure 27. Eye Pattern, 12 Mbps,  $V_{DD} = 4.2 V$ ,  $T_A = -40^\circ C$ , PRBS 31

TEST CIRCUITS



Figure 28. On Resistance

05250-016



Figure 29. Off Leakage

05250-017



Figure 30. On Leakage

05250-018



Figure 31. Switching Times,  $t_{ON}$ ,  $t_{OFF}$

05250-019

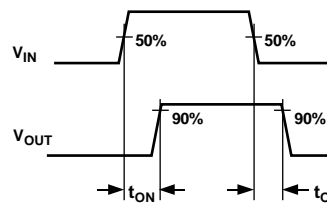

Figure 32. Break-Before-Make Time Delay,  $t_{BBM}$

05250-020

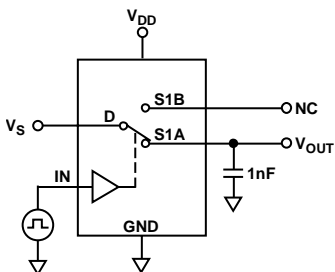
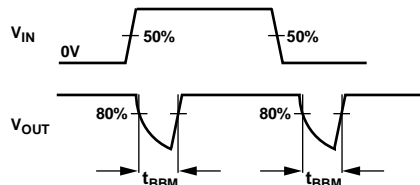
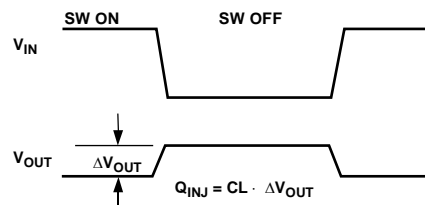

Figure 33. Charge Injection

05250-021



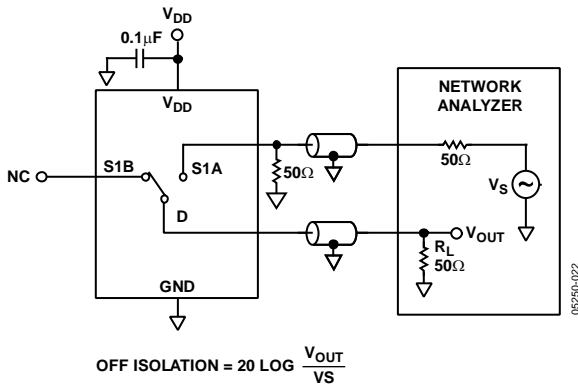

Figure 34. Off Isolation



Figure 36. Bandwidth



Figure 35. Channel-to-Channel Crosstalk (S1A to S1B)

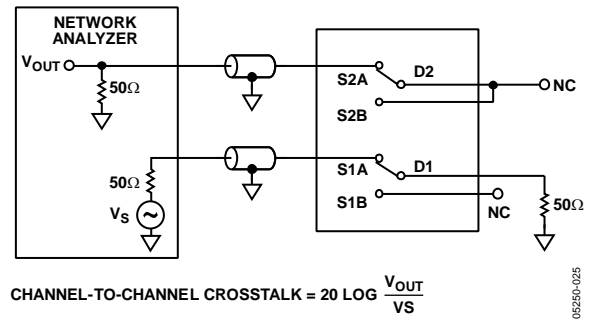

Figure 37. Channel-to-Channel Crosstalk (S1A to S2A)

## TERMINOLOGY

### $I_{DD}$

Positive supply current.

### $V_D (V_S)$

Analog voltage on Terminal D and Terminal S.

### $R_{ON}$

Ohmic resistance between D and S.

### $R_{FLAT (ON)}$

Flatness is defined as the difference between the maximum and minimum value of on resistance as measured.

### $\Delta R_{ON}$

On resistance match between any two channels.

### $I_S (OFF)$

Source leakage current with the switch off.

### $I_D (OFF)$

Drain leakage current with the switch off.

### $I_D, I_S (ON)$

Channel leakage current with the switch on.

### $V_{INL}$

Maximum input voltage for Logic 0.

### $V_{INH}$

Minimum input voltage for Logic 1.

### $I_{INL} (I_{INH})$

Input current of the digital input.

### $C_S (OFF)$

Off switch source capacitance. Measured with reference to ground.

### $C_D (OFF)$

Off switch drain capacitance. Measured with reference to ground.

### $C_D, C_S (ON)$

On switch capacitance. Measured with reference to ground.

### $C_{IN}$

Digital input capacitance.

### $t_{ON}$

Delay time between the 50% and the 90% points of the digital input and switch on condition.

### $t_{OFF}$

Delay time between the 50% and the 90% points of the digital input and switch off condition.

### $t_{BBM}$

On or off time measured between the 80% points of both switches when switching from one to another.

### Charge Injection

A measure of the glitch impulse transferred from the digital input to the analog output during on-off switching.

### Off Isolation

A measure of unwanted signal coupling through an off switch.

### Crosstalk

A measure of unwanted signal that is coupled from one channel to another as a result of parasitic capacitance.

### -3 dB Bandwidth

The frequency at which the output is attenuated by 3 dB.

### On Response

The frequency response of the on switch.

### Insertion Loss

The loss due to the on resistance of the switch.

### THD + N

The ratio of the harmonic amplitudes plus noise of a signal, to the fundamental.

### $T_{SKEW}$

The measure of the variation in propagation delay between each channel.

### Rise Time Delay

The rise time of a signal is a measure of the time for the signal to rise from 10% of the ON level to 90% of the ON level. Rise time delay is the difference between the rise time, measured at the input, and the rise time, measured at the output.

### Fall Time Delay

The fall time of a signal is a measure of the time for the signal to fall from 90% of the ON level to 10% of the ON level. Fall time delay is the difference between the fall time, measured at the input, and the fall time, measured at the output.

### Rise-Time-to-Fall-Time Mismatch

This is the absolute value between the variation in the fall time and the rise time, measured at the output.

OUTLINE DIMENSIONS



Figure 38. 10-Lead Lead Frame Chip Scale Package [LFCSP\_WD]  
 3 mm × 3 mm Body, Very, Very Thin, Dual Lead (CP-10-9)  
 Dimensions shown in millimeters



COMPLIANT TO JEDEC STANDARDS MO-187-BA

Figure 39. 10-Lead Mini Small Outline Package [MSOP]  
 (RM-10)

Dimensions shown in millimeters



111105-0

Figure 40. 10-Ball Wafer Level Chip Scale Package [WLCSP]  
(CB-10)  
Dimensions shown in millimeters

### ORDERING GUIDE

Model	Temperature Range	Package Description	Package Option	Branding <sup>1</sup>
ADG787BRMZ <sup>2</sup>	-40°C to +85°C	10-Lead Mini Small Outline Package (MSOP)	RM-10	SM1
ADG787BRMZ-500RL <sup>2</sup>	-40°C to +85°C	10-Lead Mini Small Outline Package (MSOP)	RM-10	SM1
ADG787BRMZ-REEL <sup>2</sup>	-40°C to +85°C	10-Lead Mini Small Outline Package (MSOP)	RM-10	SM1
ADG787BCBZ-500RL <sup>2</sup>	-25°C to +85°C	10-Ball Wafer Level Chip Scale Package (WLCSP)	CB-10	S04
ADG787BCBZ-REEL <sup>2</sup>	-25°C to +85°C	10-Ball Wafer Level Chip Scale Package (WLCSP)	CB-10	S04
ADG787BCPZ-500RL <sup>2</sup>	-40°C to +85°C	10-Lead Lead Frame Chip Scale Package (LFCSP_WD)	CP-10-9	SM1
ADG787BCPZ-REEL <sup>2</sup>	-40°C to +85°C	10-Lead Lead Frame Chip Scale Package (LFCSP_WD)	CP-10-9	SM1

<sup>1</sup> Due to space constraints, branding on this package is limited to three characters.

<sup>2</sup> Z = Pb-free part.

**ADG787**

**NOTES**



# Mouser Electronics

Authorized Distributor

Click to View Pricing, Inventory, Delivery & Lifecycle Information:

[Analog Devices Inc.:](#)

[ADG787BCBZ-500RL7](#) [ADG787BCBZ-REEL7](#) [ADG787BRMZ](#) [ADG787BRMZ-500RL7](#) [ADG787BRMZ-REEL](#)  
[ADG787BCPZ-500RL7](#) [ADG787BCPZ-REEL](#) [ADG787BCBZ-REEL](#)