

All rights reserved, Copyright Kradex 2017		
Product model	Enclosure Z37 - Assembly	
Format: A3	Material: PS, ABS	
Scale 1:2	Tolerance: +/- 0.8	

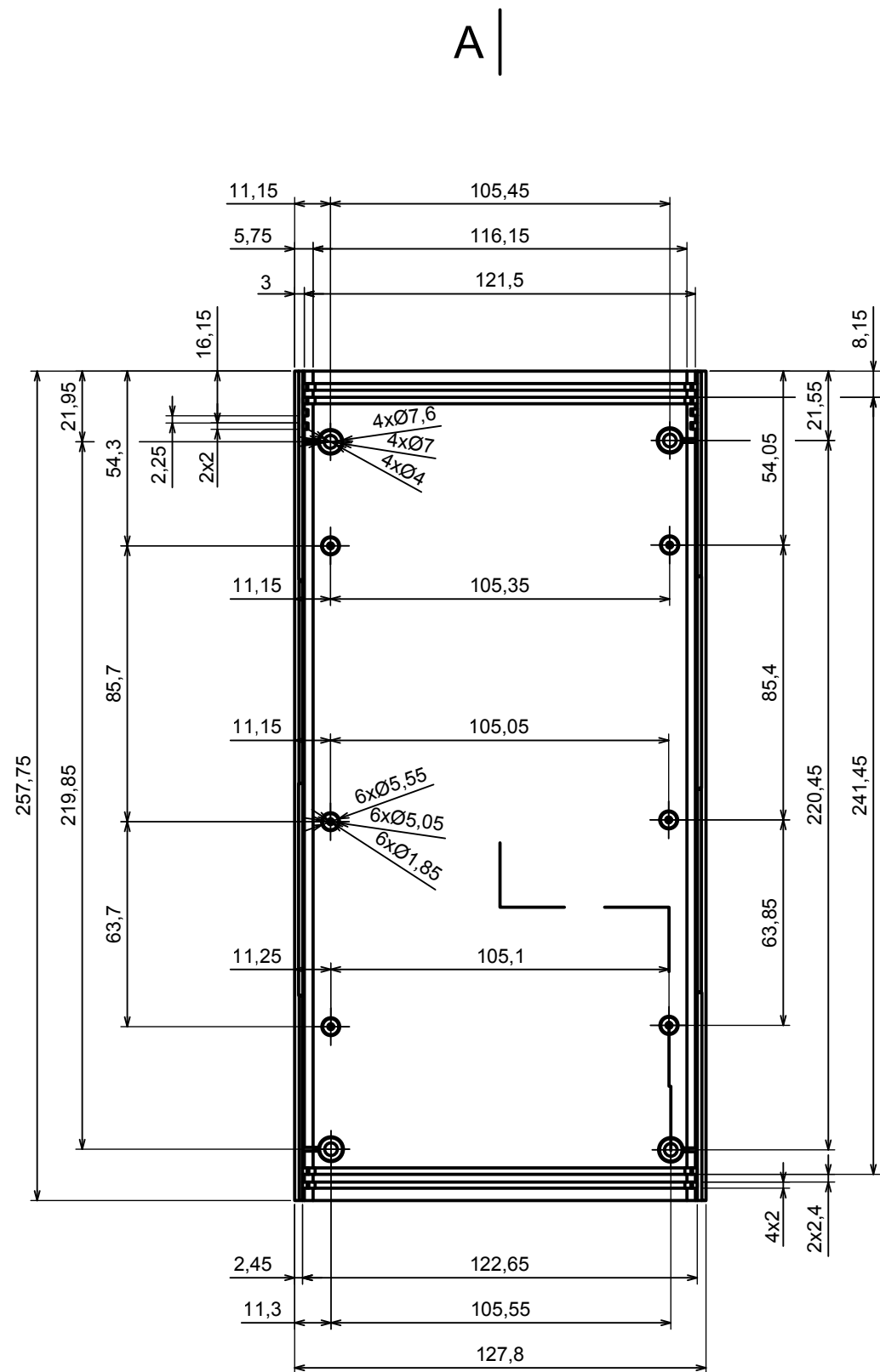

A-A

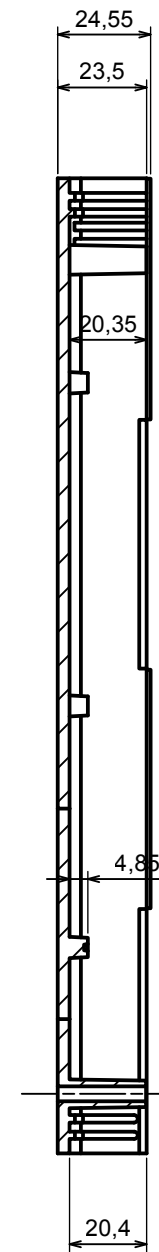

A |

All rights reserved, Copyright Kradox 2017

Product model: Enclosure Z37 - Base

Format: A3 | Material: PS, ABS

Scale 1:2 | Tolerance: +/- 0.8



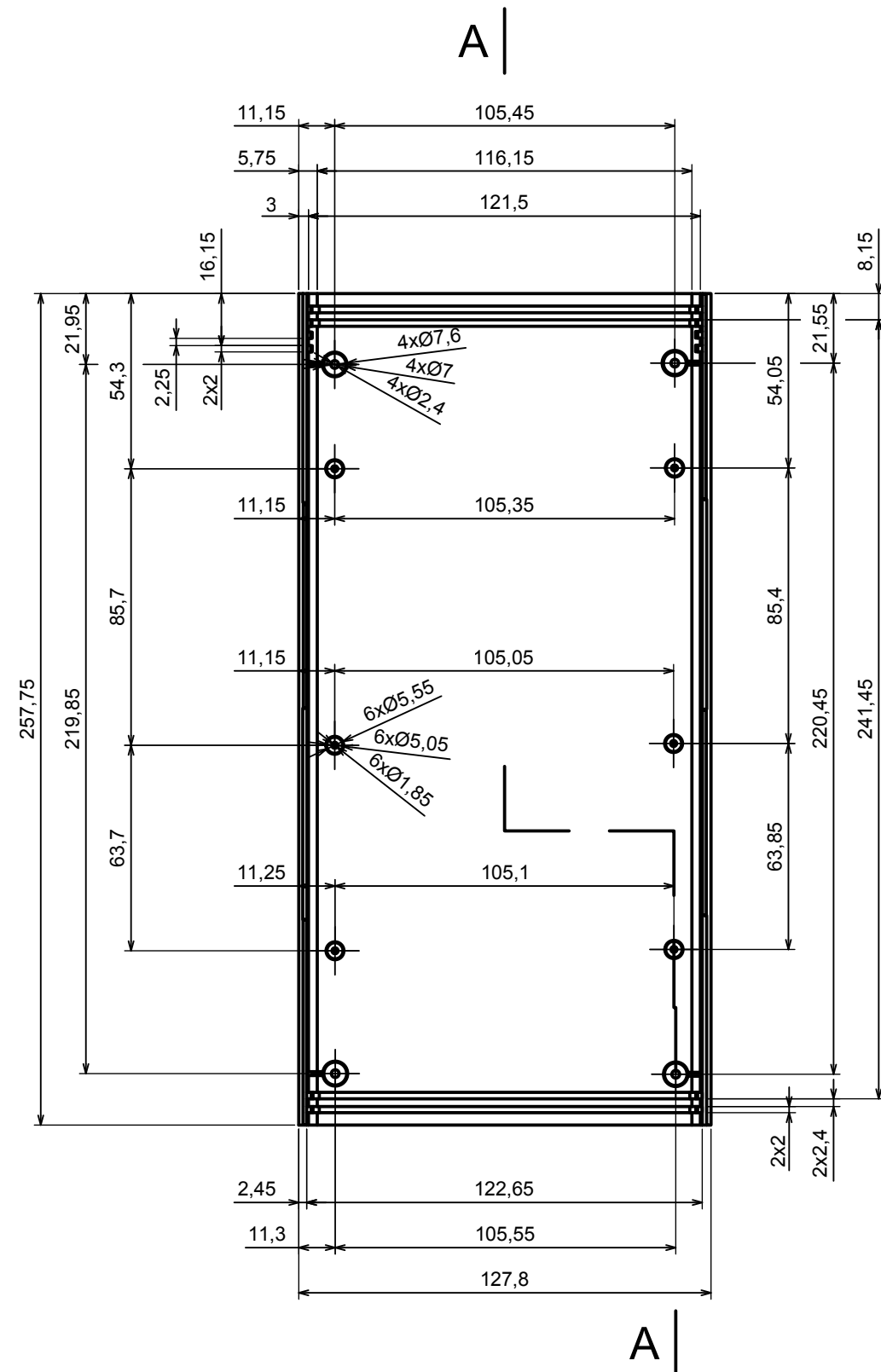

A-A

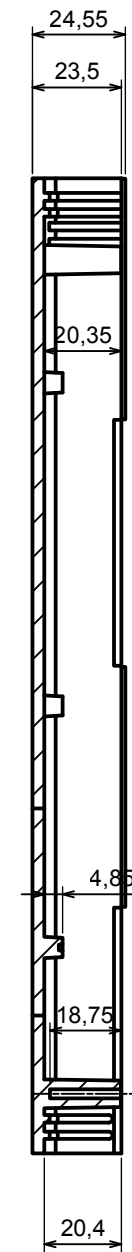

All rights reserved, Copyright Kradox 2017

Product model Enclosure Z37 - Cover

Format: A3 Material: PS, ABS

Scale 1:2 Tolerance: +/- 0.8



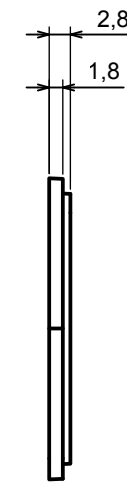
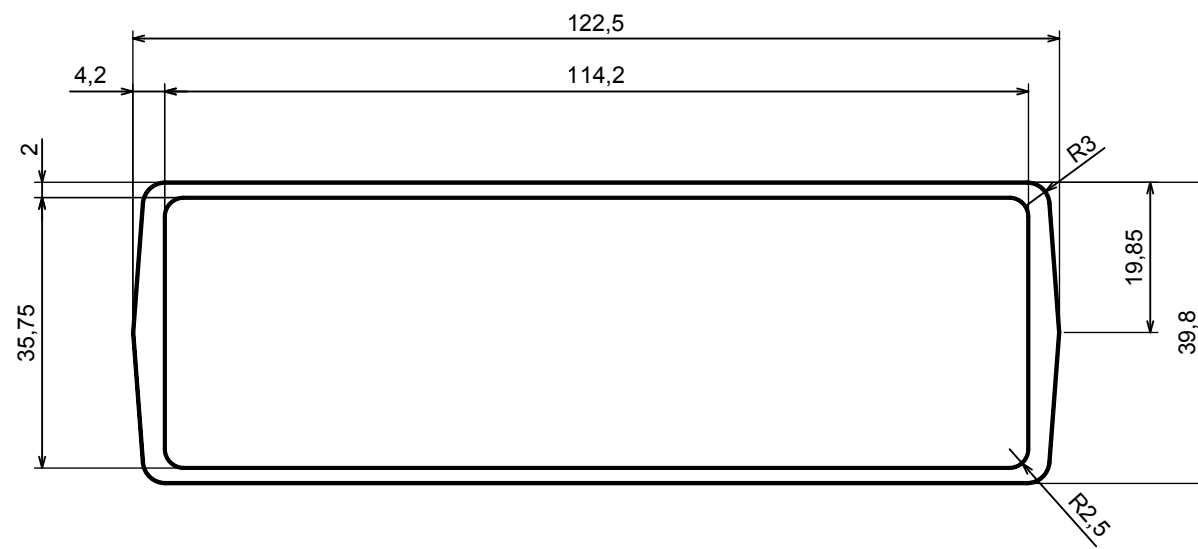

All rights reserved, Copyright Kradex 2017

Product model: Enclosure Z37 - Board

Format: A3 Material: PS, ABS

Scale 1:1 Tolerance: +/- 0.8



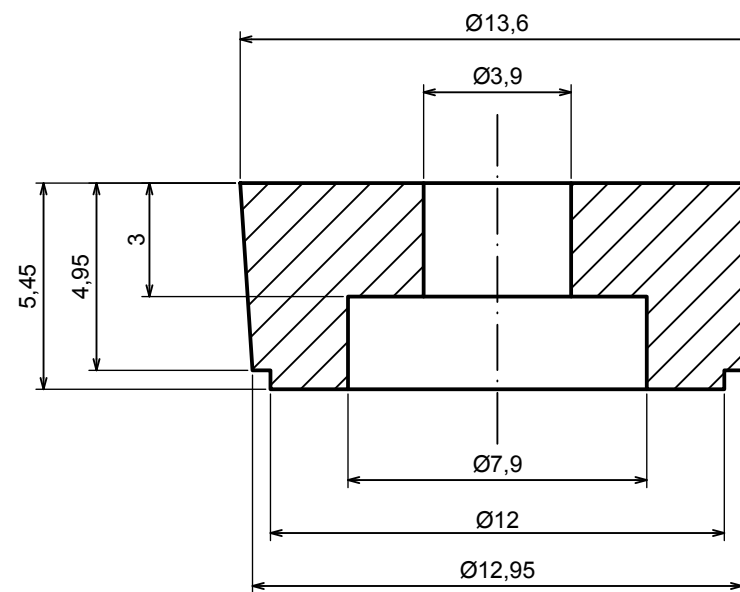

All rights reserved, Copyright Kradex 2017

Product model: Enclosure Z37 - Foot

Format: A3 Material: PS, ABS

Scale 5:1 Tolerance: +/- 0.5

