



## LM358

## LINEAR INTEGRATED CIRCUIT

### DUAL OPERATIONAL AMPLIFIER

#### DESCRIPTION

The UTC **LM358** consists of two independent high gain, internally frequency compensated operational amplifier. It can be operated from a single power supply and also split power supplies.

#### FEATURES

- \*Internally frequency compensated for unity gain.
- \*Wide power supply range 3V - 32V.
- \*Input common-mode voltage range include ground.
- \*Large DC voltage gain.

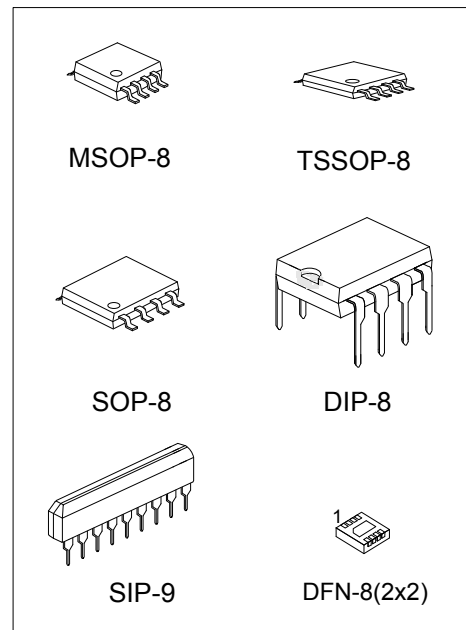

#### ORDERING INFORMATION

Ordering Number		Package	Packing
Lead Free	Halogen-Free		
LM358L-D08-T	LM358G-D08-T	DIP-8	Tube
-	LM358G-G09-T	SIP-9	Tube
-	LM358G-P08-R	TSSOP-8	Tape Reel
-	LM358G-S08-R	SOP-8	Tape Reel
-	LM358G-SM1-R	MSOP-8	Tape Reel
-	LM393G-K08-2020-R	DFN-8(2x2)	Tape Reel

<p>LM358L-D08-T</p> <p>(1) Packing Type (2) Package Type (3) Green Package</p>	<p>(1) T: Tube, R: Tape Reel (2) D08: DIP-8, G09: SIP-9, S08: SOP-8, P08: TSSOP-8, SM1: MSOP-8, K08-2020: DFN-8(2x2) (3) L: Lead Free, G: Halogen Free and Lead Free</p>
--	--

#### MARKING

DIP-8	SOP-8/MSOP-8	TSSOP-8
<p>UTC □□□□ LM358 □ □ □ □ □</p> <p>8 7 6 5 → Date Code 1 2 3 4 → Lot Code</p> <p>L: Lead Free G: Halogen Free</p>	<p>UTC □□□□ LM358G □ □ □</p> <p>8 7 6 5 → Date Code 1 2 3 4 → Lot Code</p>	<p>UTC □□□□ LM358G □ □ □</p> <p>8 7 → Date Code 1 2 3 4 → Lot Code</p>
SIP-9	DFN-8(2x2)	
<p>UTC □□□□ LM358G □ □ □</p> <p>9 8 7 6 5 4 3 2 1 → Date Code 1 2 3 4 5 6 7 8 9 → Lot Code</p>	<p>M58C □□□□ □ □ □ □ → Date Code</p>	

## ■ PIN DESCRIPTION

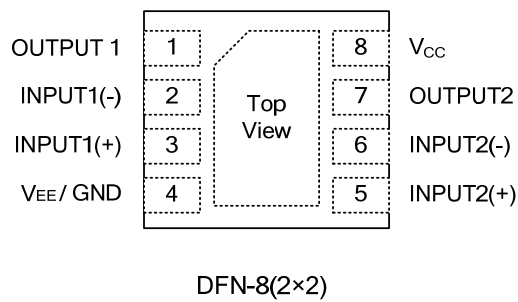
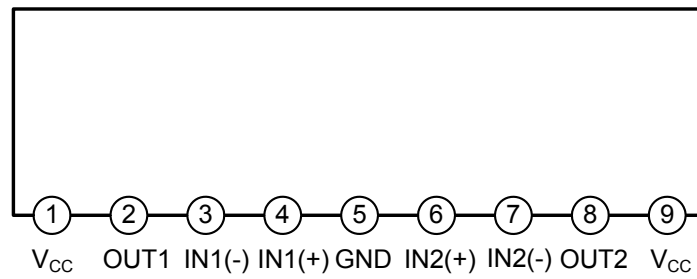
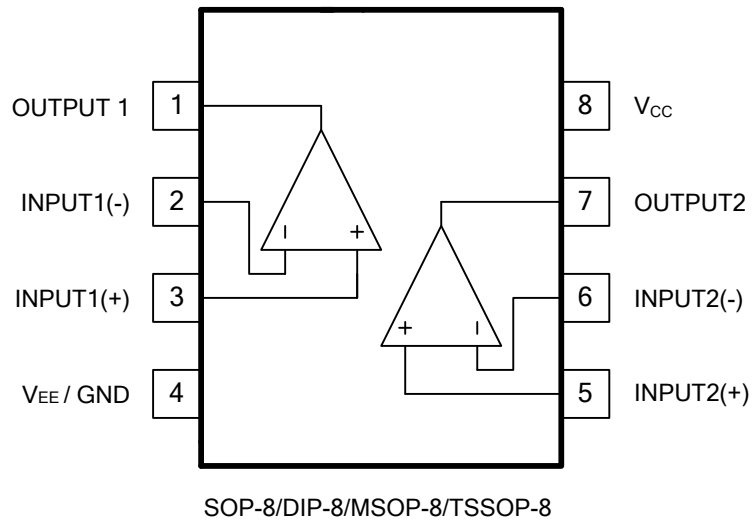

■ BLOCK DIAGRAM

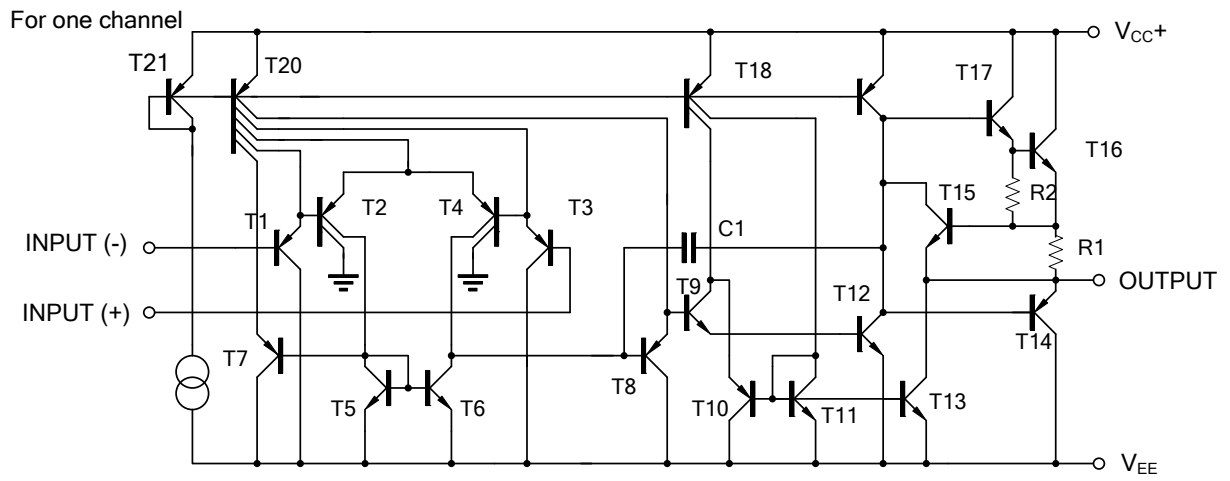

### ■ ABSOLUTE MAXIMUM RATINGS

PARAMETER		SYMBOL	RATINGS	UNIT
Supply Voltage		$V_{CC}$	$\pm 16$ or 32	V
Differential Input Voltage		$V_{I(DIFF)}$	$\pm 32$	V
Input Voltage		$V_I$	-0.3 ~ +32	V
Output Short to Ground			Continuous	
Power Dissipation	SIP-9	$P_D$	750	mW
	DIP-8		625	
	SOP-8		440	
	TSSOP-8		360	
	MSOP-8		300	
	DFN-8(2x2)		830	
Junction Temperature		$T_J$	+125	$^{\circ}\text{C}$
Operating Temperature (Note 2)		$T_{OPR}$	-40 ~ +105	$^{\circ}\text{C}$
Storage Temperature		$T_{STG}$	-65 ~ +150	$^{\circ}\text{C}$

Notes: 1. Absolute maximum ratings are those values beyond which the device could be permanently damaged.

Absolute maximum ratings are stress ratings only and functional device operation is not implied.

2. It is guarantee by design, not 100% be tested.

### ■ ELECTRICAL CHARACTERISTICS ( $V_{CC}=5.0\text{V}$ , $V_{EE}=\text{GND}$ , $T_A=25^{\circ}\text{C}$ , unless otherwise specified)

PARAMETER	SYMBOL	TEST CONDITIONS	MIN	TYP	MAX	UNIT
Input Offset Voltage	$V_{I(OFF)}$	$V_{CM}=0\text{V to }V_{CC}-1.5\text{V}$ $V_{O(P)}=1.4\text{V}$ , $R_S=0\Omega$		2.0	5.0	mV
Input Common Mode Voltage	$V_{I(CM)}$	$V_{CC}=30\text{V}$	0		$V_{CC}-1.5$	V
Differential Input Voltage	$V_{I(DIFF)}$				$V_{CC}$	V
Output Voltage Swing	$V_{OH}$	$V_{CC}=30\text{V}$ , $R_L=2\text{K}\Omega$	26			V
		$V_{CC}=30\text{V}$ , $R_L=10\text{K}\Omega$	27	28		V
	$V_{OL}$	$V_{CC}=5\text{V}$ , $R_L \geq 10\text{K}\Omega$		5	20	mV
Large Signal Voltage Gain	$G_V$	$V_{CC}=15\text{V}$ , $R_L \geq 2\text{K}\Omega$ $V_{O(P)}=1\text{V} \sim 11\text{V}$	25	100		V/mV
Power Supply Current	$I_{CC}$	$R_L=\infty$ , $V_{CC}=30\text{V}$		0.8	2.0	mA
		$R_L=\infty$ , Full Temperature Range		0.5	1.2	mA
Input Offset Current	$I_{I(OFF)}$			5	50	nA
Input Bias Current	$I_{I(BIAS)}$			45	250	nA
Short Circuit Current to Ground	$I_{SC}$			40	70	mA
Output Current	$I_{SOURCE}$	$V_I(+)=1\text{V}$ , $V_I(-)=0\text{V}$ $V_{CC}=15\text{V}$ , $V_{O(P)}=2\text{V}$	10	30		mA
		$V_I(+)=0\text{V}$ , $V_I(-)=1\text{V}$ $V_{CC}=15\text{V}$ , $V_{O(P)}=2\text{V}$	10	15		mA
	$I_{SINK}$	$V_I(+)=0\text{V}$ , $V_I(-)=1\text{V}$ $V_{CC}=15\text{V}$ , $V_{O(P)}=200\text{mV}$	12	100		$\mu\text{A}$
Common Mode Rejection Ratio	CMRR		65	80		dB
Power Supply Rejection Ratio	PSRR		65	100		dB
Channel Separation	CS	$f=1\text{KHZ} \sim 20\text{KHZ}$		120		dB

## TYPICAL CHARACTERISTICS

Fig.1 Input Voltage Range

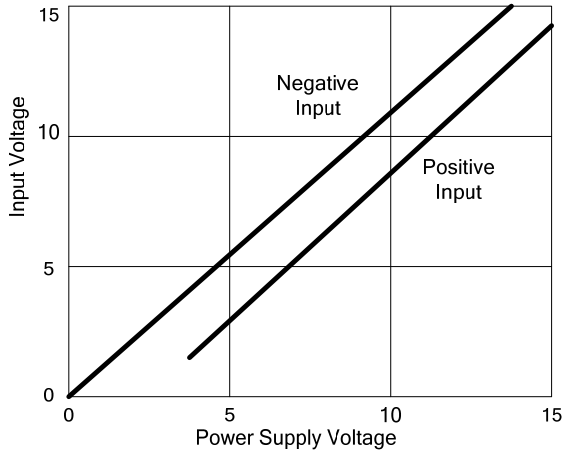

Fig.2 Input Current vs Temperature

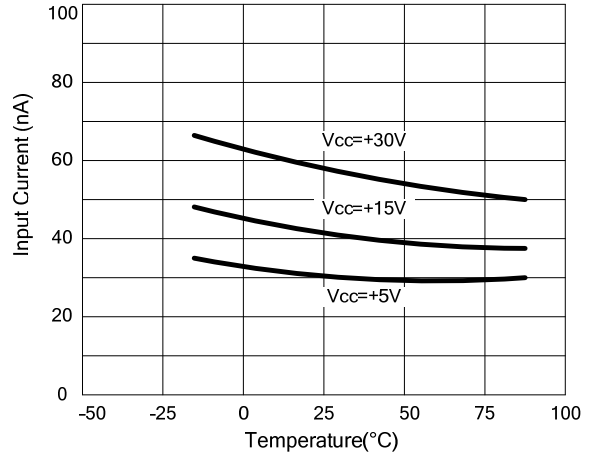

Fig.3 Supply Current vs Supply Voltage

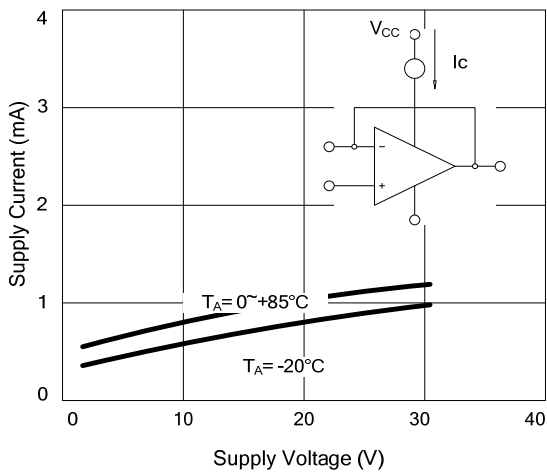

Fig. 4 Voltage Gain vs Supply Voltage

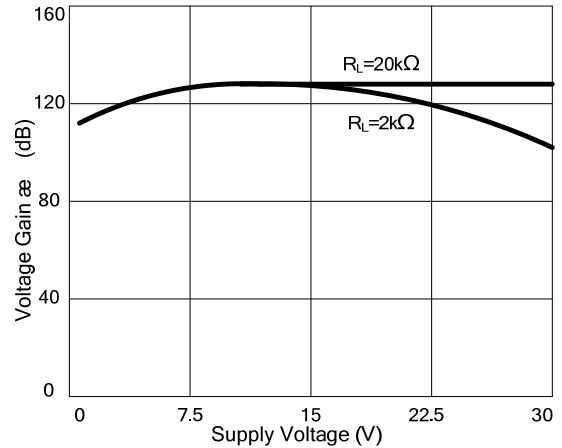

Fig. 5 Open Loop Gain vs Frequency

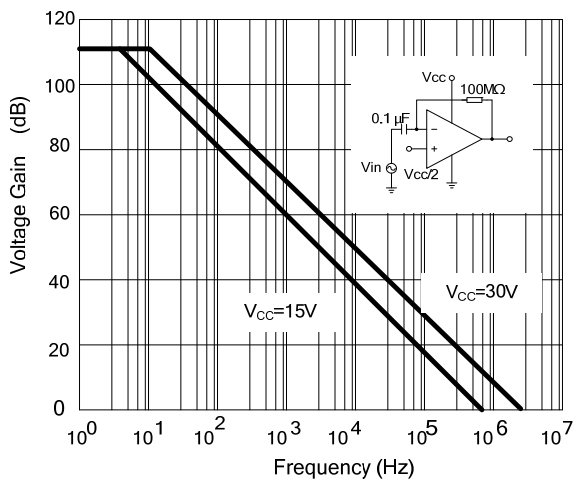
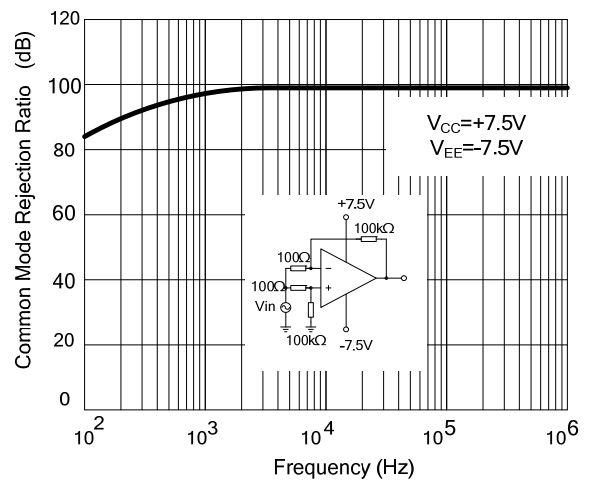

Fig. 6 Common Mode Rejection Ratio vs Frequency



## TYPICAL CHARACTERISTICS(Cont.)

Fig. 7 Voltage Follower Pulse Response

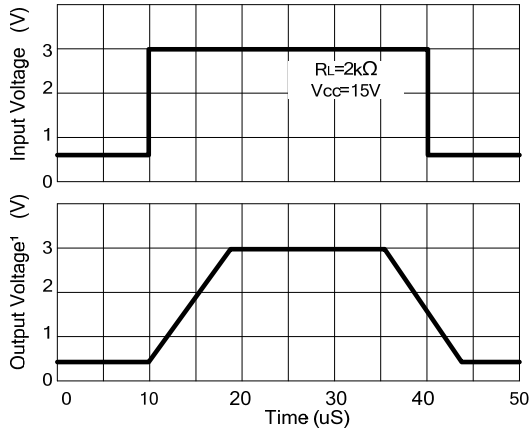

Fig. 8 Voltage Follower Response (Small Signal)

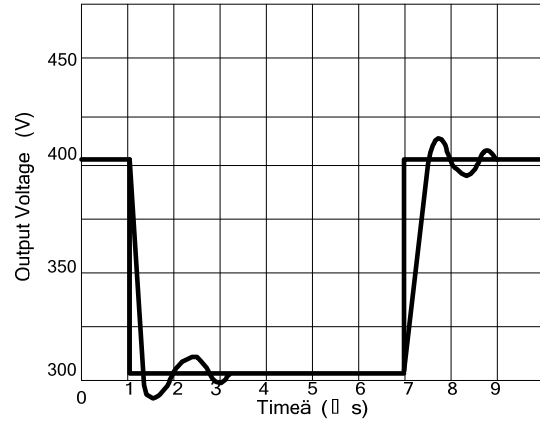

Fig. 9 Gain vs Large Signal Frequency

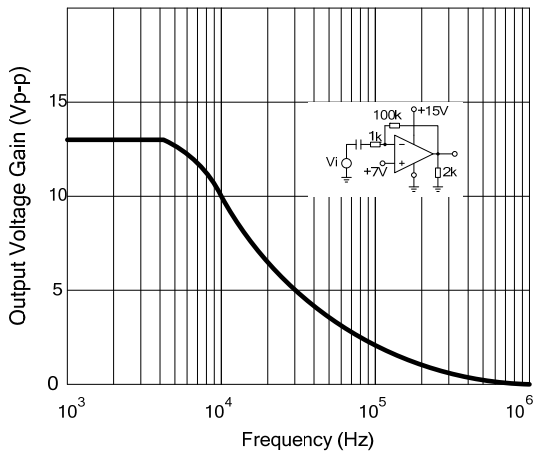

Fig. 10 Output Source Current vs Output Voltage

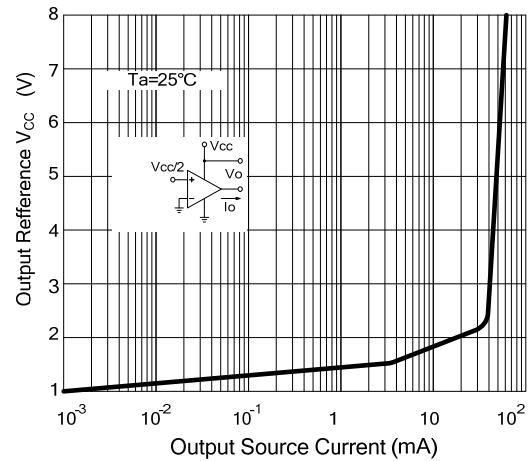

Fig. 11 Output Sink Current vs Output Voltage

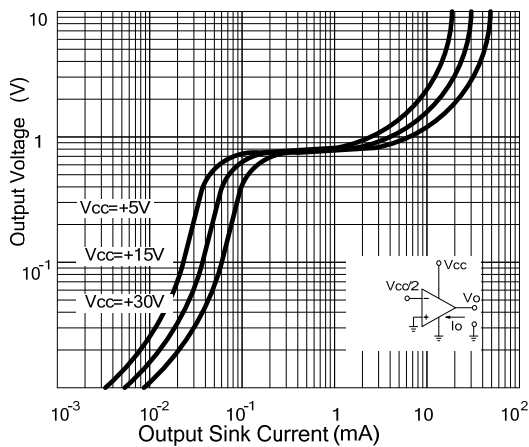
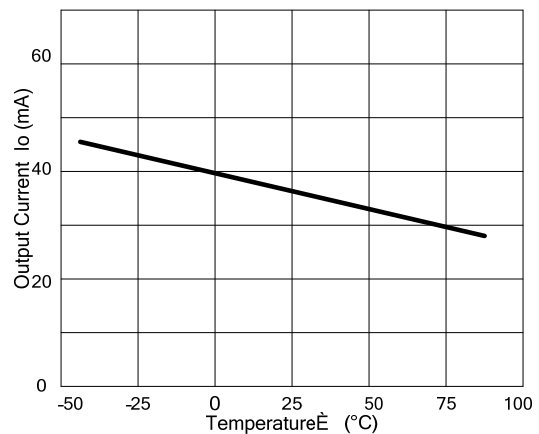

Fig.12 Current Limiting vs Temperature



UTC assumes no responsibility for equipment failures that result from using products at values that exceed, even momentarily, rated values (such as maximum ratings, operating condition ranges, or other parameters) listed in products specifications of any and all UTC products described or contained herein. UTC products are not designed for use in life support appliances, devices or systems where malfunction of these products can be reasonably expected to result in personal injury. Reproduction in whole or in part is prohibited without the prior written consent of the copyright owner. The information presented in this document does not form part of any quotation or contract, is believed to be accurate and reliable and may be changed without notice.