

TO-92 D`UghjWEncapsulate Voltage Regulators

CJ79L15 Three-terminal negative voltage regulator

FEATURES

- Maximum output current
I_{OM}: 0.1A
- Output voltage
V_O: -1.5 V
- Continuous total dissipation
P_D:0.625 W (T_a= 25 °C)

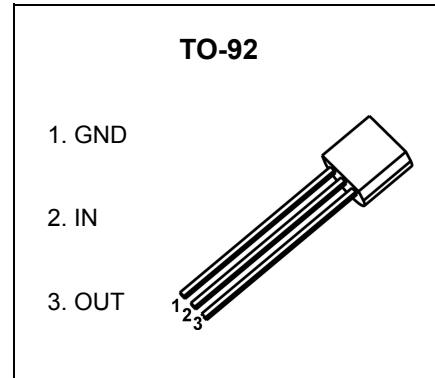

ABSOLUTE MAXIMUM RATINGS (Operating temperature range applies unless otherwise specified)

Parameter	Symbol	Value	Unit
Input Voltage	V _i	-35	V
Thermal Resistance from Junction to Ambient	R _{θJA}	200	°C/W
Operating Junction Temperature Range	T _{OPR}	0~+150	°C
Storage Temperature Range	T _{STG}	-65~+150	°C

ELECTRICAL CHARACTERISTICS AT SPECIFIED VIRTUAL JUNCTION TEMPERATURE (V_i=-23V, I_o=40mA, C_i=0.33μF, C_o=0.1μF, unless otherwise specified) .

Parameter	Symbol	Test conditions	Min	Typ	Max	Unit	
Output voltage	V _o	25°C	-14.4	-15	-15.6	V	
		-17.5V≤V _i ≤-30V, I _o =1mA~40mA	0-125°C	-14.25	-15	-15.75	V
		I _o =1mA~70mA		-14.25	-15	-15.75	V
Load Regulation	ΔV _o	I _o =1mA~100mA, V _i =-23V	25°C	25	150	mV	
		I _o =1mA~40mA, V _i =-23V	25°C	15	75	mV	
Line regulation	ΔV _o	-17.5V≤V _i ≤-30V, I _o =40mA	25°C	65	300	mV	
		-20V≤V _i ≤-30V, I _o =40mA	25°C	50	250	mV	
Quiescent Current	I _q		25°C		6.5	mA	
Quiescent Current Change	ΔI _q	-20V≤V _i ≤-30V, I _o =40mA	0-125°C		1.5	mA	
	ΔI _q	1mA≤I _o ≤40mA	0-125°C		0.1	mA	
Output Noise Voltage	V _N	10Hz≤f≤100KHz	25°C	90		μV/V _o	
Ripple Rejection	RR	-18.5V≤V _i ≤-28.5V, f=120Hz	0-125°C	34	39	dB	
Dropout Voltage	V _d		25°C	1.7		V	

* Pulse test.

TYPICAL APPLICATION

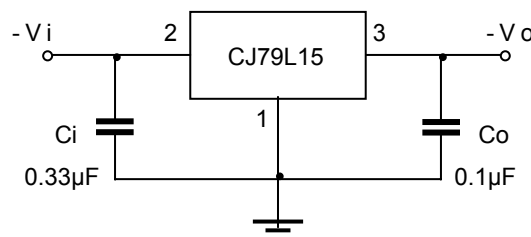

Note: Bypass capacitors are recommended for optimum stability and transient response and should be located as close as possible to the regulators.

Typical Characteristics

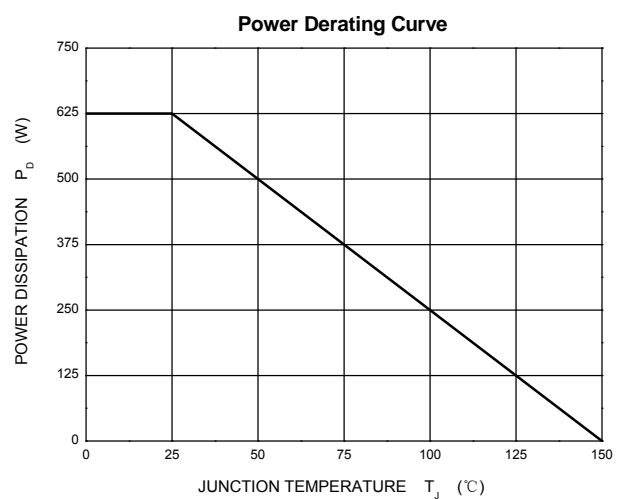
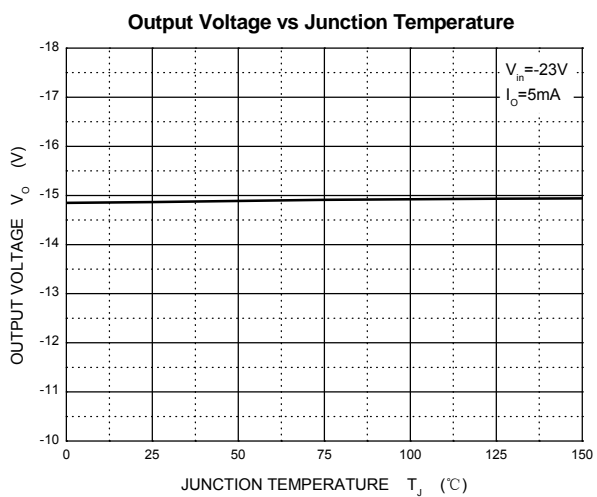
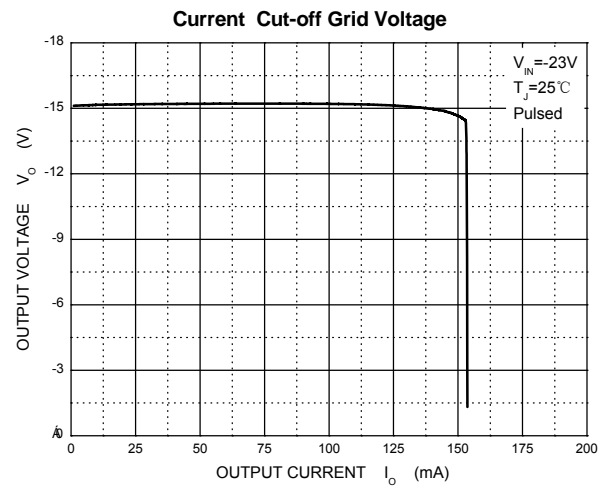
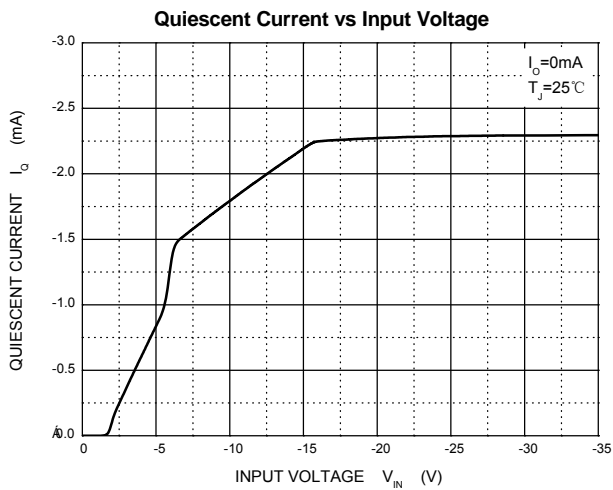
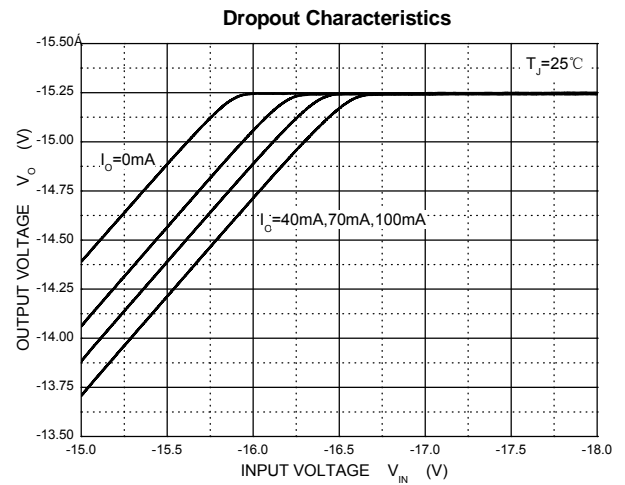
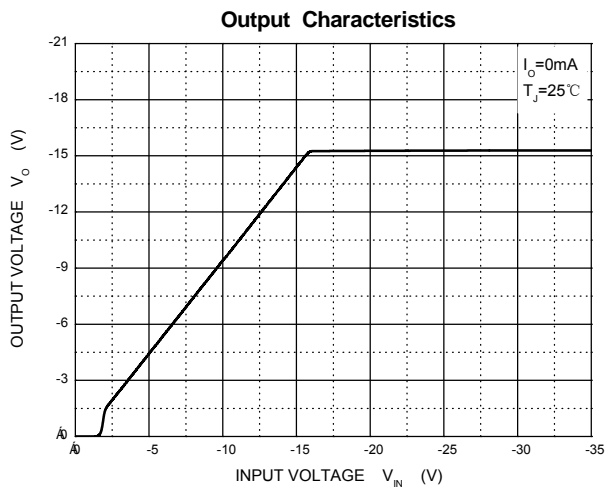

TO-92 Package Outline Dimensions

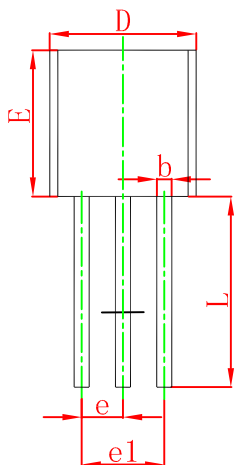
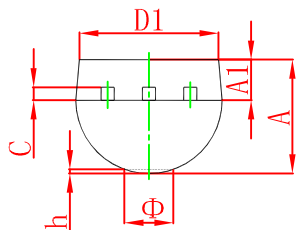

Symbol	Dimensions In Millimeters		Dimensions In Inches	
	Min	Max	Min	Max
A	3.300	3.700	0.130	0.146
A1	1.100	1.400	0.043	0.055
b	0.380	0.550	0.015	0.022
c	0.360	0.510	0.014	0.020
D	4.400	4.700	0.173	0.185
D1	3.430		0.135	
E	4.300	4.700	0.169	0.185
e	1.270 TYP		0.050 TYP	
e1	2.440	2.640	0.096	0.104
L	14.100	14.500	0.555	0.571
Φ		1.600		0.063
h	0.000	0.380	0.000	0.015

TO-92 Suggested Pad Layout

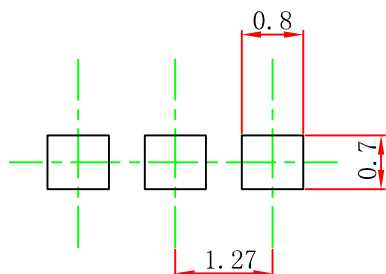

Note:

1. Controlling dimension: in millimeters.
2. General tolerance: $\pm 0.05\text{mm}$.
3. The pad layout is for reference purposes only.

NOTICE

JCET reserve the right to make modifications, enhancements, improvements, corrections or other changes without further notice to any product herein. JCET does not assume any liability arising out of the application or use of any product described herein.

TO-92 PACKAGE TAPEING DIMENSION

TO-92 PACKAGE TAPEING DIMENSION



Dimensions are in millimeter

A1	A	T	P	P0	P2	F1	F2	W
4.5	4.5	3.5	12.7	12.7	6.35	2.5	2.5	18.0
W0	W1	W2	H	H0	D0	t1	t2	ΔP
6.0	9.0	1.0 MAX.	19.0	16.0	4.0	0.4	0.2	0

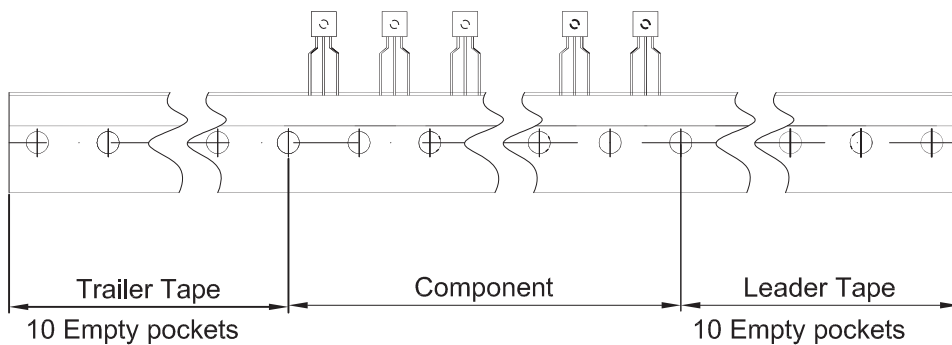

Package	Box	Box Size(mm)	Carton	Carton Size(mm)
TO-92	2000 pcs	333×162×43	20,000 pcs	350×340×250